

東莞永力電業有限公司

YUNG LI CO., LTD

Da Pu Industrial Zone, Gang Zi, Changping Town,
Dong Guan City, Guangdong 523571 China.P.R.C

TEL:0769-83396797~8

FAX:0769-83396796

E-mail: sales@yung-li.com

Description: YP-FH/YC-1D^

Customer: _SY

Parts No. : UI?`?e?KB

Draw No. :

REVISION RECORD

1		
2		
3		
4		
5		

YUNG LI	
CHECKED	PREPARED BY

CUSTOMER	APPROVED



N/17665

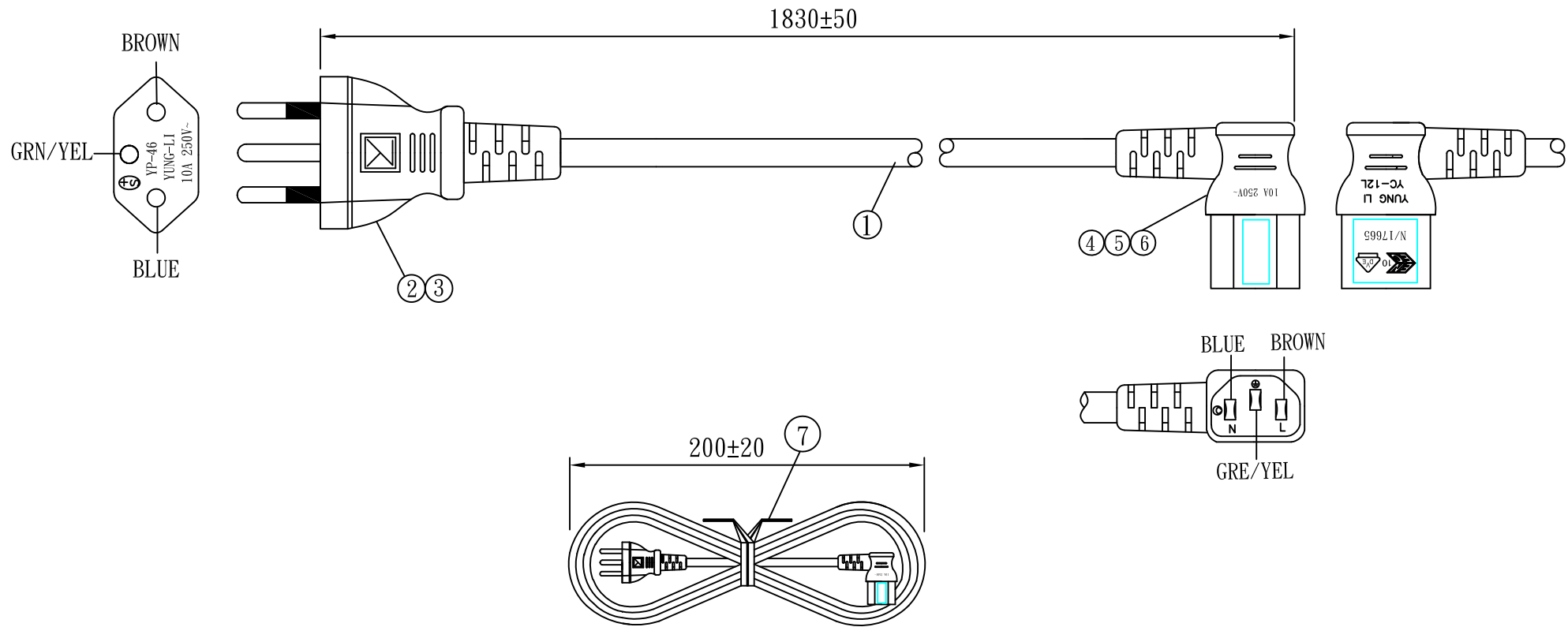

NO.	SPECIFICATION	Q' TY	REMARK
1	H05VV-F 0.75/3G BLACK	1PC	
2	YP-46 PVC PLASTIC:50P BLACK	18g/PC	
3	SWITZERLAND FRAME:P97005P-1B BLACK	1PC	
4	TER:97740	3PCS	
5	YC-12L INNER BODY	1PC	
6	YC-12L PVC PLASTIC:50P BLACK	18g/PC	
7	MINI TIE:L=130mm BLACK	1PC	

Tolerance >0±0.30 >1.0±0.50 >10.0±1.0 >20.0±2.0 Angle: ±1°	Approved		Date	YUNG LI CO.,LTD			
	Checked		Date				
	Drawn		Date	Customer	MAG		
	Cat. No.	YP-46/YC-12L		P/N.	CB-N-S-90		
	Drawing No.	CY-S0156	Rev.	B	Material	P.V.C	Unit
				Scale			

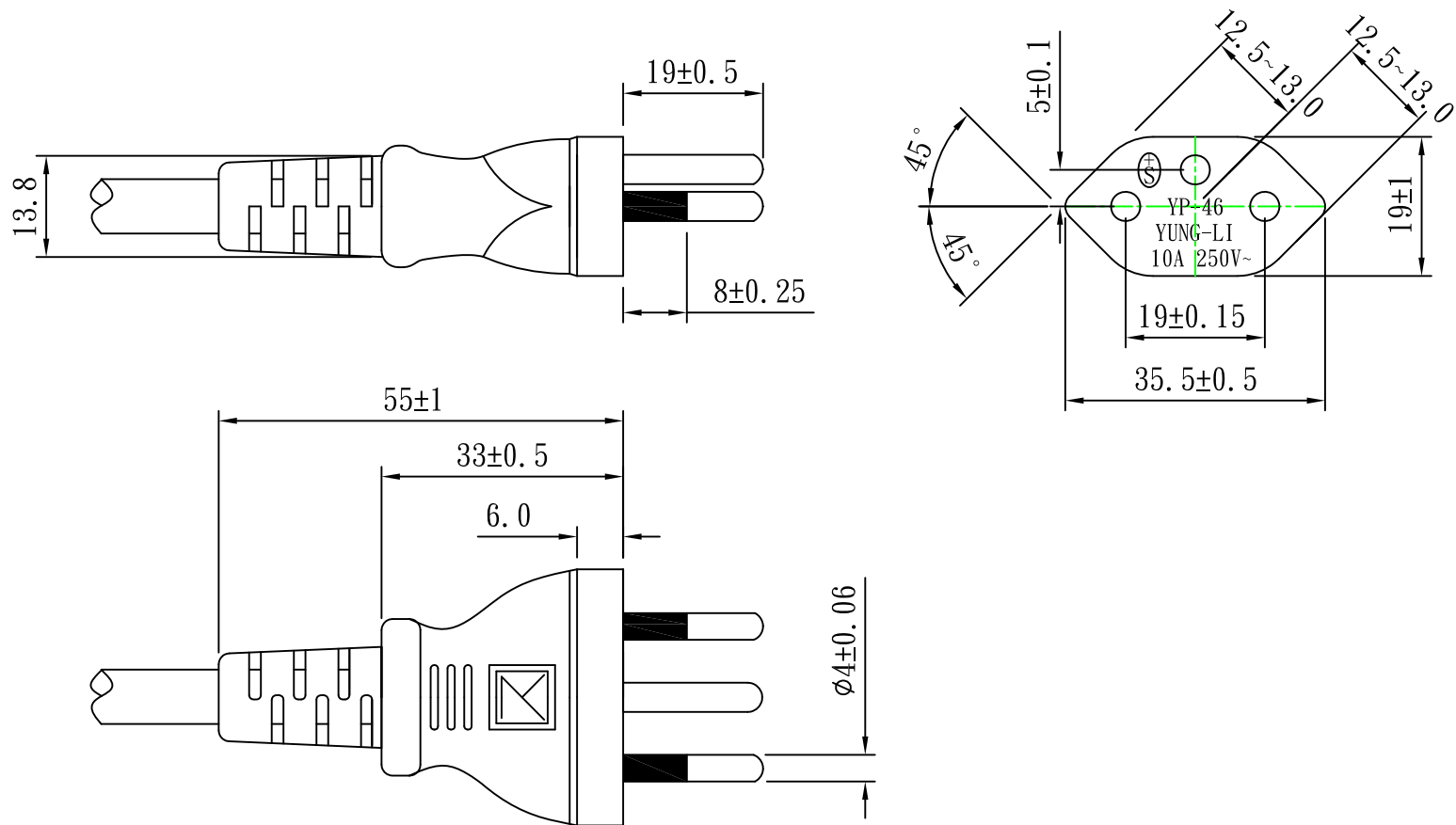

Tolerance $>0 \pm 0.30$ $>1.0 \pm 0.50$ $>10.0 \pm 1.0$ $>20.0 \pm 2.0$ Angle: $\pm 1^\circ$	Approved		Date		YUNG LI CO.,LTD			
	Checked		Date					
	Drawn		Date		Customer			
	Cat. No.	YP-46			P/N.			
	Drawing No.	CY-P46S	Rev.	B	Material	P. V. C	Unit	mm
					Scale			



N/17665

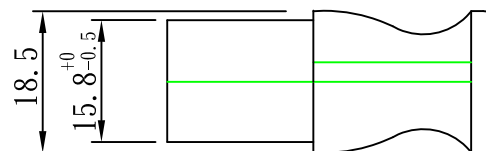
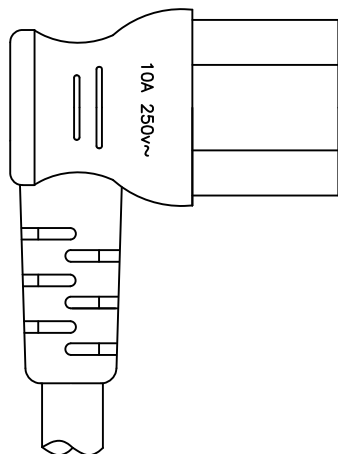
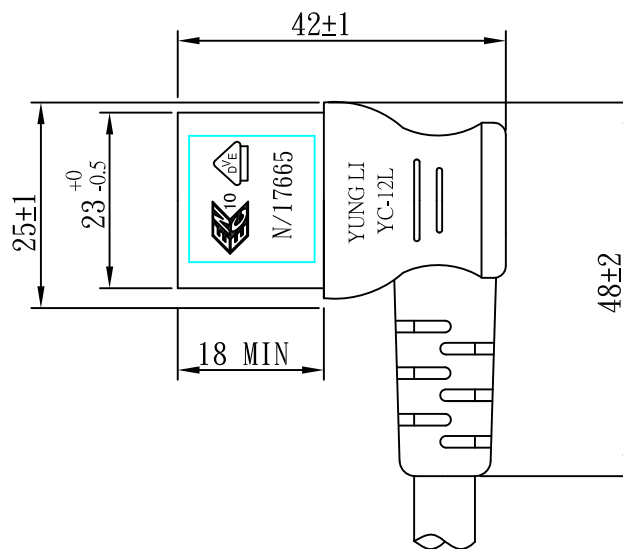
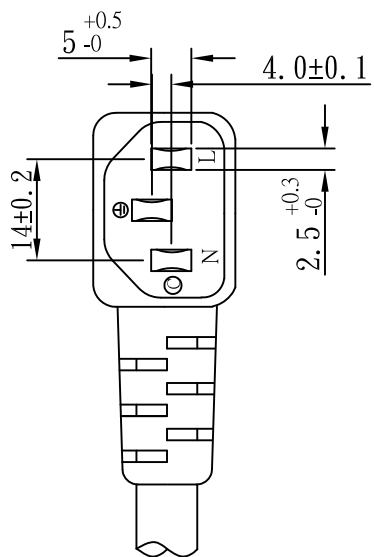

TOLERANCE $>0 \pm 0.30$ $>1.0 \pm 0.50$ $>10.0 \pm 1.0$ $>20.0 \pm 2.0$ Angle: $\pm 1^\circ$	APPROVED		DATE		YUNG LI CO., LTD					
	CHECKED		DATE							
	DRAWN		DATE		CUSTOMER					
	TYPE	YC-12L				P/N				
	DRAWING NO.	CY-C12LV	REV	B	MATERIAL	P. V. C	UNIT	mm		
				SCALE	1:1					

YUNG LI CO., LTD









SPECIFICATION

Yung Li	Style	PVC FLEXIBLE CORDS	Document No
2012.7.18			YL-V01001
Edition	Size	H05VV-F 3G 0.75mm²	Page
A			1/2

1. Standard: IEC 60227 IEC60228
 2. Construction & Dimension

	Item	Specification
Conductor	Size	3G 0.75mm ²
	Material	Annealed Bare Copper
	Construction	24/ § 0.2±0.01
Insulation	Material	PVC
	Minimum Average Thickness	0.60mm
	Minimum Thickness at any point	0.44mm
	Diameter	2.35 ± 0.10
	Identification	Blue,Brown, Yellow/Green
Core Assembly	Core Twist	3-Core
	Filler	NA
	Assembly Pair	NA
Taping	Mylar Foil	NA
Shielded	A1-Mylar Foil	NA
Drain	Material	NA
	Construction	NA
Jacket	Material	PVC
	Minimum Average Thickness	0.8mm
	Minimum Thickness at any point	0.58mm
	Overall Diameter(Approx)	6.7 ± 0.15
	Color	Any Color

Marking:

Yung Li Co., Ltd. H05VV-F 3G 0.75mm² <VDE> NF-USE 1347  KEMA-KEUR  <OVE>
     IEMMEQU Q04083  A004049 60227 IEC 53(RVV) 300/500V  SU01027-4002

YUNG LI CO., LTD

SPECIFICATION

Yung Li	Style	PVC FLEXIBLE CORDS	Document No
2012.7.18			YL-V01001
Edition	Size	H05VV-F 3G 0.75mm²	Page
A			2/2

4. Electrical & Physical Properties

Item	Specification		
Rating Voltage	70°C 300/500V		
Conductor resistance(AT 20°C)	26.0Ω/Km MAX		
Insulation Resistance(AT 70°C)	0.011MΩ/Km Min		
Dielectric Strength	AC 2.0 KV / 15 min No Break		
Spark Test	6.0KV		
Insulation	Unaged	Tensile Strength	1.02 kgf/mm ² min
		Elongation	150% Min
	Aged	Tensile Strength	80~120% (80°C x168hrs)
		Elongation	80~120% (80°C x168hrs)
	Loss of mass Test		2.0mg/cm ² (max)
Jacket	Unaged	Tensile Strength	1.02 kgf/mm ² min
		Elongation	150% Min
	Aged	Tensile Strength	80~120% (80°C x168hrs)
		Elongation	80~120% (80°C x168hrs)
	Loss of mass Test		2.0mg/cm ² (max)
Deformation Test		70±2°C X 4hr ≤ 50%	
Cold Bend Test		-15°C x 1hr No Crack	
Heat Shock Test		150±2°C x 1hr No Crack	

Graph:

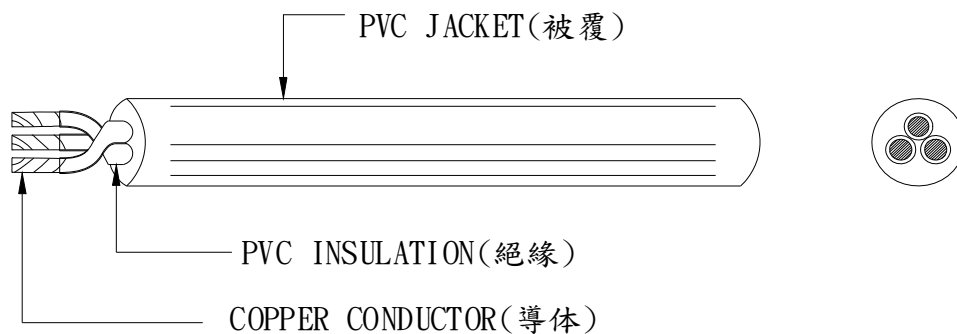



Yung Li Co., Ltd.
Da Pu Industrial Zone
Chang Ping Town
CN-Dongguan, Guangdong 523571
P.R. China

Client no.
125389

Your ref.
Robert Yung Li

Our Ref.
Gn

Date
2012/05/21

Authorization

Number: **12.0353**
valid until: **2015/05/20**

Marking:  Company Logo

Based on the documents contained in file **11-IK-0683** the Federal Inspectorate for Heavy Current Installations grants the firm named above the right, to put the equipment listed below on the market marked with the safety mark in accordance with the NEV.

Equipment: **Plug, non-rewirable**
Tradename: **YUNG LI**

Type designation: **YP-46**
Nominal values:
250V~ 10A L+N+PE
plug CH-type 12, standard sheet SEV 6534-2
with non-rewirable cords:
H05VV-F 3G0.75mm² [YUNG LI]
H05VV-F 3G1.00mm² [YUNG LI]
H05VV-F 3G1.50mm² [YUNG LI]

Protection class: for class I equipment
Protection degree: ordinary
Basis: Certificate / electrosuisse / IK-1925 dated 2012/05/15
Remark:
Test standards: IEC 60884-1(ed.3):02+A1:06
SEV 1011:09





Authorization

Number: **12.0353**

Page **2**

Federal Inspectorate for Heavy Current Installations ESTI

P. Fluri
Head of Market Surveillance/Authorization of the Safety Mark

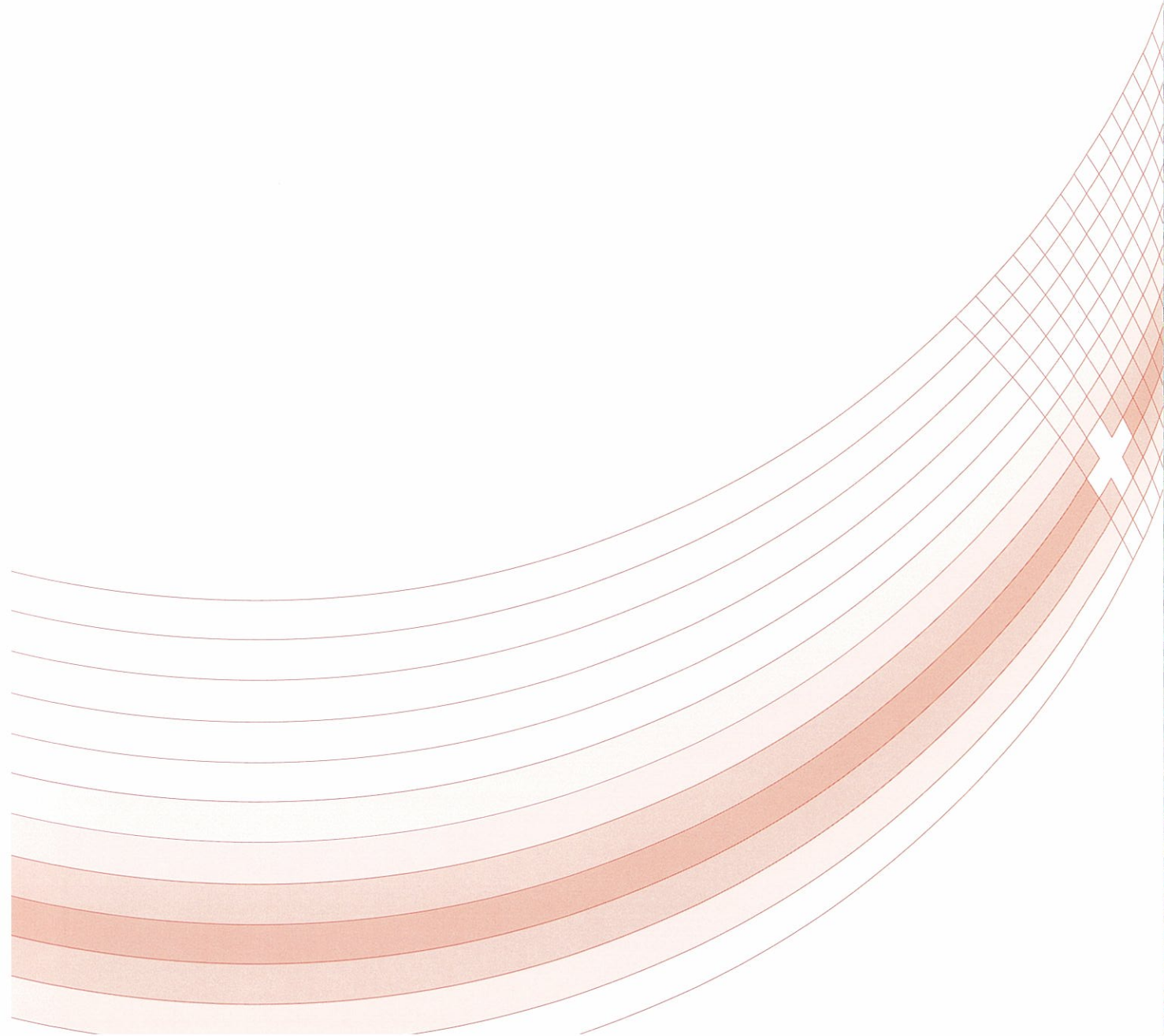

ZEICHENGENEHMIGUNG MARKS APPROVAL

Yung-Li Co. Ltd.
Da Pu Industrial Zone, Cang Zi
Chang Ping Town
523571 DONG GUAN CITY
Guangdong
CHINA

ist berechtigt, für ihr Produkt /
is authorized to use for their product

Gerätesteckdose, nicht-wiederanschließbar
Connector, non-rewirable

die hier abgebildeten markenrechtlich geschützten Zeichen
für die ab Blatt 2 aufgeführten Typen zu benutzen /
the legally protected Marks as shown below for the types referred to on page 2 ff.



Geprüft und zertifiziert nach /
Tested and certified according to

DIN EN 60320-1 (VDE 0625-1):2008-05; EN 60320-1:2001 + A1:2007

VDE Prüf- und Zertifizierungsinstitut GmbH
VDE Testing and Certification Institute
Zertifizierungsstelle / Certification

VDE Zertifikate sind nur gültig bei Veröffentlichung unter:
VDE certificates are valid only when published on:

VDE

Aktenzeichen: 1609800-1550-0003 / 148086

File ref.:

Ausweis-Nr. 40029577

Blatt 1

Certificate No.

Page

Weitere Bedingungen siehe Rückseite und Folgebätter /
further conditions see overleaf and following pages

Offenbach, 2010-03-05

(letzte Änderung/updated 2011-08-16)

<http://www.vde.com/zertifikat>

<http://www.vde.com/certificate>



Name und Sitz des Genehmigungs-Inhabers / *Name and registered seat of the Certificate holder*

Yung-Li Co. Ltd., Da Pu Industrial Zone, Gang Zi, Chang Ping Town, 523571 DONG GUAN CITY,
Guangdong, CHINA

Aktenzeichen / *File ref.*

1609800-1550-0003 / 148086 / FG31 / E

letzte Änderung / *updated* Datum / *Date*

2011-08-16 2010-03-05

Dieses Blatt gilt nur in Verbindung mit Blatt 1 des Zeichengenehmigungsausweises Nr. 40029577
This supplement is only valid in conjunction with page 1 of the Certificate No. 40029577.

Gerätesteckdose, nicht-wiederanschließbar
Connector, non-rewirable

Typ(en) / *Type(s)*:

- 1) YC-12
- 2) YC-12L

Bemessungsspannung
Rated voltage

AC 250 V

Bemessungsstrom
Rated current

10 A

Polzahl
Number of poles

2-polig mit Schutzkontakt
2-pole with earthing contact

Bauart
Kind of construction

Normblatt C13
standard sheet C13

Warenzeicheninhaber
Trademark holder

Yung Li Co. Ltd.

Produktinformation
Product information

siehe Anlage Nr. 300 + 400 + 900
see Appendix No. 300 + 400 + 900

PAK

Das Produkt entspricht den Anforderungen gemäß PAK-Dokument
ZEK 01.2-08.

PAH

*The product is in accordance with the requirements of
PAH-document ZEK 01.2-08.*

Fortsetzung siehe Blatt 3 /
continued on page 3

VDE Prüf- und Zertifizierungsinstitut

Aktenzeichen: **1609800-1550-0003/148086**
 File reference: **1609800-1550-0003/148086**

Ausweis-Nr.: **40029577**
 Certificate No.: **40029577**

Anlage Nr.: **300**
 Appendix No.: **300**

Seite: **1 / 1**
 Page: **1 / 1**

Datum: **2011-08-16**
 Date: **2011-08-16**

Diese Anlage ist Bestandteil des Genehmigungsausweises. This appendix is part of the certificate.

Gerätesteckdose, nicht-wiederausziehbar
Connector, non-rewirable

2-polig mit Schutzkontakt
2-pole with earthing contact

zentrale Leitungseinführung
straight cable entry

Fertigungsstätte / Place of manufacture:

30008928 : Kennzeichnung / Identification : **Keine / without**

Werkstoff der Umspritzung: Typ: Farbe
 Material of the moulding: Type: colour

PVC, Typ(e) CS-9731-WB; alle Farben / all colours
 CHIA SHIN ENTERPRISES Co. Ltd.

Type without front cover:

Werkstoff der Trägartelle: Typ: Hersteller, Farbe
 Material of the base: Type: manufacturer, colour

Insert: PBT, Typ(e) 4115(a); weiß / white
 Chang Chun Plastics Co., Ltd. Front cover: PBT, Typ(e) 4115(a); black / schwarz
 Chang Chun Plastics Co., Ltd.

Type with front cover:

Inneneinsatz: Typ: Hersteller
 Insert: Type: manufacturer



Position im VDE-Ausweis Position in VDE-licence		X <input checked="" type="checkbox"/> Δ genehmigte Ausführung / approved version			--- <input type="checkbox"/> Δ nicht genehmigt / not approved		
Typ(en) Type(s)	Leitungsaufdruck Marking on cable						
YC-12	YUNG LI	X	H05VV-F 3G 0,75 mm ² (max. 2 m)	X	H05VV-F 3G 1,0 mm ²	X	H05VV-F 3G 1,5 mm ²
YC-12	WONDERFUL Yong Tai	X	H05RR-F 3G 0,75 mm ² (max. 2 m)	X	H05RR-F 3G 1,0 mm ²	X	H05RR-F 3G 1,5 mm ²
		X	H05RN-F 3G 0,75 mm ² (max. 2 m)	X	H05RN-F 3G 1,0 mm ²		
			H03RT-H 3G 0,75 mm ² (max. 2 m)		H03RT-H 3G 1,0 mm ²		
		X	H05V2V2-F 3G 0,75 mm ² (max. 2 m)	X	H05V2V2-F 3G 1,0 mm ²	X	H05V2V2-F 3G 1,5 mm ²



VDE Prüf- und Zertifizierungsinstitut

Aktenzeichen: **1609800-1550-0003/148086**
 File reference:

Ausweis-Nr.: **40029577**
 Certificate No.:

Anlage Nr.: **400**
 Appendix No.:

Seite: **1 / 1**
 Page:

Datum: **2011-08-16**
 Date:

Diese Anlage ist Bestandteil des Genehmigungsausweises. *This appendix is part of the certificate.*

Gerätesteckdose, nicht-wiederanschließbar
Connector, non-rewirable

2-polig mit Schutzkontakt
2-pole with earthing contact

abgewinkelt Leitungseinführung
angled cable entry

Fertigungsstätte / Place of manufacture:

30008928 : Kennzeichnung / Identification : **Keine / without**

Werkstoff der Umspritzung: Typ: Farbe
 Material of the moulding: Type; colour

PVC, Typ(e) CS-9731-WB; alle Farben / all colours
 CHIA SHIN ENTERPRISES Co. Ltd.

Type without cover of insert:

Type with cover of insert:

Werkstoff der Trägereile: Typ; Hersteller; Farbe
 Material of the base: Type; manufacturer; colour

Insert:
 PBT, Typ(e) 4115(a); weiß / white
 Chang Chun Plastics Co.,Ltd.

Front cover:
 PBT, Typ(e) 4115(a); black / schwarz
 Chang Chun Plastics Co.,Ltd.

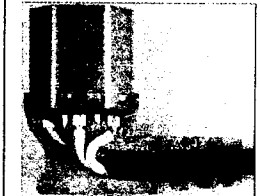
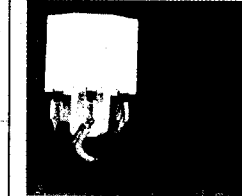

Inneneinsatz: Typ; Hersteller
 Insert: Type; manufacturer

Position im VDE-Ausweis Position in VDE-licence	Typ(en) Type(s)	Leitungsaufdruck Marking on cable	X <u>Δ</u> genehmigte Ausführung / approved version													--- <u>Δ</u> nicht genehmigt / not approved																						
			H05VV-F 3G 0,75 mm ² (max. 2 m)	H05VV-F 3G 1,0 mm ²	H05VV-F 3G 1,5 mm ²	H05RR-F 3G 0,75 mm ² (max. 2 m)	H05RR-F 3G 1,0 mm ²	H05RR-F 3G 1,5 mm ²	H05RN-F 3G 0,75 mm ² (max. 2 m)	H05RN-F 3G 1,0 mm ²	H03RT-H 3G 0,75 mm ² (max. 2 m)	H03RT-H 3G 1,0 mm ²	H05V2V2-F 3G 0,75 mm ² (max. 2 m)	H05V2V2-F 3G 1,0 mm ²	H05V2V2-F 3G 1,5 mm ²																							
2)	YC-12L	YUNG LI	X	X	X	--	--	--	--	--	--	X	X	X	--	--	--	--	--	--	--	--	--	--	--	--	--	--	--	--	--	--	--	--	--	--	--	
2)	YC-12L	I-SHENG	X	X	X	--	--	--	--	--	--	--	--	--	--	--	--	--	--	--	--	--	--	--	--	--	--	--	--	--	--	--	--	--	--	--	--	
2)	YC-12L	WONDERFUL Yong Tai	--	--	--	X	X	X	X	X	--	--	--	--	--	--	--	--	--	--	--	--	--	--	--	--	--	--	--	--	--	--	--	--	--	--	--	--

VDE Prüf- und Zertifizierungsinstitut

ZEICHENGENEHMIGUNG MARKS APPROVAL

Yung-Li Co. Ltd.
Da Pu Industrial Zone, Cang Zi
Chang Ping Town
523571 DONG GUAN CITY
Guangdong
CHINA

ist berechtigt, für ihr Produkt /
is authorized to use for their product

Flexible Leitung
Flexible cable (cord)

die hier abgebildeten markenrechtlich geschützten Zeichen
für die ab Blatt 2 aufgeführten Typen zu benutzen /
the legally protected Marks as shown below for the types referred to on page 2 ff.



oder/or



oder/or



Gepprüft und zertifiziert nach /
Tested and certified according to

DIN VDE 0281-5 (VDE 0281 Teil 5):2002-09; HD 21.5 S3:1994 + A1:1999 + A2:2001

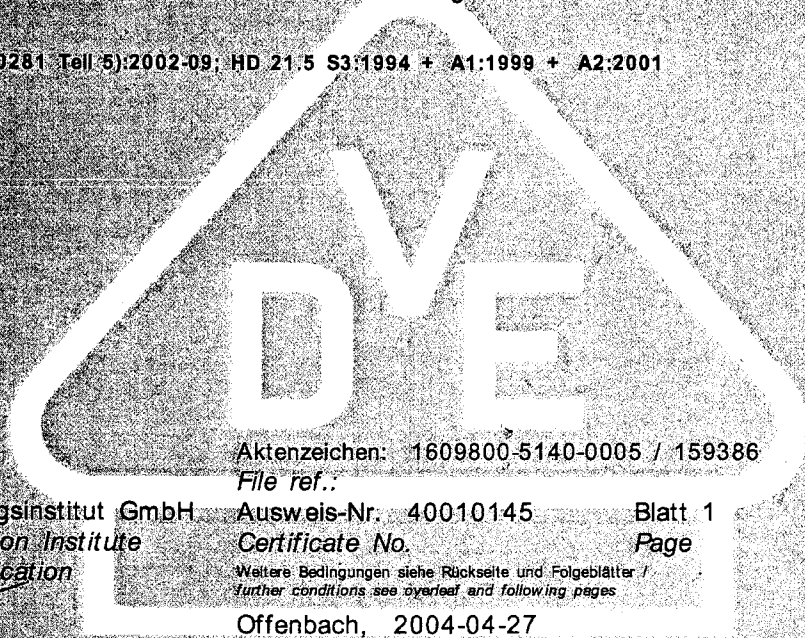

Aktenzeichen: 1609800-5140-0005 / 159386

File ref..

VDE Prüf- und Zertifizierungsinstitut GmbH
VDE Testing and Certification Institute
Zertifizierungsstelle / Certification

Ausweis-Nr. 40010145

Blatt 1

Certificate No.

Page

Weitere Bedingungen siehe Rückseite und Folgeblätter /
further conditions see overleaf and following pages

Offenbach, 2004-04-27

(letzte Änderung/updated 2012-03-27)

K. Prohaska

VDE Zertifikate sind nur gültig bei Veröffentlichung unter:
VDE certificates are valid only when published on:

<http://www.vde.com/zertifikat>

<http://www.vde.com/certificate>

VDE



VDE Prüf- und Zertifizierungsinstitut Zeichengenehmigung

Ausweis-Nr. / Blatt /
Certificate No. page
40010145 2

Name und Sitz des Genehmigungs-Inhabers / *Name and registered seat of the Certificate holder*
Yung-Li Co. Ltd., Da Pu Industrial Zone, Cang Zi, Chang Ping Town, 523571 DONG GUAN CITY,
Guangdong, CHINA

Aktenzeichen / *File ref.*
1609800-5140-0005 / 159386 / FG42 / STR

letzte Änderung / *updated* Datum / *Date*
2012-03-27 2004-04-27

Dieses Blatt gilt nur in Verbindung mit Blatt 1 des Zeichengenehmigungsausweises Nr. 40010145
This supplement is only valid in conjunction with page 1 of the Certificate No. 40010145.

Flexible Leitung *Flexible cable (cord)*

Typ(en) / *Type(s)*:

H03VV-F 2...4 x 0,5...0,75 mm ²	+
H03VVH2-F 2 x 0,5...0,75 mm ²	+
H05VV-F 2...5 x 0,75...4 mm ²	+
H05VVH2-F 2 x 0,75...1,0 mm ²	+

Firmenzeichen YUNG LI
Trademark

Dieser Zeichengenehmigungs-Ausweis bildet eine Grundlage für die EG-Konformitätserklärung und CE-Kennzeichnung durch den Hersteller oder dessen Bevollmächtigten und bescheinigt die Konformität mit den grundlegenden Schutzanforderungen der **EG-Niederspannungsrichtlinie 2006/95/EG** mit ihren Änderungen.

This Marks Approval is a basis for the EC Declaration of Conformity and the CE Marking by the manufacturer or his agent and proves the conformity with the essential safety requirements of the EC Low-Voltage Directive 2006/95/EC including amendments.

VDE Prüf- und Zertifizierungsinstitut GmbH
VDE Testing and Certification Institute
Fachgebiet FG42
Section FG42