

MARKING: YL-6123 YUNG LI 13/250~ BS1363/A

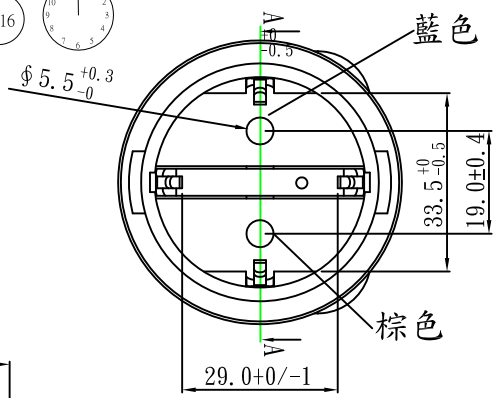

Note:
 1. Rating: 13A 250V~
 2. Insulation Resistance: 100MΩ
 3. Dielectric Voltage: 2000V/sec

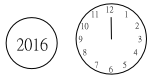
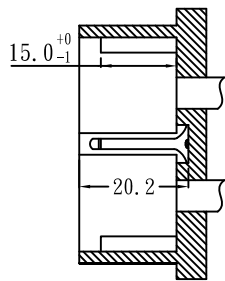

A--A(局部)

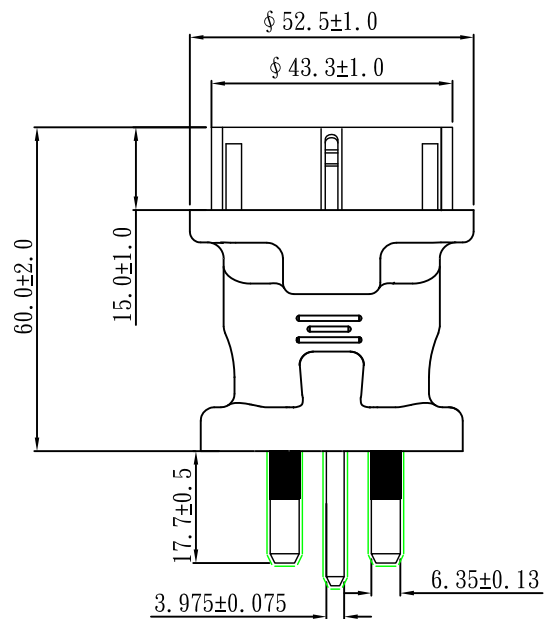

以進料點為起點, 平齊此處貼標籤, 文字方向如圖.

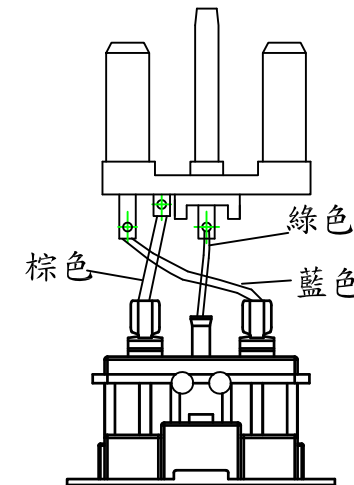
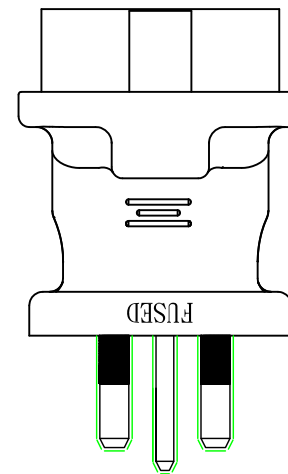
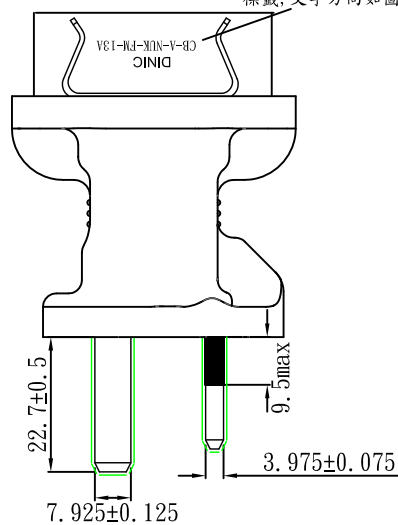

接線圖如上:
 YC-23地線朝下

每30個裝一袋, 貼一張標籤.
 包裝打印

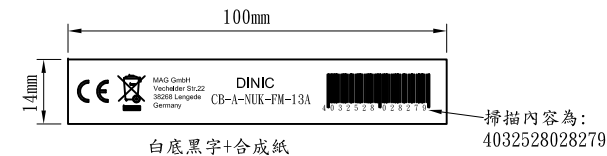
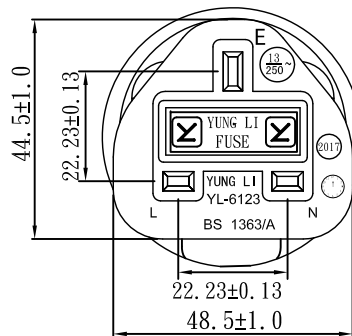
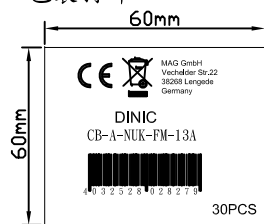

白底黑字+合成紙

TOLERANCE >0±0.30 >1.0±0.50 >10.0±1.0 >20.0±2.0 Angle: ±1°	APPROVED		DATE		YUNG LI CO., LTD		
	CHECKED		DATE				
	DRAWN	SUKI	DATE	21.10.29	CUSTOMER	MAG	
	TYPE	YL-6123			P/N	CB-A-NUK-FM-13A	
	DRAWING NO.	CY-A6123-05	REV	B	MATERIAL	P.V.C	UNIT
				HEFT(g)	114		