

# 東莞永力電業有限公司

YUNG LI CO., LTD

Da Pu Industrial Zone, Gang Zi, Changping Town,  
Dong Guan City, Guangdong 523571 China.P.R.C

TEL:0769-83396797~8

FAX:0769-83396796

E-mail: sales@yung-li.com

Description: YP-22/YC-12L

Customer: MAG

Parts No. : CB-N-90L

Draw No. :

## *REVISION RECORD*

1		
2		
3		
4		
5		

YUNG LI	
CHECKED	PREPARED BY

CUSTOMER	APPROVED



10 DE N/17665

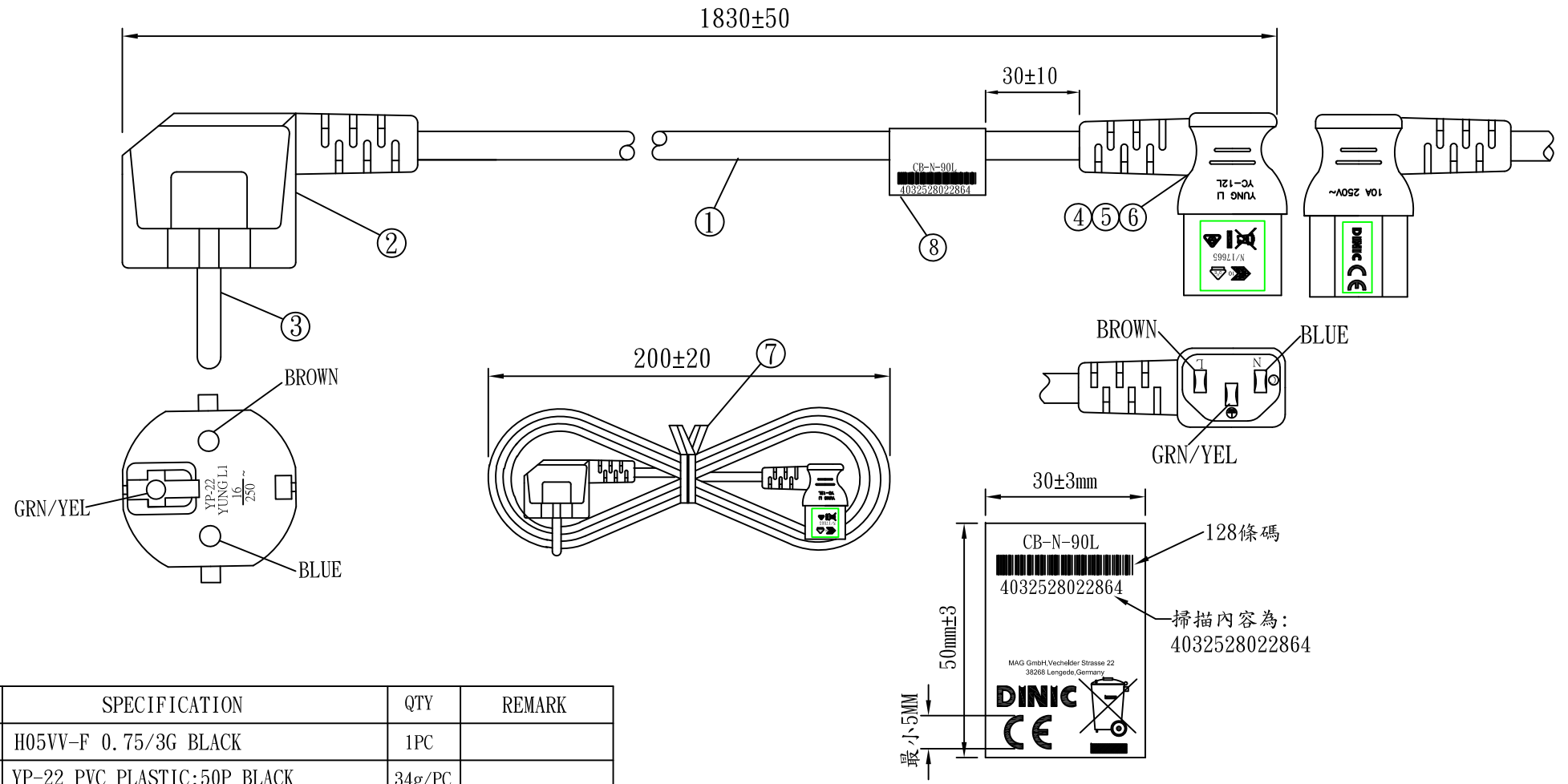

NO.	SPECIFICATION	QTY	REMARK
1	H05VV-F 0.75/3G BLACK	1PC	
2	YP-22 PVC PLASTIC:50P BLACK	34g/PC	
3	3Pin Euro plug inner model:98651 Black	1PC	
4	TER:97740	3PCS	
5	YC-12L-1 INNER BODY	1PC	
6	YC-12L-1 PVC PLASTIC:50P BLACK	18g/PC	
7	MINI TIE BLACK	1PC	
8	LABEL:50*30mm 128Code	1PC	

Tolerance >0±0.30 >1.0±0.50 >10.0±1.0 >20.0±2.0 Angle: ±1°	Approved		Date		YUNG LI CO., LTD.			
	Checked		Date					
	Drawn	SUKI	Date	24.03.21	Customer	MAG		
	Cat. No.	YP-22/YC-12L-1			P/N.	CB-N-90L		
	Drawing No.	CY-V0076-01	Rev.	B	Material	P.V.C	Unit	mm
				Scale				



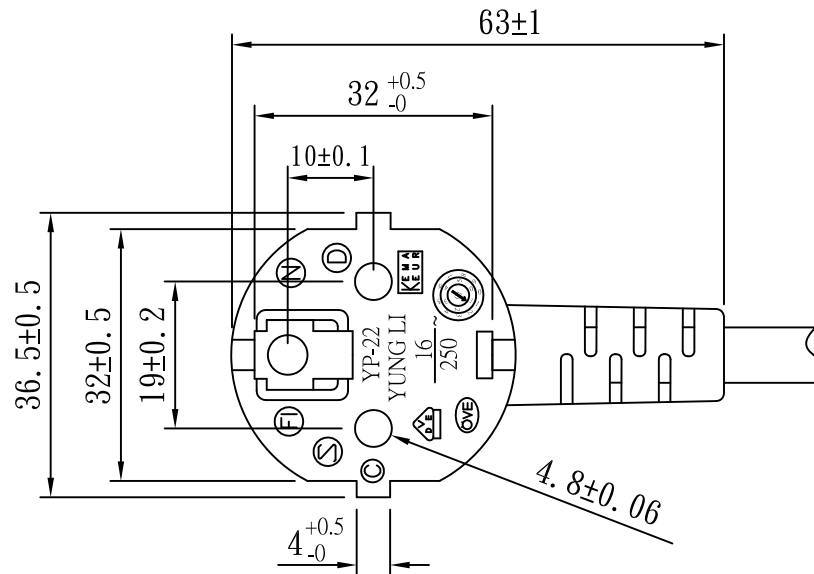
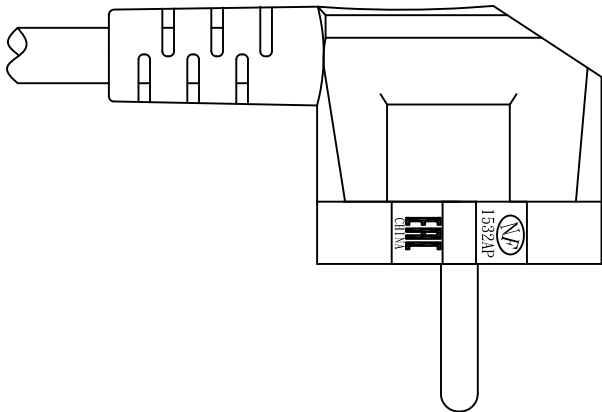
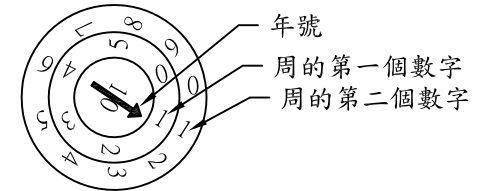
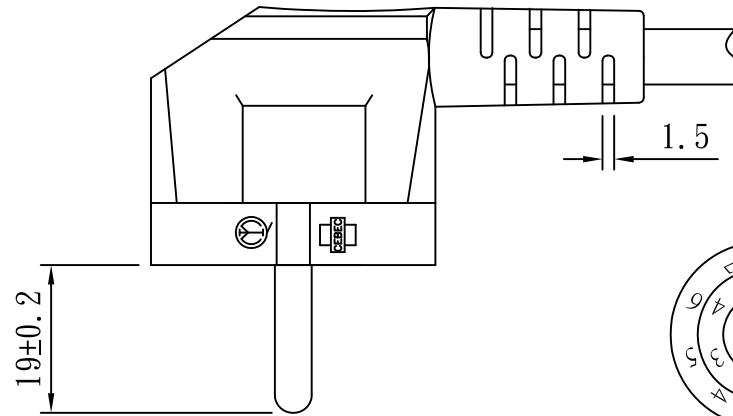
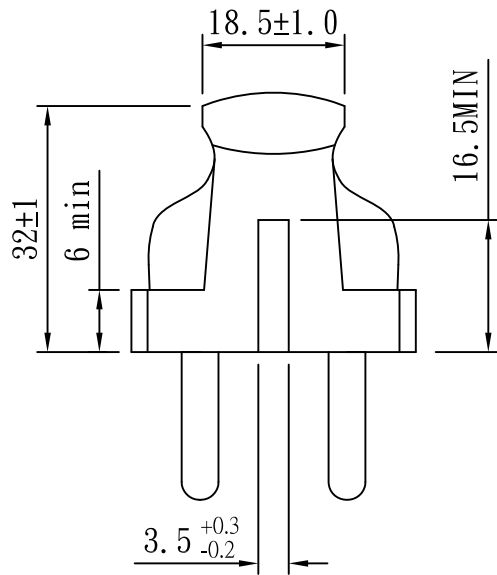

1532AP





TOLERANCE >0±0.30 >1.0±0.50 >10.0±1.0 >20.0±2.0 Angle: ±1°	APPROVED		DATE		YUNG LI CO., LTD.			
	CHECKED		DATE					
	DRAWN		DATE					
	TYPE	YP-22			P/N			
	DRAWING NO				MATERIAL	P.V.C	UNIT	mm
					SCALE	1:1		

IEC 60320 C13

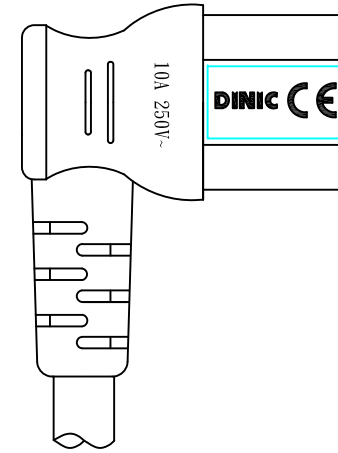
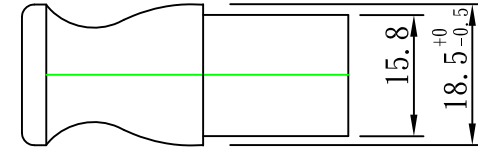
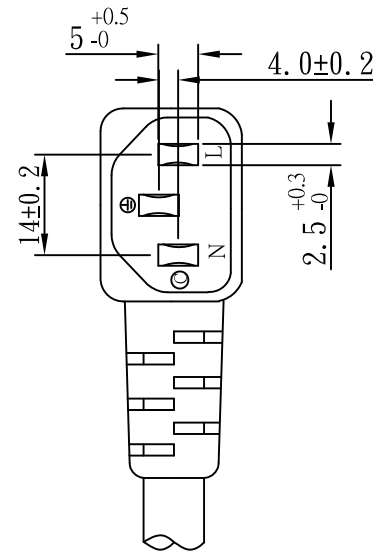
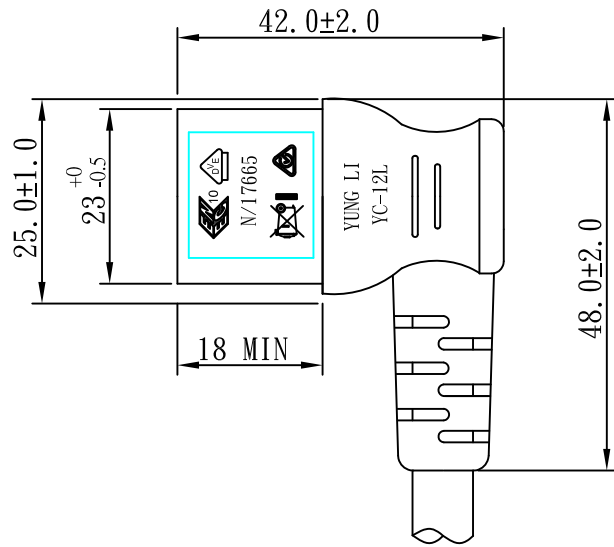
CE    N/17665



TOLERANCE >0±0.30 >1.0±0.50 >10.0±1.0 >20.0±2.0 Angle: ±1°	APPROVED		DATE		YUNG LI CO., LTD			
	CHECKED		DATE					
	DRAWN		DATE		CUSTOMER			
	TYPE	YC-12L			P/N			
	DRAWING NO.		REV	B	MATERIAL	P. V. C	UNIT	mm
				SCALE	1:1			

# YUNG LI CO., LTD









## SPECIFICATION

Yung Li	Style	PVC FLEXIBLE CORDS	Document No
2019.04.23			
Edition	Size	<b>H05VV-F 3G 0.75mm<sup>2</sup></b>	Page
A			1/2

1. Standard: IEC 227 IEC228  
 2. Construction & Dimension

	Item	Specification
Conductor	Size	3G 0.75mm <sup>2</sup>
	Material	Annealed Bare Copper
	Construction	24/ § 0.2±0.008
Insulation	Material	PVC
	Minimum Average Thickness	0.60mm
	Minimum Thickness at any point	0.44mm
	Diameter	2.35 ± 0.10
	Identification	Blue,Brown,Green/Yellow
Core Assembly	Core Twist	3-Core
	Filler	NA
	Assembly Pair	NA
Taping	Mylar Foil	NA
Shielded	A1-Mylar Foil	NA
Drain	Material	NA
	Construction	NA
Jacket	Material	PVC
	Minimum Average Thickness	0.8mm
	Minimum Thickness at any point	0.58mm
	Overall Diameter(Approx)	6.7 ± 0.2
	Color	Any Color

### Marking:

Yung Li Co., Ltd. H05VV-F 3G 0.75mm<sup>2</sup> <VDE> NF-USE 1347  KEMA-KEUR  CEBEC <ÖVE>  
     IEMMEQU SAA-190646-EA  A004049 60227 IEC 53(RVV) 300/500V  SU01027-4002

# YUNG LI CO., LTD

## SPECIFICATION

Yung Li	Style	PVC FLEXIBLE CORDS	Document No
2019.04.23			
Edition	Size	<b>H05VV-F 3G 0.75mm<sup>2</sup></b>	Page
A			2/2

### 4. Electrical & Physical Properties

Item	Specification		
Rating Voltage	70°C 300/500V		
Conductor resistance(AT 20°C)	26.0Ω/Km MAX		
Insulation Resistance(AT 70°C)	0.011MΩ/Km Min		
Dielectric Strength	AC 2.0 KV / 15 min No Break		
Spark Test	6.0KV		
Insulation	Unaged	Tensile Strength	1.02 kgf/mm <sup>2</sup> min
		Elongation	150% Min
	Aged	Tensile Strength	80~120% (80°C x168hrs)
		Elongation	80~120% (80°C x168hrs)
	Loss of mass Test		2.0mg/cm <sup>2</sup> (max)
	Jacket	Unaged	Tensile Strength
Elongation			150% Min
Aged		Tensile Strength	80~120% (80°C x168hrs)
		Elongation	80~120% (80°C x168hrs)
Loss of mass Test		2.0mg/cm <sup>2</sup> (max)	
Deformation Test		70±2°C X 4hr ≤ 50%	
Cold Bend Test		-15°C x 1hr No Crack	
Heat Shock Test		150±2°C x 1hr No Crack	

### Graph:

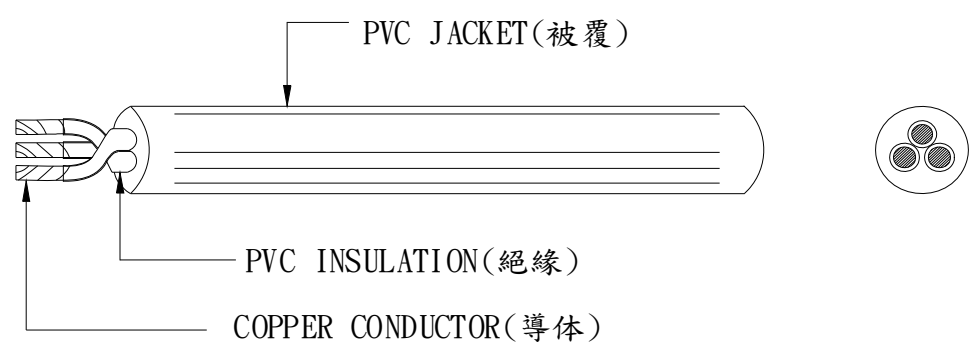

## ZEICHENGENEHMIGUNG MARKS APPROVAL

Yung-Li Co. Ltd.  
DaPu Industrial Zone, GangZi  
ChangPing Town  
523571 DongGuan City  
Guangdong  
China

ist berechtigt, für ihr Produkt /  
*is authorized to use for their product*

**Stecker mit Schutzkontakt, nicht wiederanschließbar, umspritzt**  
***Plug, with earthing contact, non-rewirable, moulded***

die hier abgebildeten markenrechtlich geschützten Zeichen  
für die ab Blatt 2 aufgeführten Typen zu benutzen /  
*the legally protected Marks as shown below for the types referred to on page 2 ff.*



Geprüft und zertifiziert nach /  
*Tested and certified according to*

DIN VDE 0620-2-1 (VDE 0620-2-1):2016-01  
DIN VDE 0620-2-1/A1 (VDE 0620-2-1/A1):2017-09

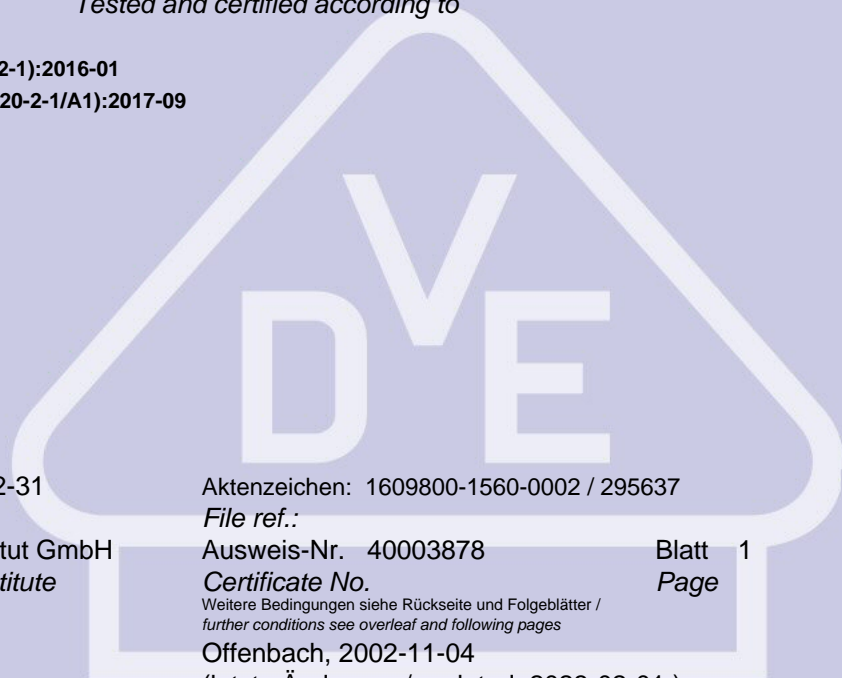

Befristet zum / *valid until:* 2025-12-31

VDE Prüf- und Zertifizierungsinstitut GmbH  
*VDE Testing and Certification Institute*  
Zertifizierungsstelle / *Certification*

M. Tasotti

Aktenzeichen: 1609800-1560-0002 / 295637

*File ref.:*

Ausweis-Nr. 40003878

Blatt 1

*Certificate No.*

Page

Weitere Bedingungen siehe Rückseite und Folgeblätter /  
*further conditions see overleaf and following pages*

Offenbach, 2002-11-04

(letzte Änderung / updated 2023-02-01 )

VDE Zertifikate sind nur gültig bei Veröffentlichung unter:  
*VDE certificates are valid only when published on:*

<http://www.vde.com/zertifikat>  
<http://www.vde.com/certificate>

Name und Sitz des Genehmigungs-Inhabers / *Name and registered seat of the Certificate holder*

Yung-Li Co. Ltd., DaPu Industrial Zone, GangZi, ChangPing Town, 523571 DONGGUAN CITY, Guangdong, CHINA

Aktenzeichen / *File ref.*

1609800-1560-0002 / 295637 / TL3 / SHA

letzte Änderung / *updated*

2023-02-01

Datum / *Date*

2002-11-04

Dieses Blatt gilt nur in Verbindung mit Blatt 1 des Zeichengenehmigungsausweises Nr. 40003878.

*This supplement is only valid in conjunction with page 1 of the Certificate No. 40003878.*

## **Stecker mit Schutzkontakt, nicht wiederanschließbar, umspritzt** **Plug, with earthing contact, non-rewirable, moulded**

Typ(en) / *Type(s)*

### **YP-22**

Bemessungsspannung  
*Rated voltage*

AC 250 V

Bemessungsstrom  
*Rated current*

16 A

Polzahl  
*Number of poles*

2-polig mit zwei Schutzkontaktsystemen  
*2-pole with two earthing contact systems*

Bauart  
*Kind of construction*

DIN 49441-R2

Schutzart  
*Degree of protection*

IP 20

Produktinformation

siehe Anlagen Nr.: 700, 701, 800, 801, 850 und 900  
vom 2023-02-01

*Product information*

*see Appendix No.: 700, 701, 800, 801, 850 and 900  
dated 2023-02-01*



# VDE Prüf- und Zertifizierungsinstitut Zeichengenehmigung

Ausweis-Nr. / Beiblatt /  
Certificate No. Supplement  
40003878

Name und Sitz des Genehmigungs-Inhabers / *Name and registered seat of the Certificate holder*

Yung-Li Co. Ltd., DaPu Industrial Zone, GangZi, ChangPing Town, 523571 DONGGUAN CITY, Guangdong, CHINA

Aktenzeichen / *File ref.*

1609800-1560-0002 / 295637 / TL3 / SHA

letzte Änderung / *updated*

2023-02-01

Datum / *Date*

2002-11-04

Dieses Beiblatt ist Bestandteil des Zeichengenehmigungsausweises Nr. 40003878.

*This supplement is part of the Certificate No. 40003878.*

## **Stecker mit Schutzkontakt, nicht wiederanschließbar, umspritzt** **Plug, with earthing contact, non-rewirable, moulded**

**Fertigungsstätte(n)**

**Place(s) of manufacture**

Referenz/*Reference*

**30008928**

Yung-Li Co. Ltd.

DaPu Industrial Zone, GangZi

ChangPing Town

523571 DONGGUAN CITY

Guangdong

CHINA

Name und Sitz des Genehmigungs-Inhabers / Name and registered seat of the Certificate holder

Yung-Li Co. Ltd., DaPu Industrial Zone, GangZi, ChangPing Town, 523571 DONGGUAN CITY, Guangdong, CHINA

Aktenzeichen / File ref.

1609800-1560-0002 / 295637 / TL3 / SHA

letzte Änderung / updated

2023-02-01

Datum / Date

2002-11-04

Dieses Blatt gilt nur in Verbindung mit Blatt 1 des Zeichengenehmigungsausweises Nr. 40003878.

*This supplement is only valid in conjunction with page 1 of the Certificate No. 40003878.*

## **Genehmigung zum Benutzen des auf Seite 1 abgebildeten markenrechtlich geschützten Zeichens des VDE:**

Grundlage für die Benutzung sind die Allgemeinen Geschäftsbedingungen (AGB) der VDE Prüf- und Zertifizierungsinstitut GmbH ([www.vde.com\AGB-Institut](http://www.vde.com\AGB-Institut)). Das Recht zur Benutzung erstreckt sich nur auf die bezeichnete Firma mit den genannten Fertigungsstätten und die oben aufgeführten Produkte mit den zugeordneten Bezeichnungen. Die Fertigungsstätte muss so eingerichtet sein, dass eine gleichmäßige Herstellung der geprüften und zertifizierten Ausführung gewährleistet ist.

Die Genehmigung ist so lange gültig wie die VDE-Bestimmungen gelten, die der Zertifizierung zugrunde gelegen haben, sofern sie nicht auf Grund anderer Bedingungen aus der VDE Prüf- und Zertifizierungsordnung (PM102) zurückgezogen werden muss.

Der Gültigkeitszeitraum einer VDE-GS-Zeichengenehmigung kann auf Antrag verlängert werden. Bei gesetzlichen und / oder normativen Änderungen kann die VDE-GS-Zeichengenehmigung ihre Gültigkeit zu einem früheren als dem angegebenen Datum verlieren.

Produkte, die das Biozid Dimethylfumarat (DMF) enthalten, dürfen gemäß der Kommissionsentscheidung 2009/251/EG nicht mehr in den Verkehr gebracht oder auf dem Markt bereitgestellt werden.

Der VDE-Zeichengenehmigungsausweis wird ausschließlich auf der ersten Seite unterzeichnet.

### **Approval to use the legally protected Mark of the VDE as shown on the first page:**

*Basis for the use are the general terms and conditions of the VDE Testing and Certification Institute ([www.vde.com\terms-institute](http://www.vde.com\terms-institute)). The right to use the mark is granted only to the mentioned company with the named places of manufacture and the listed products with the related type references. The place of manufacture shall be equipped in a way that a constant manufacturing of the certified construction is assured.*

*The approval is valid as long as the VDE specifications are in force, on which the certification is based on, unless it is withdrawn according to the VDE Testing and Certification Procedure (PM102E).*

*The validity period of a VDE-GS-Mark Approval may be prolonged on request. In case of changes in legal and / or normative requirements, the validity period of a VDE-GS-Mark Approval may be shortened.*

*Products containing the biocide dimethylfumarate (DMF) may not be marketed or made available on the EC market according to the Commission Decision 2009/251/EC.*

*The approval is solely signed on the first page.*



# ÖVE-CERTIFICATE

including the entitlement to use the Austrian Safety Mark



Certificate No.: **21721-006-08**

Valid from: 2023 02 17  
until: 2025 02 17

The Austrian Electrotechnical Association (OVE) hereby grants the right to the company mentioned below to label the listed products with the Austrian Safety Mark.

Company: **Yung Li Co. Ltd.**  
Da Pu Industrial Zone, Gang Zi, Chang Ping Town  
523571 Dong Guan City, Guang Dong Province  
China

Product: **Non rewirable two pole plug with dual earthing system**

The products submitted by the applicant were type tested in accordance with the requirements of the technical standards and specifications listed in this certificate. OVE certifies the conformity of the listed products and those products manufactured strictly identical to the submitted ones (EN ISO/IEC 17067, Conformity Assessment Scheme Type 5).

The manufacturing process and the products are subject to ongoing surveillance based on harmonized European procedures. This certificate has been issued under the presumption and conditional on the fact that the applicant holds all necessary legal rights with regard to the product, presented for the testing and certification.

Results of testing are shown in file No(s): **1740-1182/03**

**Österreichischer Verband für Elektrotechnik**  
Head of OVE Certification

*T. Neumayer*  
Digitally signed by T. Neumayer  
Email=t.neumayer@ove.at

Dipl.-Ing. T. Neumayer

Wien, 2023 01 10



## OVE Certification

Accredited by the Federal Ministry for Digital and Economic Affairs as Certification Body for products within the scope as given in the official decree and published under <https://akkreditierung-austria.gv.at>.



**Manufacturer:**

Yung Li Co. Ltd.  
Da Pu Industrial Zone, Gang Zi, Chang Ping Town  
523571 Dong Guan City, Guang Dong Province  
China

**Factory location(s):**

Yung Li Co. Ltd.  
Da Pu Industrial Zone, Gang Zi, Chang Ping Town  
523571 Dong Guan City, Guang Dong Province  
China

**Tested and certified according to:**

ÖVE/ÖNORM IEC 60884-1:2005-09-01

**Product: Non rewirable two pole plug with dual earthing system**

**Type designation:**

*Rating:*

**Trademark:**

**YP-22**

Rated voltage: AC 250 V

Rated current: 16 A

H03VV-F 3 G 0,75

YUNG LI

**YP-22**

Rated voltage: AC 250 V

Rated current: 16 A

H05VV-F 3 G 0,75

YUNG LI

**YP-22**

Rated voltage: AC 250 V

Rated current: 16 A

H05VV-F 3 G 1

YUNG LI

**YP-22**

Rated voltage: AC 250 V

Rated current: 16 A

H05VV-F 3 G 1,5

YUNG LI

**OVE Certification**

Accredited by the Federal Ministry for Digital and Economic Affairs as Certification Body for products within the scope as given in the official decree and published under <https://akkreditierung-austria.gv.at>.



**L C I E**

Accréditation  
N°5-0014  
Portée  
disponible sur  
www.cofrac.fr



# LICENCE



LCIE N° 621358

**Délivrée à:**  
*Delivered to:* **YUNG LI Co., Ltd**  
1F, No 10, Lane 235, Pao-Chiang Road, Hsin-Tien - TAIPEI - TAIWAN

**Site de fabrication:**  
*Factory:* **YUNG LI Co., Ltd. (1532AP)**  
Da Pu Industrial Zone, Gang Zi, Chang Ping Town - Dong Guan City - GUANG DONG PROVINCE 523571 - CHINE

**Produit:**  
*Product:* **Fiche de prise de courant**  
*Plug*

**Marque commerciale (s'il y a lieu):**  
*Trade mark (if any):* **YUNG-LI**

**Modèle, type, référence:**  
*Model, type, reference:* **YP-22**

**Caractéristiques nominales et principales:**  
*Rating and principal characteristics:* **16A 250V~, 2P avec contact de terre/2P with dual earthing contact voir annexe/see annex**

**Informations complémentaires:**  
*Additional informations:* **Mise à jour suite à évolution de la norme**  
*update further to the evolution of the standard*

**Le produit est conforme à:**  
*The product is in conformity with:* **NF C 61-314:2008 +A1:2010**

**Documents pris en compte:**  
*Relevant documents:* **Rapport d'essai/test report n° BVCB11DE1038ACSP, certificat d'essai OC/CB test certificate n° DE1-42031 / TR 1609800-1560-0002/122934**

**Annule et remplace (s'il y a lieu):**  
*Cancel and replaces (if necessary):* **Licence n°555296 du 2007-02-08**

En vertu de la présente décision notifiée par le LCIE France organisme mandaté, AFNOR Certification accorde le droit d'usage de la Marque NF à la société qui en est titulaire pour les produits visés ci-dessus, dans les conditions définies par les règles générales de la Marque NF et par les règles de certification NF, pour autant que les contrôles réguliers de la fabrication et les vérifications par tierce partie soient satisfaisants.

Fontenay-aux-Roses, 2012-01-11

**Date limite de validité :**

*Limit expired date :*

La validité de la présente licence cesse dès l'annulation de l'une des normes sur laquelle elle est fondée.  
*The present licence is valid until the cancellation of one of the standards on which it is based.*

On the strength of the present decision notified by LCIE France mandated certification body, AFNOR Certification grants the right to use the NF Mark to the licence holder for the above mentioned products, within the frame of the general rules of the NF Mark and of the NF certification rules, as far as the regular checking and third party verifications of the production are satisfactory.

**Michel BRENON**

Directeur de la Certification  
*Certification Manager*

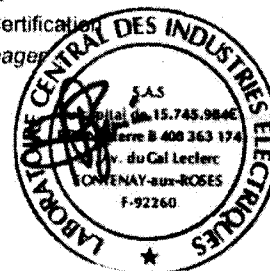

PID:  
02113100  
CID:  
C.1996.5269

## Certificato di approvazione *Approval certificate*

**IMQ, ente di certificazione accreditato, autorizza la ditta**      *IMQ, accredited certification body, grants to*

**YUNG LI CO., LTD.  
DA PU IND. ZONE, GangZi, CHANG PING TOWN  
DONG GUAN CITY, GUANG DONG PROV.  
CN - China**

**all'uso del marchio**

*the licence to use the mark*

**IMQ**

Il presente certificato è soggetto alle condizioni previste nel "Regolamento IMQ - Certificazione prodotto" ed è relativo ai prodotti descritti nell'Allegato al presente certificato.



**per i seguenti prodotti**

*for the following products*

**Spine indissolubilmente  
collegate al cavo  
( Rif. di tipo YP-22 )**

*Non-rewirable plugs  
( Type ref. YP-22 )*

*This certificate is subjected to the conditions foreseen by "IMQ Rules - Product Certification" and is relevant to the products listed in the annex to this certificate.*

Emesso il | Issued on      **2003-04-17**  
Aggiornato il | Updated on      **2011-09-21**  
Sostituisce | Replaces      **2008-06-17**

  
**IMQ S.p.A.**

**Allegato - Certificato di approvazione**  
**Annex - Approval certificate**

*Emesso il / Issued on* 2003-04-17  
*Aggiornato il / Updated on* 2011-09-21  
*Sostituisce / Replaces* 2008-06-17

**Prodotto | Product**

***Spine indissolubilmente collegate al cavo***  
***Non-rewirable plugs***

**Concessionario | Licence Holder**

**YUNG LI CO., LTD.**  
**DA PU IND. ZONE, GangZi, CHANG PING TOWN**  
**DONG GUAN CITY, GUANG DONG PROV.**  
**CN - China**

**Marchio | Mark**



IMQ

**Costruito a | Manufactured at**

PI.B000M3 C01175219

DONG GUAN CITY, GUANG DONG PROV.

China

*Copia del presente certificato deve essere conservata presso i luoghi di produzione sopra elencati.*

*Copy of this certificate must be available at the manufacturing places listed above*

**Norme**

CEI 23-50 - II Ed. 2007 + V1:2008

**Standards**

CEI 23-50 - II Ed. 2007 + V1:2008

**Rapporti | Test Reports**

26LL00072

**Caratteristiche tecniche | Technical characteristics**

*Designazione | Type designation* **2P+T+T S31 / 2P+E+E S31**  
*Tensione nominale | Rated voltage* **250 V**  
*Corrente nominale | Rated current* **16 A**  
*Grado di protezione | Degree of protection (IP)* **IP20**  
*Tipo di morsetti | Type of terminals* **morsetti aggraffati / crimped connections**  
*Materiale della custodia | Material of the cover* **termoplastico / thermoplastic**  
*Uscita cavo | Cable exit* **a squadra / angled**

**Articoli (con dettagli) | Articles (with details)**

AR.D0022W

*Marca | Trade mark* **YUNG-LI**  
*Riferimento di tipo | Type reference* **YP-22**  
*Tipo di cavo | Type of cable* **H03VV-F**  
*Sezione nominale | Section areas* **3G0,75 mm<sup>2</sup>**

AR.D0022X

*Marca | Trade mark* **YUNG-LI**  
*Riferimento di tipo | Type reference* **YP-22**  
*Tipo di cavo | Type of cable* **H05VV-F**  
*Sezione nominale | Section areas* **3G0,75 mm<sup>2</sup>**

AR.D0022Y

*Marca | Trade mark* **YUNG-LI**  
*Riferimento di tipo | Type reference* **YP-22**  
*Tipo di cavo | Type of cable* **H05VV-F**  
*Sezione nominale | Section areas* **3G1 mm<sup>2</sup>**

AR.D0022Z

Marca / Trade mark **YUNG-LI**  
Riferimento di tipo / Type reference **YP-22**  
Tipo di cavo / Type of cable **H05VV-F**  
Sezione nominale / Section areas **3G1,5 mm<sup>2</sup>**

## Ulteriori informazioni | Additional Information

La spina rif. di tipo YP-22 è prodotta col seguente inserto:  
marca: GEM ; art.: P98651.

The non-rewirable plug type ref. YP-23 is manufactured with the following insert:  
trade mark: GEM; art.: P98651.

## Componenti | Component List

### Rif. di tipo/Type ref. YP-22

Tipo / Type	(*)	Costruttore / Manufacturer	Riferimento / Type Ref.	Dati / Data	Norme / Standard (*)	Marchi / Marks
Cavo / Cable	2/4	YUNG LI	YUNG LI	H03VV-F	-	IMQ
Cavo / Cable	2/4	YUNG LI	YUNG LI	H05VV-F	-	IMQ

Emesso il / Issued on **2008-06-17**      Data di aggiornamento / Updated on **2011-09-21**      Sostituisce / Replaces **2008-06-17**

Ciascun componente è contraddistinto da un numero avente il seguente significato:

- 1 - Componente marchiato e sostituibile con altro pure marchiato con caratteristiche equivalenti
- 2 - Componente sostituibile solo previa autorizzazione dell'IMQ
- 3 - Componente (integrato nell'apparecchio utilizzatore) provato congiuntamente all'apparecchio utilizzatore
- 4 - Componente in alternativa
- 5 - Componente per uso opzionale
- 6 - Componente da abbinare

Each component is signed by a number having the following meaning:

- 1 - Approved component replaceable with another one also approved with equivalent characteristics
- 2 - Component replaceable with IMQ authorization only
- 3 - Integrated component tested together with appliances
- 4 - Alternative component
- 5 - Component for optional use
- 6 - Component to be matched

(\*) Queste colonne sono compilate a cura di IMQ / These columns are filled in by IMQ

## Diritti di concessione | Annual Fees

SN.D000DL      BTL.021100.DA19      Diritti modelli IMQ - 0211 - Prese, spine e connettori di uso domestico | IMQ models - 0211 - Plugs and appliance couplers for domestic purposes

1



**IMQ S.p.A.**



# DEMKO CERTIFICATE

**Certificate No.** D-06167  
**Page** 1/3  
**Date of Issue** 2017-10-24

**Certificate Holder** Yung Li Co Ltd  
7F-12 No 99 Sec 1 Xintai 5th Rd  
Xizhi District  
New Taipei, 22175 Taiwan

**Manufacturer** Yung Li Co Ltd  
7F-12 No 99 Sec 1 Xintai 5th Rd  
Xizhi District  
New Taipei, 22175 Taiwan

**Production site** Yung Li Co Ltd  
Da Pu Industrial Zone  
Gangzi Chang Ping Town  
Dongguan, 523571 Guangdong China

**Certified Product Model** Non-rewirable, Two-pole plug with dual earthing contacts  
YP-22  
**Trademark** YUNG LI

**Rated Voltage / Frequency** 250 V ~  
**Rated Current / Power** 16 A  
**Insulation Class** -  
**Degree of protection (IP)** 20  
**Tested acc. to** DS 60884-2-D1:2017  
**Test Report No.** 4788152169 issued on 2017-10-24  
**Additional** This certificate replaces the earlier issued certificate No.D-05356  
**Expire date** 2026-06-12

**Certification Manager**  
Jan-Erik Storgaard

This is to certify that representative sample(s) of the Product described herein ("Certified Product") have been investigated and found in compliance with the Standard(s) indicated on this Certificate, in accordance with the D Mark Requirements. The Designated Certificate holder is entitled to use the d or for cables <DEMKO> for the Certified Product manufactured at the production site(s) identified above, in accordance with the D Mark Service Agreement, including without limitation the D Mark Testing and Certification Services Service Terms. Only those Products bearing the D Mark should be considered as being covered by UL's D Mark Service. This Certificate shall remain valid through the expiration date, unless terminated earlier in accordance with the Service Agreement including without limitation if the Standard identified on this Certificate is amended or withdrawn prior the expiration date.

**Certification Body**

UL International Demko A/S, Borupvang 5A, DK-2750  
Ballerup, Denmark, Tel. +45 44 85 65 65, info.dk@ul.com  
www.ul-europe.com



# Appendix DEMKO CERTIFICATE

**Certificate No.** D-06167  
**Page** 2/3  
**Date of Issue** 2017-10-24

External Certification Information:  
FI 9308, issued on 2016-06-13 by SGS Fimko Ltd

Additional Information:  
For class I equipment  
Standard Sheet:  
C4 (DS 60884-2-D1)  
VII (CEE 7)

Flexible Cord:  
YP-22 with H03VV-F 3G0.75 mm<sup>2</sup>  
YP-22 with H05VV-F 3G0.75-1.0-1.5 mm<sup>2</sup>  
YP-22 with H03V2V2-F 3G0.75 mm<sup>2</sup>  
YP-22 with H05V2V2-F 3G0.75-1.0-1.5 mm<sup>2</sup>  
YP-22 with H05RN-F 3G0.75-1.0 mm<sup>2</sup>

---

**Certification Body**

UL International Demko A/S, Borupvang 5A, DK-2750  
Ballerup, Denmark, Tel. +45 44 85 65 65, info.dk@ul.com  
[www.ul-europe.com](http://www.ul-europe.com)



# Appendix DEMKO CERTIFICATE

Certificate No. D-06167  
Page 3/3  
Date of Issue 2017-10-24

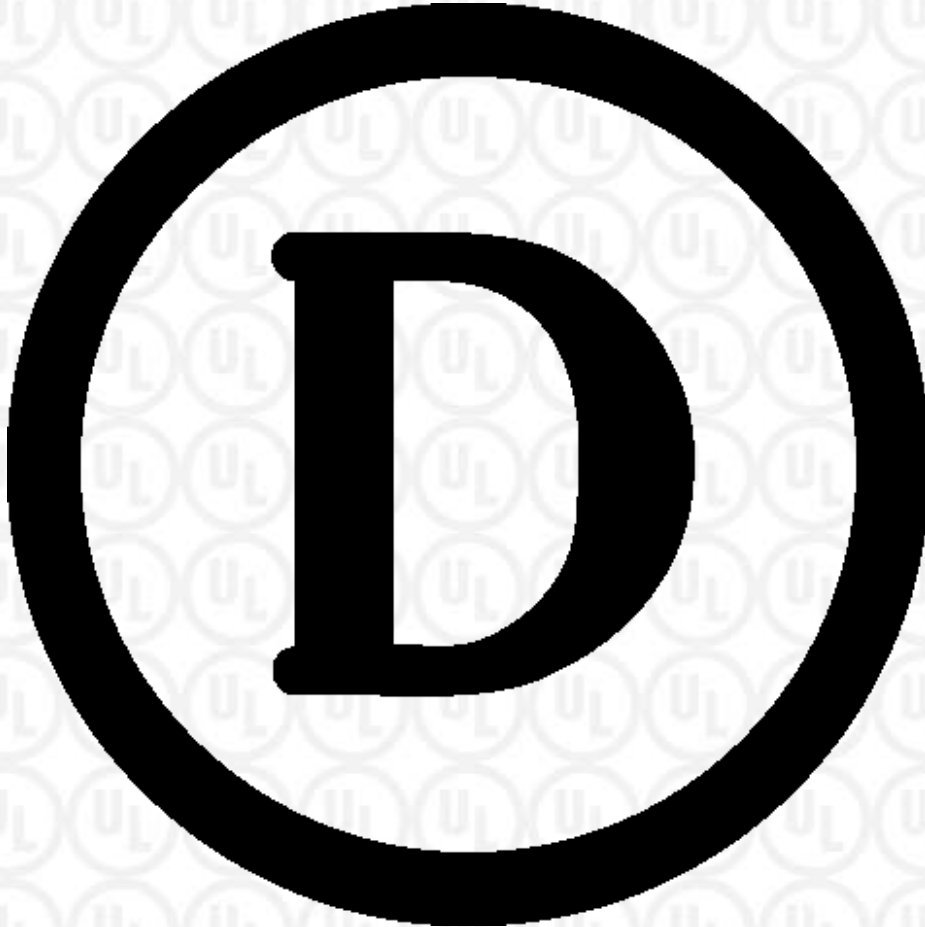

---

Certification Body

UL International Demko A/S, Borupvang 5A, DK-2750  
Ballerup, Denmark, Tel. +45 44 85 65 65, info.dk@ul.com  
[www.ul-europe.com](http://www.ul-europe.com)





# CERTIFICATE

No. P22226558



**Applicant** Yung Li Co., Ltd. China  
Da Pu Industrial Zone, Chang Ping Town, Dong Guan City, 523571 Guangdong  
China

**Manufacturer** Yung Li Co., Ltd. China  
Da Pu Industrial Zone, Chang Ping Town, Dong Guan City, 523571 Guangdong  
China

**Factory** Yung Li Co., Ltd. China  
Da Pu Industrial Zone, Chang Ping Town, Dong Guan City, 523571 Guangdong  
China

**Project Number** PRJ0019918

**Product** Plugs

**Model/Type Ref.** YP-22

**Ratings** 16A 250V~

**Trademark** YUNG LI

**Principal Characteristics** Non-rewirable two-pole plug with dual earthing contacts. Standard Sheet VII of  
NEK 502, Thermoplastic, with cable H03VV-F 3G0.75mm<sup>2</sup>, IP20.

**A sample of the product was tested and found to be in conformity with** Safety IEC 60884-1:2002, IEC 60884-1:2002/AMD1:2006, IEC 60884-1:2002/AMD2:2013  
NEK 502:2016/AMD1:2022

**Validity** This certificate documents conformity with the standards shown, and also applies  
as license for use of Nemko's name and certification mark. The certificate and  
license is valid as long as the applicable conditions are complied with, and  
provided that any changes to the product are notified to Nemko for acceptance  
prior to implementation.

New standards or amendments to the standards may imply that the product design  
must be updated and/or that re-testing and re-certification is necessary.

## Additional Information

**Additional model(s)** (1) See page 2

**Signature** Name: Juan Saussey

Certification Department

**Date of issue** 23 / 11 / 2022

Working for a more sustainable future- Please do not print



[www.nemko.com](http://www.nemko.com)

Page 1 of 3

**Product** Plugs  
**Variant No.** 1  
**Model/Type Ref.** YP-22  
**Ratings** 16A 250V~  
**Trademark (if different from page 1)** YUNG LI  
**Principal Characteristics** Non-rewirable two-pole plug with dual earthing contacts. Standard Sheet VII of NEK 502, Thermoplastic, with cable H05VV-F 3G0.75-1-1.5mm<sup>2</sup>, IP20.

**Product** Plugs  
**Variant No.** 2  
**Model/Type Ref.** YP-22  
**Ratings** 16A 250V~  
**Trademark (if different from page 1)** YUNG LI  
**Principal Characteristics** Non-rewirable two-pole plug with dual earthing contacts. Standard Sheet VII of NEK 502, Thermoplastic, with cable H03V2V2-F 3G0.75mm<sup>2</sup>, IP20.

**Product** Plugs  
**Variant No.** 3  
**Model/Type Ref.** YP-22  
**Ratings** 16A 250V~  
**Trademark (if different from page 1)** YUNG LI  
**Principal Characteristics** Non-rewirable two-pole plug with dual earthing contacts. Standard Sheet VII of NEK 502, Thermoplastic, with cable H05V2V2-F 3G0.75-1-1.5mm<sup>2</sup>, IP20.

**Signature**

Name: Juan Saussey  
Certification Department  
23 / 11 / 2022

**Date of issue**



[www.nemko.com](http://www.nemko.com)

Page 2 of 3



# CERTIFICATE

No. P22226558



<b>Product</b>	Plugs
<b>Variant No.</b>	4
<b>Model/Type Ref.</b>	YP-22
<b>Ratings</b>	16A 250V~
<b>Trademark (if different from page 1)</b>	YUNG LI
<b>Principal Characteristics</b>	Non-rewirable two-pole plug with dual earthing contacts. Standard Sheet VII of NEK 502, Thermoplastic, with cable H05RN-F 3G0.75-1.0mm <sup>2</sup> , IP20.

Nemko Group AS  
Philip Pedersens vei 11  
1366 Lysaker, Norway  
TEL +47 22 96 03 30  
info@nemko.com  
ENTERPRISE NUMBER  
NO974404532

**Signature**

**Date of issue**

Name: Juan Saussey  
Certification Department  
23 / 11 / 2022



[www.nemko.com](http://www.nemko.com)

Page 3 of 3

Working for a more sustainable future- Please do not print



# CERTIFICATE

## FOR EUROPEAN PRODUCT SAFETY

Reference No. SE-S-2100166R1

### Plug, non rewirable

**Type designation:** YP-22

**Certificate holder:** YUNG LI CO. LTD.  
DA PU Industrial Zone  
Gangzi Chang Ping Town  
523571 Guangdong  
CHINA

**The product complies with the standard(s):** IEC 60884-1:2002+A1+A2  
SS 428 08 34:2013+R1+T1  
SFS 5610:2015+A11

**Date of expiry:** 02 February, 2026

Additional information in Appendix

**Certification Body:** Intertek Semko AB, Product Certification **Place:** Kista - Stockholm

**Signed:**  **Date:** 05 May, 2021

Leif Mattsson

## APPENDIX:

Reference No. SE-S-2100166R1

### Technical Data:

Type designation	YP-22
Rated voltage (V)	250V~
Rated current (A)	16A
IP-Class	IP20
Type of cord	H03V2V2-F 3G0,75mm2, H03VV-F 3G0,75mm2, H05V2V2-F 3G0,75-1,5mm2, H05VV-F 3G0,75-1,5mm2, H05RN-F 3G0,75-1,0mm2
Standard sheet	VII
Trademark	YUNG-LI
Test Report	2103009STO-001
Product information	Plug, non-rewirable for class I equipment, 2P+E with dual earthing contact. With angled cord entry.

### Manufacturing Sites:

YUNG LI CO. LTD.  
DA PU Industrial Zone  
Gangzi Chang Ping Town  
523571 Guangdong  
China

If the product is to be marketed in different European countries, it must be provided with a certified plug appropriate for each country.

The instruction for use shall be written in a language acceptable according to the national regulation in the country where the product is to be used.

This certificate is based on Ref. no. FI 9308 dated 13 June 2016, issued by SGS Fimko Ltd.

This certificate replaces previously issued S-certificate with ref. No. SE-S-2100166 dated 2 February 2021. A new certificate has been issued on account of adding the Finnish national standard.

### Certification Body:

Intertek Semko AB, Product Certification

**Place:** Kista - Stockholm

### Signed:



Leif Mattsson

**Date:** 05 May, 2021



# CERTIFICATE

Issued to:  
Applicant:  
**Yung Li Co., Ltd.**  
**Da Pu Industrial Zone, Chang Ping Town**  
**523571 Dongguan City, China**

Manufacturer/Licensee:  
**Yung Li Co., Ltd.**  
**Da Pu Industrial Zone, Chang Ping Town**  
**523571 Dongguan City, China**

Product : plug, (2-pole)  
Trade name : YUNG LI  
Type/model : YP-22

The product and any acceptable variation thereto is specified in the Annex to this certificate and the documents therein referred to.

DEKRA hereby declares that the above-mentioned product has been certified on the basis of:

- a type test according to the standard IEC 60884-1:2002 + A1:2006 and NEN 1020:1987 + A2:2004
- an inspection of the production location according to CENELEC Operational Document CIG 021
- a certification agreement with the number 2078870

DEKRA hereby grants the right to use the KEMA-KEUR certification mark.

The KEMA-KEUR certification mark may be applied to the product as specified in this certificate for the duration of the KEMA-KEUR certification agreement and under the conditions of the KEMA-KEUR certification agreement.

This certificate is issued on 16 November 2012 and expires upon withdrawal of one of the above mentioned standards.

Certificate number: 2158219.01

DEKRA Certification B.V.



drs. G.J. Zoetbrood  
Managing Director



H.R.M. Barends  
Certification Manager

© Integral publication of this certificate is allowed

All testing, inspection, auditing and certification activities of the former KEMA Quality are an integral part of the DEKRA Certification Group.

ACCREDITED BY  
THE DUTCH COUNCIL  
FOR ACCREDITATION



**SPECIFICATION OF THE CERTIFIED PRODUCT****Product data**

product	: plug, (2-pole)
trade name	: YUNG LI
type	: YP-22, YP-22
rated current	: 16 A
rated voltage	: 250 V~
earthing	: with dual earthing contacts
design	: non-rewirable, angled
standard sheet	: VII
description	: body of thermoplastic material as part of a complete or incomplete cord set for class I appliances
markings	: are shown on the body

**List of components**

Component	trade name	type/model	approval mark <sup>1)</sup>
insert	GEM Terminal Ind. Co., Ltd.	98651A-VDE	*

<sup>1)</sup> \* indicates a component tested as part of the appliance

**Product data - type YP-22**

applied flexible cords	: H05RR-F 3G1,5 mm <sup>2</sup> H07RN-F 3G1,0 and 3G1,5 mm <sup>2</sup>
certification mark	: complies with the specified requirements
cord termination	: crimped connection
design	: big cord guard

**Product data - type YP-22**

applied flexible cords	: H03VV-F 3G0,75 mm <sup>2</sup> H03V2V2-F 3G0,75 mm <sup>2</sup> H05VV-F 3G0,75, 3G1,0 and 3G1,5 mm <sup>2</sup> H05V2V2-F 3G0,75, 3G1,0 and 3G1,5 mm <sup>2</sup> H05RR-F 3G0,75 and 3G1,0 mm <sup>2</sup> H05RN-F 3G0,75 and 3G1,0 mm <sup>2</sup>
certification mark	: complies with the specified requirements
cord termination	: crimped connection
design	: small cord guard

**TESTS****Test requirements**

IEC 60884-1:2002 + A1:2006  
NEN 1020:1987 + A2:2004

**Test result**

The test results are laid down in DEKRA test file 2158219.01.

**Remarks**

This certificate replaces our certificate 2026550.01 dated 2003-01-20 and is partly based on VDE CB Test Certificate DE1-42031 dated 2009-10-12.

**Conclusion**

The examination proved that all test requirements were met.

Tested by : VDE

Checked by : M.A.R. Bollen

**Factory locations**

Yung Li Co., Ltd.

Da Pu Industrial Zone, Chang Ping Town  
523571 Dongguan City, China

# LICENCE

No. 18291 replaces No.12989

Issued to:

Applicant:

**Yung Li Co. Ltd.**

**1F, No.10, Lane 235,**

**Pao-Chiao Road**

**Hsin-Tien, New Taipei, Taiwan**

Licensee:

**Yung Li Co. Ltd.**

**1F, No.10, Lane 235,**

**Pao-Chiao Road**

**Hsin-Tien, New Taipei, Taiwan**



Product : plugs (2-pole) for household purposes

Trade name(s) : YUNG-LI

Type(s)/model(s) : YP-22

The product and any acceptable variation thereto is specified in the annex to this licence and the documents therein referred to.

SGS CEBEC hereby declares that the above-mentioned product has been certified on the basis of:

- a type test according to the standard specified in annex
- an inspection of the production location
- a certification agreement with the number 1031

SGS CEBEC hereby grants the right to use the CEBEC certification mark

The CEBEC certification mark may be applied to the product as specified in this licence for the duration of the CEBEC certification agreement and under the conditions of the CEBEC certification agreement.

This licence is issued on: 26/03/2013

ir. C. Lana,  
Certification Manager

© Only integral publication of this certificate, including the annex, is allowed

This certificate is only valid combined with the publication on the following web address: [www.sgs.com/ee](http://www.sgs.com/ee)

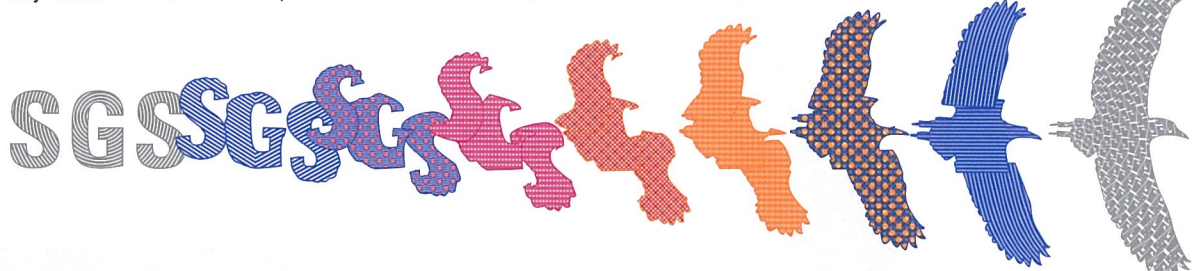

## SPECIFICATION OF THE CERTIFIED PRODUCT

### Product data

Product	:	plugs (2-pole) for household purposes
Trade name(s)	:	YUNG-LI
Type(s)/Model(s)	:	YP-22
rated current (In)	:	16 A
rated voltage (Un)	:	250 Vac
earthing	:	with dual earthing system
design	:	non-rewirable angled cable entry
class	:	for class I appliances
standard sheet	:	VII of CEE 7
applied flexible cord(s)	:	H03 VV-F 3G0.75 mm <sup>2</sup> H05 VV-F 3G0.75-1.5 mm <sup>2</sup> H03V2V2-F 3 G 0,75 mm <sup>2</sup> H05V2V2-F 3 G 0,75-1.5 mm <sup>2</sup>
description	:	body of thermoplastic material as part of an incomplete cord set for class I appliances
applied flexible cord(s) (cont'd)	:	H05RR-F 3 G 0,75-1,5 mm <sup>2</sup> H05RN-F 3 G 0,75-1.0 mm <sup>2</sup> H07RN-F 3 G 1,0-1,5 mm <sup>2</sup>
cord(s) termination	:	crimped connection
certification mark	:	complies with the requirements
markings	:	are shown on the body

### Additional information

Live part carriers: PBT, type 4115, black, Chang Chun Plastics.  
Moulding: PVC, type Flex 60 O, all colours, Pure Friend Business Enterprise Corp.  
Insert: GEM

## TESTS

### Test requirements

NBN C 61-112-1 based on IEC 60884-1:2002 + A1:2006

**Test results**

The test results are laid down in certification file ref.596812/01

**Remarks**

This certificate is based on certificate ref. CB DE1-42031 and test report(s) ref. 1609800-1560-0002/122934

**Conclusion**

The examination proved that all test requirements were met.

Checked by, project leader : Zanutto Luigi - 26/03/2013

Department Manager,  
Product Certification :

Certification Manager :

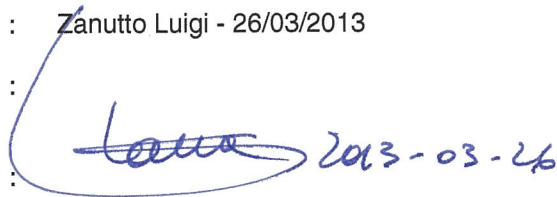
 2013-03-26

**FACTORY LOCATION(S)**

Yung Li Co., Ltd.  
Da Pu Industrial Zone, GanZi  
Chang Ping Town, Dong Guan City  
523571 Guang Dong Province  
China

# CERTIFICATE FI/41061

Our Ref. HEL-CERT210500497-01



**Product** Plug, non-rewirable

**Type** YP-22, with cord H03V2V2-F 3G0,75  
YP-22, with cord H03VV-F 3G0,75  
YP-22, with cord H05V2V2-F 3G0,75-1-1,5  
YP-22, with cord H05VV-F 3G0,75-1-1,5  
YP-22, with cord H05RN-F 3G0,75-1

**Trademark** YUNG-LI

**Certificate Holder** Yung Li Co., Ltd.  
Da Pu Industrial Zone, Gangzi Chang Ping Town, Dongguan, 523571, Guangdong, China

**Technical information** 16 A, 250 V~, IP20

**Other information** Standard sheet VII  
With angled cord entry

**The product is certified according to the following standard(s)** IEC 60884-1:2002 + A1:2006 + A2:2013  
SFS 5610:2015 + A11:2016

**Validity** This certificate is valid until 2026-05-18 provided that the Conditions for FI certification are met. This certificate includes the right to use the FI mark under the condition that changes (if any) will be checked at SGS Fimko before the product is brought onto market and that the conditions for FI certification are met.

**Date of issue** 2021-05-18

**SGS Fimko Ltd**

**Signature**

  
Joonas Leinonen  
Certification Manager





**Manufacturer** Yung Li Co., Ltd.  
Da Pu Industrial Zone, Gangzi Chang Ping Town, Dongguan, 523571,  
Guangdong, China

**Manufacturing site** Same as manufacturer

**Additional information** The product has certificate SE-S-2100166R1 issued by Intertek Semko  
AB in accordance with the Nordic Certification Service system.  
This certificate replaces previous certificate NCS/FI 29581, dated 2016-  
06-13, due to renewal of the certificate.

**As shown in the Test Report(s) No(s):** 2103009STO-001

ЕВРАЗИЙСКИЙ ЭКОНОМИЧЕСКИЙ СОЮЗ



СЕРТИФИКАТ СООТВЕТСТВИЯ

№ ЕАЭС ВУ/112 02.01. 020 09041

Серия ВУ № 0007501

**ОРГАН ПО СЕРТИФИКАЦИИ**

Открытое акционерное общество «Испытания и сертификация бытовой и промышленной продукции «БЕЛЛИС»; место нахождения: Республика Беларусь, 220029, г. Минск, ул. Красная, 7Б; место осуществления деятельности: Республика Беларусь, 220029, г. Минск, ул. Красная, 8; аттестат аккредитации № ВУ/112.020.02 от 03.08.1993; номер телефона: +243 17 243 16 41; адрес электронной почты: bellis@bellis.by

**ЗАЯВИТЕЛЬ**

Yung Li Co., Ltd., Da Pu Industrial Zone, Chang Ping Town, Dong Guan City, Guangdong, 523571, Китай

номер телефона: +86-769-83335989; адрес электронной почты: eng@yung-li.com

**ИЗГОТОВИТЕЛЬ**

Yung Li Co., Ltd., Da Pu Industrial Zone, Chang Ping Town, Dong Guan City, Guangdong, 523571, Китай

**ПРОДУКЦИЯ**

Вилка штепсельная неразборная с заземляющим контактом «YUNG LI»

модели УР-22, УР-23

серийный выпуск

**КОД ТН ВЭД ЕАЭС** 8544 42

**СООТВЕТСТВУЕТ ТРЕБОВАНИЯМ**

Технический регламент Таможенного союза «О безопасности низковольтного оборудования» ТР ТС 004/2011;

**СЕРТИФИКАТ СООТВЕТСТВИЯ ВЫДАН НА ОСНОВАНИИ**

протокола аккредитованной испытательной лаборатории «БЕЛЛИС», ВУ/112 1.0001, № 101-19-2255 от 26.09.2019,

отчета о проверке производства № 07-386/2019 от 26.09.2019

Схема сертификации: 1с

**ДОПОЛНИТЕЛЬНАЯ ИНФОРМАЦИЯ** ГОСТ ИЕС 60884-1-2013 Соединители электрические штепсельные бытового и аналогичного назначения. Часть 1. Общие требования и методы испытаний.

При поставках продукции на рынок стран ЕАЭС следует сообщить в орган по сертификации реквизиты компании-импортера (резидента страны ЕАЭС), которая является в соответствии с законодательством ответственной за качество поставляемой продукции, для дальнейшего включения этой информации в сертификат.

**СРОК ДЕЙСТВИЯ С 30.09.2019 ПО 29.09.2024 ВКЛЮЧИТЕЛЬНО**

Руководитель (уполномоченное лицо)  
органа по сертификации

Эксперт (эксперт-аудитор)  
(эксперты (эксперты- аудиторы))



Раковский  
Александр Григорьевич  
(Ф.И.О.)

Пепик  
Ольга Иосифовна  
(Ф.И.О.)



DEPARTMENT OF **FAIR TRADING**  
NSW Consumer Protection Agency

Certificate Number: 17665

# CERTIFICATE OF APPROVAL

ISSUED PURSUANT TO SECTION 21C OF THE ELECTRICITY SAFETY ACT 1945

ISSUED TO:

Yung Li Co Ltd

CLASS OF ARTICLE:

Appliance Connector

DESCRIPTION OF ARTICLE:

Appliance Connector  
(Side-entry, C13 appliance connector, for cold conditions, for Class I equipment,  
integrally moulded to any <HAR> certified H05VV-F 3G1.0mm<sup>2</sup>, or Australian  
approved three-core 1.00 mm<sup>2</sup>, PVC insulated and sheathed ordinary duty  
circular flexible cord)  
Trade Name: 'Yung Li'  
250V, ac, 10A

EXAMINED FOR COMPLIANCE WITH: AS/NZS 3109.1 : 1996 A1

TYPE REFERENCE CODE: Model No. YC-12L

APPROVAL MARK:

Each electrical article of the abovementioned type shall be marked with Approval Number  
N17665

DATE OF APPROVAL: 30 April 2001

This approval expires 30 April 2006 unless suspended, cancelled, renewed or extended.

for DIRECTOR-GENERAL

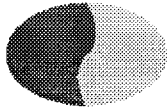

Ref: N17665/1

DEPARTMENT OF **FAIR TRADING**  
NSW Consumer Protection Agency

**ADDENDUM TO CERTIFICATE OF APPROVAL No 17665**

**Particulars of Modification(s)**

Original Model No. YC-12L alternatively moulded to any <HAR> certified H05VV-F 3G0.75mm<sup>2</sup>, or Australian approved three-core, 0.75mm<sup>2</sup>, PVC insulated and sheathed ordinary duty circular flexible cord not exceeding two metres in length.

Approved: 30 April 2001

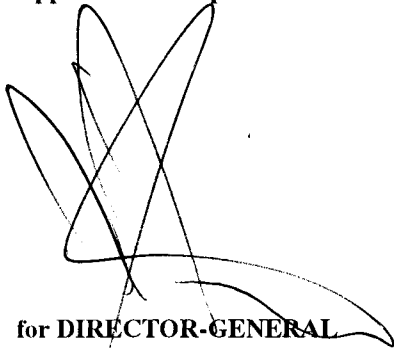

for **DIRECTOR-GENERAL**

Ref: 17665/2

**ADDENDUM TO CERTIFICATE OF APPROVAL 17665**

**Particulars of Modification(s)**

1. **Model No. YC-12L alternatively moulded to any <HAR> certified H05VV-F 3G1.5mm<sup>2</sup> or equivalent Australian approved three-core, 1.5mm<sup>2</sup>, PVC insulated and sheathed ordinary duty circular flexible cord.**
2. **General Modification:  
Model No. YC-12L now complies with AS/NZS 60320.1 : 2004.**

**Approved: 21 March 2006**



**for Commissioner for Fair Trading**



Fair  
Trading

Ref: NSW17665/5

## RENEWAL OF CERTIFICATE OF APPROVAL: NSW17665

### Particulars of Renewal

The approval of Appliance Connector Model No. YC-12L and approved modifications has been renewed for a period of FIVE years.

The Approval expires on 30/04/2021 unless it is renewed, extended, suspended or cancelled.

  
For Commissioner for Fair Trading



**ADDENDUM TO CERTIFICATE OF APPROVAL: NSW17665**

**Change of Particulars**

Change of Name			
Title:			
New Name:			
ABN:			
ACN:			
Postal Address:			
Suburb:		State:	
Postcode:		Country:	
Model Changes			
Title:			
Model Reference Code:			
Trade Name or Mark:			
Other Description:	Regulatory Compliance Mark (RCM) is not an appropriate exclusive mark to replace approval mark assigned in this certificate. However, RCM is not prohibited to be marked on the approved articles covered in this certificate, provided that the requirements of all relevant parts of AS/NZS 4417 applicable to the articles are fulfilled.		
Manufacturers Name:			
Postal Address:			
Suburb:		State:	
Postcode:		Country:	

This certificate will expire on 30/04/2021

Approved pursuant to Clause 16 (3) (b) of the Gas and Electricity (Consumer Safety) Regulation 2018:

 4 February 2021

For Secretary, Department of Customer Service



Fair  
Trading

Ref: NSW17665/7

## RENEWAL OF CERTIFICATE OF APPROVAL: NSW17665

### Particulars of Renewal

The approval of Appliance Connector Model No. YC-12L and approved modifications has been renewed for a period of FIVE years.

The Approval expires on 30/04/2026 unless it is renewed, extended, suspended or cancelled.

Approved pursuant to Clause 11 (1) of the Gas and Electricity (Consumer Safety) Regulation 2018

4 February 2021

For Secretary, Department of Customer Service



## ZEICHENGENEHMIGUNG MARKS APPROVAL

Yung-Li Co. Ltd.  
Da Pu Industrial Zone, Cang Zi  
Chang Ping Town  
523571 DONG GUAN CITY  
Guangdong  
CHINA

ist berechtigt, für ihr Produkt /  
*is authorized to use for their product*

**Starkstromleitungen für allgemeine Anwendungen**  
**- Flexible Leitungen**  
**mit thermoplastischer PVC-Isolierung**  
***Cables for general applications***  
***- Flexible cables with***  
***thermoplastic PVC insulation***

die hier abgebildeten markenrechtlich geschützten Zeichen  
für die ab Blatt 2 aufgeführten Typen zu benutzen /  
*the legally protected Marks as shown below for the types referred to on page 2 ff.*

◁VDE▷ oder/or ◁▷⊠▷ oder/or  schwarz  
black rot  
red

Geprüft und zertifiziert nach /  
*Tested and certified according to*

DIN EN 50525-2-11 (VDE 0285-525-2-11):2012-01; EN 50525-2-11:2011



Aktenzeichen: 1609800-5140-0005 / 211124

File ref.:

Ausweis-Nr. 40010145

Blatt 1

Certificate No.

Page

Weitere Bedingungen siehe Rückseite und Folgeblätter /  
*further conditions see overleaf and following pages*

Offenbach, 2004-04-27

(letzte Änderung / updated 2015-05-26 )

VDE Prüf- und Zertifizierungsinstitut GmbH  
VDE Testing and Certification Institute  
Zertifizierungsstelle / Certification

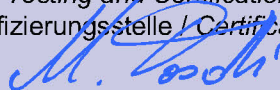

M. Tasotti

VDE Zertifikate sind nur gültig bei Veröffentlichung unter:  
VDE certificates are valid only when published on:

<http://www.vde.com/zertifikat>  
<http://www.vde.com/certificate>

Name und Sitz des Genehmigungs-Inhabers / *Name and registered seat of the Certificate holder*

Yung-Li Co. Ltd., Da Pu Industrial Zone, Cang Zi, Chang Ping Town, 523571 DONG GUAN CITY, Guangdong, CHINA

Aktenzeichen / *File ref.*

1609800-5140-0005 / 211124 / CC5 / HEG

letzte Änderung / *updated*

2015-05-26

Datum / *Date*

2004-04-27

Dieses Blatt gilt nur in Verbindung mit Blatt 1 des Zeichengenehmigungsausweises Nr. 40010145.

*This supplement is only valid in conjunction with page 1 of the Certificate No. 40010145.*

## Starkstromleitungen für allgemeine Anwendungen - Flexible Leitungen mit thermoplastischer PVC-Isolierung *Cables for general applications - Flexible cables with thermoplastic PVC insulation*

Typ(en) / *Type(s)*

H03VV-F 2...4 x 0,5...0,75 mm <sup>2</sup>	+
H03VVH2-F 2 x 0,5...0,75 mm <sup>2</sup>	+
H05VV-F 2...5 x 0,75...4 mm <sup>2</sup>	+
H05VVH2-F 2 x 0,75...1,0 mm <sup>2</sup>	+

Leitungsbauart  
*Type of cable*

Standardleitungen  
*General purpose cables*

Firmenzeichen  
*Trademark*

Yung Li Co., Ltd.

Dieser Zeichengenehmigungs-Ausweis bildet eine Grundlage für die EG-Konformitätserklärung und CE-Kennzeichnung durch den Hersteller oder dessen Bevollmächtigten und bescheinigt die Konformität mit den grundlegenden Schutzanforderungen der **EG-Niederspannungsrichtlinie 2006/95/EG** mit ihren Änderungen.  
*This Marks Approval is a basis for the EC Declaration of Conformity and the CE Marking by the manufacturer or his agent and proves the conformity with the essential safety requirements of the **EC Low-Voltage Directive 2006/95/EC** including amendments.*

VDE Prüf- und Zertifizierungsinstitut GmbH  
*VDE Testing and Certification Institute*  
Fachgebiet CC5  
*Section CC5*

Name und Sitz des Genehmigungs-Inhabers / *Name and registered seat of the Certificate holder*

Yung-Li Co. Ltd., Da Pu Industrial Zone, Cang Zi, Chang Ping Town, 523571 DONG GUAN CITY, Guangdong, CHINA

Aktenzeichen / *File ref.*

1609800-5140-0005 / 211124 / CC5 / HEG

letzte Änderung / *updated*

2015-05-26

Datum / *Date*

2004-04-27

Dieses Beiblatt ist Bestandteil des Zeichengenehmigungsausweises Nr. 40010145.

*This supplement is part of the Certificate No. 40010145.*

**Starkstromleitungen für allgemeine Anwendungen**  
**- Flexible Leitungen**  
**mit thermoplastischer PVC-Isolierung**  
***Cables for general applications***  
**- Flexible cables with**  
***thermoplastic PVC insulation***

**Fertigungsstätte(n)**

***Place(s) of manufacture***

Referenz/*Reference*  
**30008928**

Yung-Li Co. Ltd.  
Da Pu Industrial Zone, Cang Zi  
Chang Ping Town  
523571 DONG GUAN CITY  
Guangdong  
CHINA

VDE Prüf- und Zertifizierungsinstitut GmbH  
*VDE Testing and Certification Institute*  
Fachgebiet CC5  
*Section CC5*

Name und Sitz des Genehmigungs-Inhabers / Name and registered seat of the Certificate holder

Yung-Li Co. Ltd., Da Pu Industrial Zone, Cang Zi, Chang Ping Town, 523571 DONG GUAN CITY, Guangdong, CHINA

Aktenzeichen / File ref.

1609800-5140-0005 / 211124 / CC5 / HEG

letzte Änderung / updated

2015-05-26

Datum / Date

2004-04-27

Dieses Blatt gilt nur in Verbindung mit Blatt 1 des Zeichengenehmigungsausweises Nr. 40010145.

*This supplement is only valid in conjunction with page 1 of the Certificate No. 40010145.*

## **Genehmigung zum Benutzen des auf Seite 1 abgebildeten markenrechtlich geschützten Zeichens des VDE:**

Grundlage für die Benutzung sind die Allgemeinen Geschäftsbedingungen (AGB) der VDE Prüf- und Zertifizierungsinstitut GmbH ([www.vde.com\AGB-Institut](http://www.vde.com\AGB-Institut)). Das Recht zur Benutzung erstreckt sich nur auf die bezeichnete Firma mit den genannten Fertigungsstätten und die oben aufgeführten Produkte mit den zugeordneten Bezeichnungen. Die Fertigungsstätte muss so eingerichtet sein, dass eine gleichmäßige Herstellung der geprüften und zertifizierten Ausführung gewährleistet ist.

Die Genehmigung ist so lange gültig wie die VDE-Bestimmungen gelten, die der Zertifizierung zugrunde gelegen haben, sofern sie nicht auf Grund anderer Bedingungen aus der VDE Prüf- und Zertifizierungsordnung (PM102) zurückgezogen werden muss.

Der Gültigkeitszeitraum einer VDE-GS-Zeichengenehmigung kann auf Antrag verlängert werden. Bei gesetzlichen und / oder normativen Änderungen kann die VDE-GS-Zeichengenehmigung ihre Gültigkeit zu einem früheren als dem angegebenen Datum verlieren.

Produkte, die das Biozid Dimethylfumarat (DMF) enthalten, dürfen gemäß der Kommissionsentscheidung 2009/251/EG nicht mehr in den Verkehr gebracht oder auf dem Markt bereitgestellt werden.

Der VDE-Zeichengenehmigungsausweis wird ausschließlich auf der ersten Seite unterzeichnet.

### **Approval to use the legally protected Mark of the VDE as shown on the first page:**

*Basis for the use are the general terms and conditions of the VDE Testing and Certification Institute ([www.vde.com\terms-institute](http://www.vde.com\terms-institute)). The right to use the mark is granted only to the mentioned company with the named places of manufacture and the listed products with the related type references. The place of manufacture shall be equipped in a way that a constant manufacturing of the certified construction is assured.*

*The approval is valid as long as the VDE specifications are in force, on which the certification is based on, unless it is withdrawn according to the VDE Testing and Certification Procedure (PM102E).*

*The validity period of a VDE-GS-Mark Approval may be prolonged on request. In case of changes in legal and / or normative requirements, the validity period of a VDE-GS-Mark Approval may be shortened.*

*Products containing the biocide dimethylfumarate (DMF) may not be marketed or made available on the EC market according to the Commission Decision 2009/251/EC.*

*The approval is solely signed on the first page.*