

東莞永力電業有限公司

YUNG LI CO., LTD

Da Pu Industrial Zone, Gang Zi, Changping Town,
Dong Guan City, Guangdong 523571 China.P.R.C

TEL:0769-83396797~8

FAX:0769-83396796

E-mail: sales@yung-li.com

Description: YP-DE/YC-1J^?C

Customer: 2222_SY

Parts No. : 2222UT?1K?KB

Draw No. :

REVISION RECORD

1		
2		
3		
4		
5		

YUNG LI	
CHECKED	PREPARED BY

CUSTOMER	APPROVED

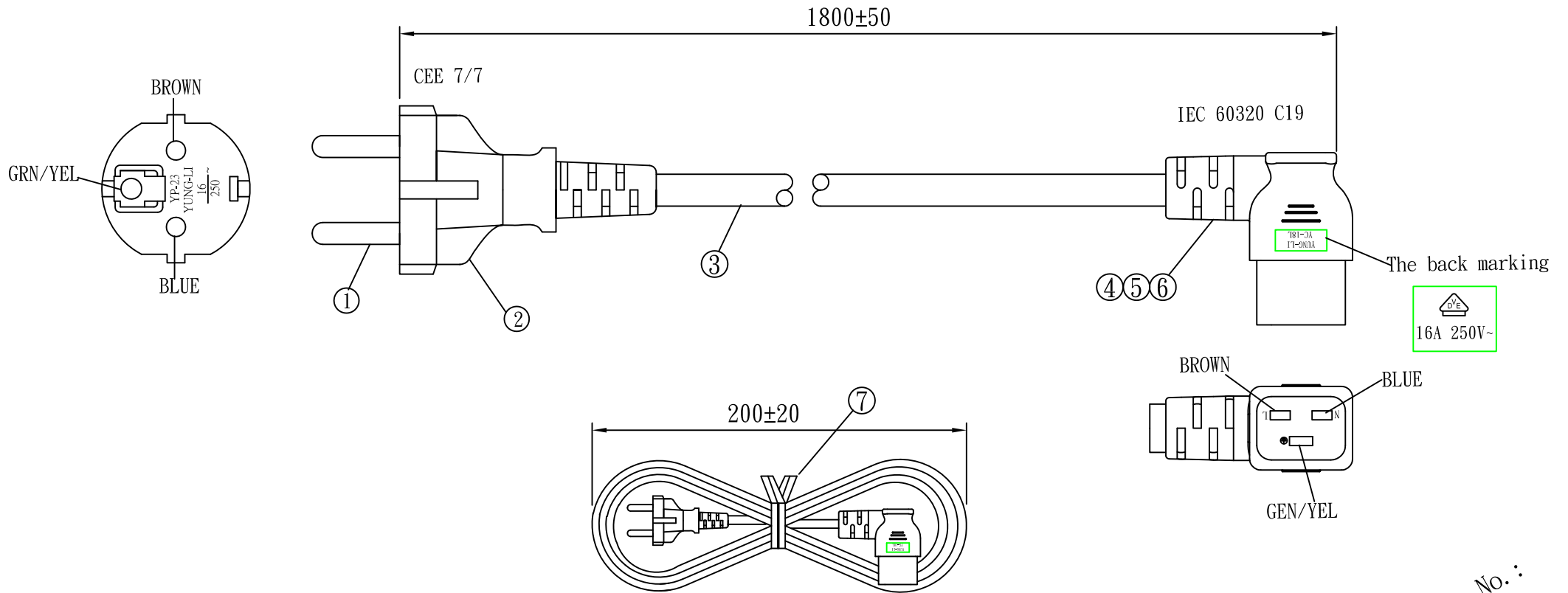

Sample Drawing No. :
SP121213-01

NO.	SPECIFICATION	Q' TY	REMARK
1	TER:98651 BLACK	1PC	
2	YP-23 PVC PLASTIC:50P BLACK	32g/PC	
3	H05VV-F 1.0/3C BLACK	1PC	
4	YC-18L PVC PLASTIC:50P BLACK	25g/PC	
5	YC-18L INNER BODY	1PC	
6	YC-18L TER:	3PCS	
7	MINI TIE:L=150mm BLACK	1PC	

Tolerance >0±0.30 >1.0±0.50 >10.0±1.0 >20.0±2.0 Angle: ±1°	Approved		Date		YUNG LI CO., LTD.			
	Checked		Date					
	Drawn	SUKI	Date	13.01.15	Customer	MAG		
	Cat. No.	YP-23/YC-18L-1			P/N.	CB-19-90		
	Drawing No.		Rev.	B	Material	P. V. C	Unit	mm
				Scale				

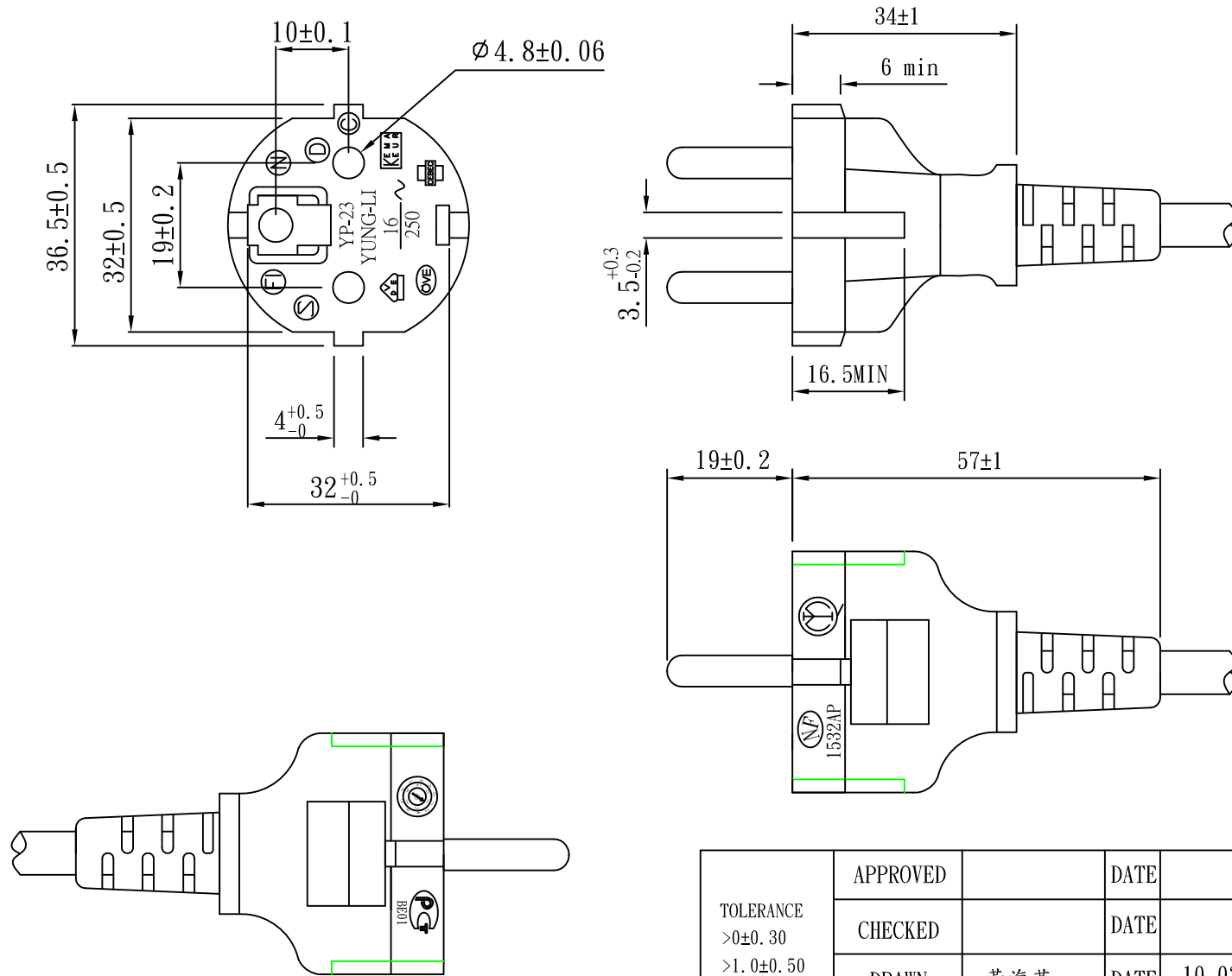
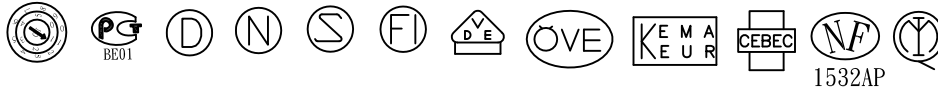

TOLERANCE >0±0.30 >1.0±0.50 >10.0±1.0 >20.0±2.0 Angle: ±1°	APPROVED		DATE		YUNG LI CO., LTD			
	CHECKED		DATE					
	DRAWN	黄海燕	DATE	10.03.23	CUSTOMER			
	TYPE	YP-23			P/N			
	DRAWING NO.	CY-P23V	REV	C	MATERIAL	P. V. C	UNIT	mm
				SCALE	1:1			

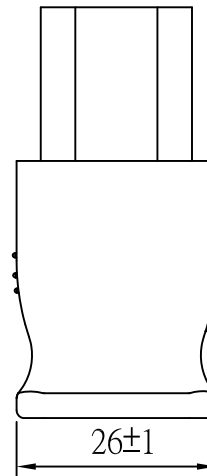
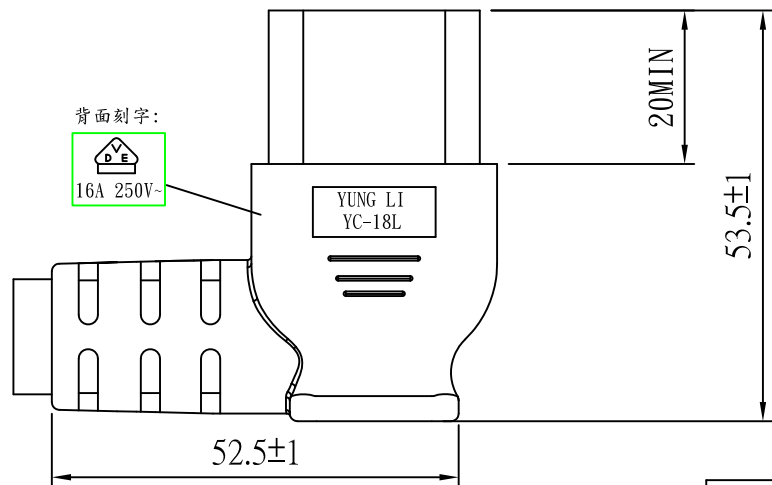
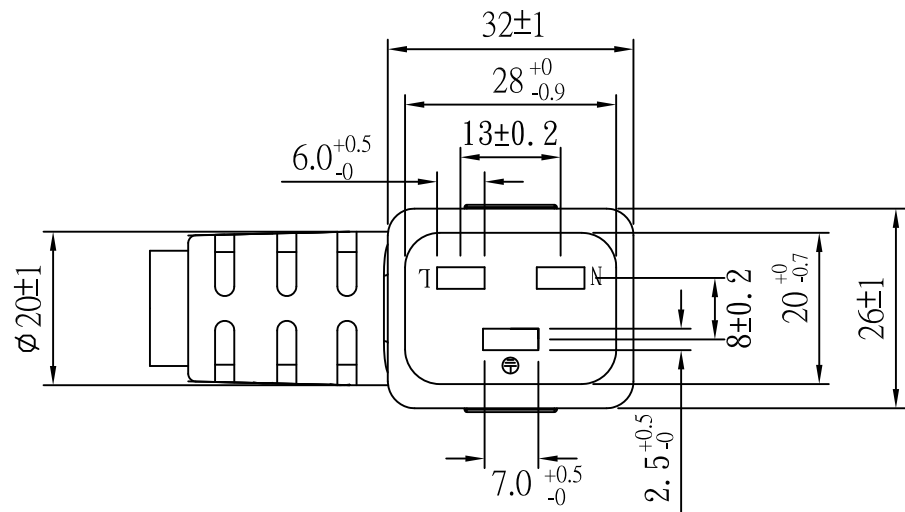

一般寸法公差: >0±0.30 >1.0±0.50 >10.0±1.0 >20.0±2.0 Angle: ±1°	核準		日期		永力電業有限公司 YUNG LI CO., LTD.			
	審核		日期					
	制圖	馮梅	日期	09.02.10	料號			
	型號	YC-18L-1			材質	P.V.C	單位	mm
圖號	CY-C18LV			比例	1:1			

YUNG LI CO., LTD

SPECIFICATION











Yung Li	Style	PVC FLEXIBLE CORDS	Document No
2012.7.18			YL-V01004
Edition	Size	H05VV-F 3G 1.0mm²	Page
A			1/2

1. Standard: IEC 60227 IEC 60228

2. Construction & Dimension

	Item	Specification
Conductor	Size	3G 1.0mm ²
	Material	Annealed Bare Copper
	Construction	32/ § 0.202±0.005
Insulation	Material	PVC
	Minimum Average Thickness	0.60mm
	Minimum Thickness at any point	0.48mm
	Diameter	2.50 ± 0.10
	Identification	Blue,Brown, Yellow/Green
Core Assembly	Core Twist	3-Core
	Filler	NA
	Assembly Pair	NA
Taping	Mylar Foil	NA
Shielded	A1-Mylar Foil	NA
Drain	Material	NA
	Construction	NA
Jacket	Material	NA
	Minimum Average Thickness	0.8mm
	Minimum Thickness at any point	0.58mm
	Overall Diameter(Approx)	7.0± 0.15
	Color	Any Color

Marking:

Yung Li Co., Ltd. H05VV-F 3G 1.0mm² <VDE> NF-USE 1347  KEMA-KEUR        IEMMEQU Q04083  A004049 60227 IEC 53(RVV) 300/500V  SU01027-4002

YUNG LI CO., LTD

SPECIFICATION

Yung Li	Style	PVC FLEXIBLE CORDS	Document No
2012.7.18			YL--V01004
Edition	Size	H05VV-F 3G 1.0mm²	Page
A			2/2

4. Electrical & Physical Properties

Item	Specification		
Rating Voltage	70°C 300/500V		
Conductor resistance(AT 20°C)	19.5Ω/Km MAX		
Insulation Resistance(AT 70°C)	0.010MΩ/Km Min		
Dielectric Strength	AC 2.0 KV / 15 min No Break		
Spark Test	5.0KV		
Insulation	Unaged	Tensile Strength	1.02 kgf/mm ² min
		Elongation	150% Min
	Aged	Tensile Strength	80~120% (80°C x168hrs)
		Elongation	80~120% (80°C x168hrs)
	Loss of mass Test		2.0mg/cm ² (max)
Jacket	Unaged	Tensile Strength	1.02 kgf/mm ² min
		Elongation	150% Min
	Aged	Tensile Strength	80~120% (80°C x168hrs)
		Elongation	80~120% (80°C x168hrs)
	Loss of mass Test		2.0mg/cm ² (max)
Deformation Test		70±4°C X 1hr ≤ 50%	
Cold Bend Test		-15°C x 4hr No Crack	
Heat Shock Test		150±2°C x 1hr No Crack	

Graph:

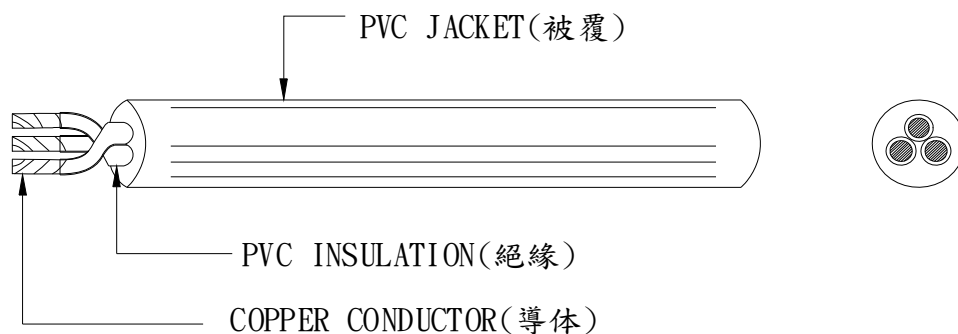

ZEICHENGENEHMIGUNG MARKS LICENCE

Yung-Li Co. Ltd.
Da Pu Industrial Zone
Chang Ping Town
523571 Dong Guan City
Guangdong
CHINA

ist berechtigt, für ihr Produkt /
is authorized to use for their product

Stecker nicht wiederanschließbar
Plug non-rewirable
YP-23

die hier abgebildeten markenrechtlich geschützten Zeichen
für die ab Blatt 2 aufgeführten Typen zu benutzen /
the legally protected Marks as shown below for the types referred to on page 2 ff.



Geprüft und zertifiziert nach /
Tested and certified according to

DIN VDE 0620-1 (VDE 0620 Teil 1):2002-01

VDE Prüf- und Zertifizierungsinstitut
VDE Testing and Certification Institute
Zertifizierungsstelle
Certification

Schliper

Aktenzeichen: 1609800-1560-0002 / 15248

File ref.:

Ausweis-Nr. 40003801

Blatt 1

Licence No.

Page

Weitere Bedingungen siehe Rückseite und Folgeblätter /
further conditions see overleaf and following pages

Offenbach, 2002-10-30

(letzte Änderung/updated 2003-12-09)

VDE Prüf- und Zertifizierungsinstitut Zeichengenehmigung

Ausweis-Nr. / Blatt /
Licence No. / page
40003801 2

Name und Sitz des Genehmigungs-Inhabers / *Name and registered seat of the Licence holder*
Yung-Li Co. Ltd., Da Pu Industrial Zone, Chang Ping Town, 523571 Dong Guan City, Guangdong,
CHINA

Aktenzeichen / *File ref.*
1609800-1560-0002 / 15248 / F330 / E

letzte Änderung / *updated* Datum / *Date*
2003-12-09 2002-10-30

Dieses Blatt gilt nur in Verbindung mit Blatt 1 des Zeichengenehmigungsausweises Nr. 40003801.
This supplement is only valid in conjunction with page 1 of the Licence No. 40003801.

Stecker nicht wiederanschließbar *Plug non-rewirable* YP-23

Typ(en) / *Type(s):*

YP-23

Bemessungsspannung AC 250 V
Rated voltage

Bemessungsstrom 16 A
Rated current

Polzahl 2-polig mit zwei Schutzkontaktsystemen
Number of poles 2-pole with two earthing contact systems

Bauart Normblatt: DIN 49441-R2
Kind of construction standard sheet: DIN 49441-R2

Schutzart nicht geschützt
Degree of protection ordinary

Fortsetzung siehe Blatt 3 /
continued on page 3





Testing & Certification

Kahlenberger Str. 2A
1190 Wien, Austria
Phone: +43 1 370 58 06
Fax: +43 1 370 58 06-199

ÖVE-CERTIFICATE

including the entitlement to use the Austrian Safety Mark



Certificate No.: **21721-007-02**

Valid from: 2011 04 30
until: 2013 04 30

The Austrian Electrotechnical Association (OVE) hereby grants the right to the company mentioned below to label the listed products with the Austrian Safety Mark.

Company: **Yung Li Co. Ltd.**
Da Pu Industrial Zone, Gang Zi, Chang Ping Town
523571 Dong Guan City, Guang Dong Province
China

Product: **Non rewirable two pole plug with dual earthing system**

Basis for this given right is the conformity of the products with the requirements of the technical standards listed in this certificate as stated in the file(s) Ref.-No(s). **1776-1199/03**.

This certificate establishes the conformity of the tested specimen and of all products manufactured strictly identical to the submitted one.

Österreichischer Verband für Elektrotechnik
Head of Testing & Certification



Vienna, 2011 02 28

Digitally signed by W. Martin
Email=w.martin@ove.at

Dipl.-Ing. W. Martin

OVE – Testing & Certification

Accredited by the Austrian Ministry of Economy, Family and Youth as Certification Body for products and processes in the field of electrical and electronic engineering, including safety and EMC





Manufacturer:

Yung Li Co. Ltd.
Da Pu Industrial Zone, Gang Zi, Chang Ping Town
523571 Dong Guan City, Guang Dong Province
China

Factory location(s):

Yung Li Co. Ltd.
Da Pu Industrial Zone, Gang Zi, Chang Ping Town
523571 Dong Guan City, Guang Dong Province
China

Tested and certified according to:

ÖVE/ÖNORM IEC 60884-1:2005-09-01

Product: Non rewirable two pole plug with dual earthing system

Type designation:
Rating:

Trademark:

YP-23

Rated voltage: AC 250 V
Rated current: 16 A
H03VV-F 3 G 0,75

YUNG LI

YP-23

Rated voltage: AC 250 V
Rated current: 16 A
H05VV-F 3 G 0,75

YUNG LI

YP-23

Rated voltage: AC 250 V
Rated current: 16 A
H05VV-F 3 G 1

YUNG LI

YP-23

Rated voltage: AC 250 V
Rated current: 16 A
H05VV-F 3 G 1,5

YUNG LI

OVE – Testing & Certification

Accredited by the Austrian Ministry of Economy, Family and Youth as Certification Body for products and processes in the field of electrical and electronic engineering, including safety and EMC





LCIE

Accréditation
N° 5-0014
Portée
disponible sur
www.cofrac.fr



LICENCE



LCIE N° 621359

Délivrée à:
Delivered to: **YUNG LI Co., Ltd**
1F, No 10, Lane 235, Pao-Chiang Road, Hsin-Tien - TAIPEI - TAIWAN

Site de fabrication:
Factory: **YUNG LI Co., Ltd. (1532AP)**
Da Pu Industrial Zone, Gang Zi, Chang Ping Town - Dong Guan City - GUANG DONG PROVINCE 523571 - CHINE

Produit:
Product: **Fiche de prise de courant**
Plug

Marque commerciale (s'il y a lieu):
Trade mark (if any): **YUNG-LI**

Modèle, type, référence:
Model, type, reference: **YP-23**

Caractéristiques nominales et principales:
Rating and principal characteristics: **16A 250V~, 2P avec contact de terre/2P with dual earthing contact**
voir annexe/see annex

Informations complémentaires:
Additional informations: **Mise à jour suite à évolution de la norme**
update further to the evolution of the standard

Le produit est conforme à:
The product is in conformity with: **NF C 61-314:2008 +A1:2010**

Documents pris en compte:
Relevant documents: **Rapport d'essai/test report n°BVCB11DE1039ACSP, certific d'essai**
OC/CB test certificate n°DE1-41647 / TR 1609800-1560 -0002/115256

Annule et remplace (s'il y a lieu):
Cancel and replaces (if necessary): **Licence n°555294/1 du 2007-02-26**

En vertu de la présente décision notifiée par le LCIE France organisme mandaté, AFNOR Certification accorde le droit d'usage de la Marque NF à la société qui en est titulaire pour les produits visés ci-dessus, dans les conditions définies par les règles générales de la Marque NF et par les règles de certification NF, pour autant que les contrôles réguliers de la fabrication et les vérifications par tierce partie soient satisfaisants.

On the strength of the present decision notified by LCIE France mandated certification body, AFNOR Certification grants the right to use the NF Mark to the licence holder for the above mentioned products, within the frame of the general rules of the NF Mark and of the NF certification rules, as far as the regular checking and third party verifications of the production are satisfactory.

Fontenay-aux-Roses, 2012-01-11

Michel BRENON
Directeur de la Certification
Certification Manager

Date limite de validité:
Limit expired date:

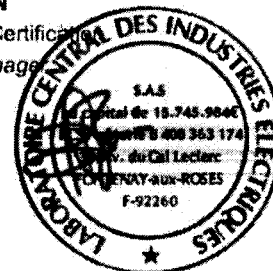

La validité de la présente licence cesse dès l'annulation de l'une des normes sur laquelle elle est fondée.
The present licence is valid until the cancellation of one of the standards on which it is based.

No. P03100429

Order No. 200312223

Applicant Yung-Li Co., Ltd.
1F, No. 10, Lane 235
Pao Chiang Rd., Hsin-Tien, Taipei
TAIWAN

Manufacturer Yung-Li Co., Ltd.
1F, No. 10, Lane 235
Pao Chiang Rd., Hsin-Tien, Taipei
TAIWAN

Factory Yung-Li Co., Ltd. China
Da Pu Industrial Zone
Chang Ping Town, Dong Guan City, Guang Dong Province
P.R. CHINA

Group 03 43000 Non-rewirable two-pole plug with dual earthing-contacts. Standard Sheet VII

Model/type YP-23

Data 16A 250V AC

Other specification Thermoplastic, with H03VV-F 3G0,75mm²

The above product is certified according to the following standard(s) Safety std.: IEC 60884-1 :02 + relevant parts of CEE7

Validity This certificate documents conformity with the standards shown, and also applies as license for use of Nemko's name and certification mark. The certificate and license is valid as long as the applicable conditions are complied with, and provided that any changes to the product are notified to Nemko for acceptance prior to implementation.
New standards or amendments to the standards may imply that the product design must be updated and/or that re-testing and re-certification is necessary.

Variants This Certificate also covers variants with Position No. from 001 to 001
See next page(s)

Date of issue 10 April 2003

signature

Ragnar Køltzow

Certification Department

No. P03100429

Order No. 200312223

Group 03 43000
Position No
Model/type
Data
Other specification

Non-rewirable two-pole plug with dual earthing-contacts. Standard Sheet VII
001
YP-23
16A 250V AC
Thermoplastic, with H05VV-F 3G0,75-1,5mm²

Date of issue 10 April 2003

signature

Ragnar Køltzow

Certification Department

Nemko AS
P.O. Box 73, Blindern
N-0314 Oslo, Norway

Office address
Gaustadalléen 30
Oslo

Telephone
+47 22 96 03 30
Enterprise number:

Fax
+47 22 96 05 50
NO 974404532

DEMKO CERTIFICATE

Certificate No. D-00818
Page 1/3
Date of Issue 2012-01-06

Certificate Holder YUNG LI CO LTD
DA PU INDUSTRIAL ZONE
CHANG PING TOWN
DONGGUAN, 523571 GUANGDONG China

Manufacturer YUNG LI CO LTD
DA PU INDUSTRIAL ZONE
CHANG PING TOWN
DONGGUAN, 523571 GUANGDONG China

Production site YUNG LI CO LTD
DA PU INDUSTRIAL ZONE
CHANG PING TOWN
DONGGUAN, 523571 GUANGDONG China

Certified Product Model Non-rewirable Two-pole plug with dual earthing contacts
YP-23

Trademark **YUNG LI**

Rated Voltage / Frequency 250 V~

Rated Current / Power 16 A

Insulation Class -

Degree of protection (IP) 20

Tested acc. to DS/IEC 60884-1:2004+A1:2007, SB 107-2-D1(ed.5)

Test Report No. 11CA62852 issued on 2012-01-05

Additional See Page 2

Expire date 2022-01-06

Certification Manager
Jan-Erik Storgaard

Certification Body

The product and production sites listed on the certificate comply with the D-mark requirements and the UL Global Service Agreement, with reference to Terms and Conditions for the D mark. The Owner of the certificate is entitled to use the δ or for cables «DEMKO», for the products listed on the certificate and manufactured at the production sites listed. UL has to be informed in writing about any changes to the product or production site in accordance with the Term and Conditions of the D mark. The validity of the certificate is shortened if the EU legislation require re-testing and re-certification due to new standards or amendments coming into force before the expiry date.

**UL International Demko A/S, Borupvang 5A, DK-2750Ballerup,
Denmark, Tel. +45 44 85 65 65, info.dk@ul.com
www.ul-europe.com**



Appendix DEMKO CERTIFICATE

Certificate No. D-00818
Page 2/3
Date of Issue 2012-01-06

Additional Information:

YP-23 with cord
H03VV-F 3G 0.75 mm²,
H05VV-F 3G 0.75, 1.0, 1.5 mm²,
H03V2V2-F 3G 0.75 mm²,
H05V2V2-F 3G 0.75, 1.0, 1.5 mm²,
H05RR-F 3G 0.75, 1.0, 1.5 mm²,
H05RN-F 3G 0.75, 1.0, mm²,
H07RN-F 3G 1.0, 1.5 mm²

Standard Sheet: C4 (CEE 7: VII)

This certificate replaces the certificate No. 311020-02 issued 2003-04-30.

UL International Demko A/S has issued a new certificate due to revise address of Applicant, Manufacturer and Factory.

Certification Body

UL International Demko A/S, Borupvang 5A, DK-2750 Ballerup,
Denmark, Tel. +45 44 85 65 65, info.dk@ul.com
www.ul-europe.com



Appendix DEMKO CERTIFICATE

Certificate No. D-00818
Page 3/3
Date of Issue 2012-01-06

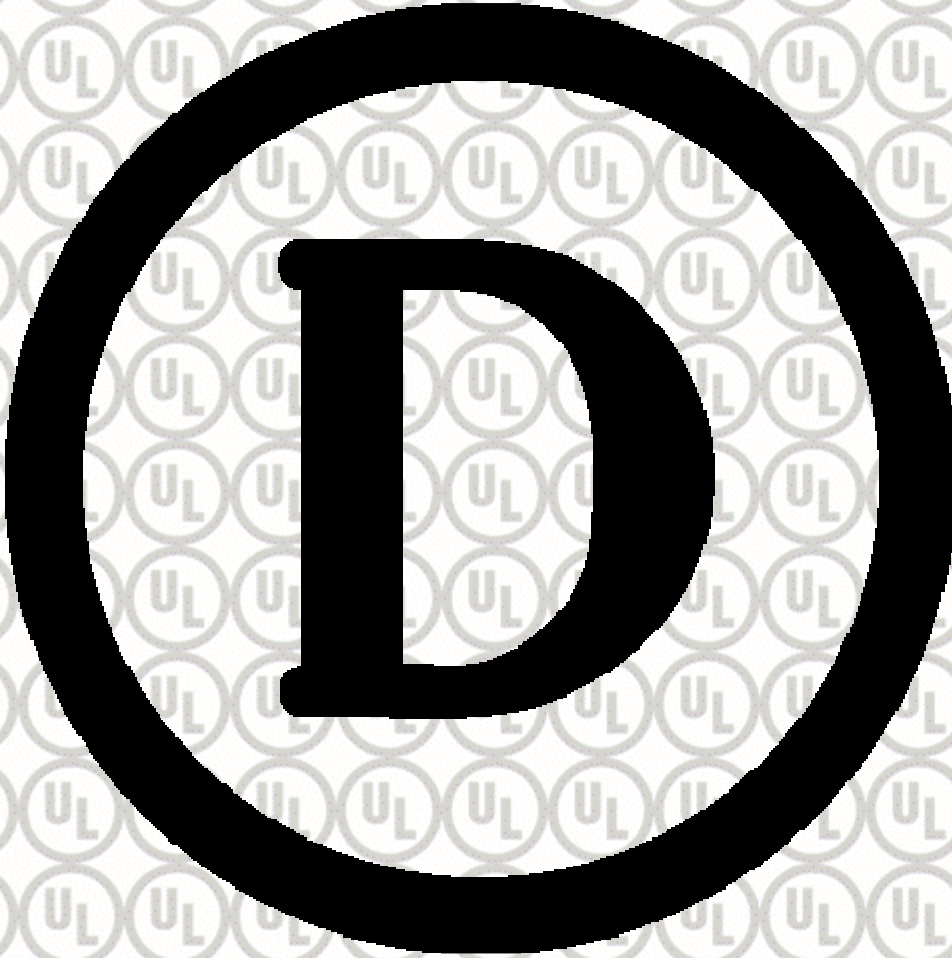

Certification Body

UL International Demko A/S, Borupvang 5A, DK-2750Ballerup,
Denmark, Tel. +45 44 85 65 65, info.dk@ul.com
www.ul-europe.com



Certificate



Intertek

for European Product Safety

Reference No. 1218960

Plug, non rewirable

Type designation	YP-23
Certificate holder	YUNG LI CO., LTD. 1F, No. 10, Lane 235 Pao-Chiao Road, Hsin-Tien, Taipei Taipei Hsien TAIWAN
The product complies with the standard(s)	IEC 60884-1:2002 and A1 SS 428 08 34:2004
Date of expiry	2 January 2018

Additional information in Appendix.

Certification Body Intertek Semko AB, Product Certification Place Kista - Stockholm

Signed

Håkan Eriksson

Date 28 December 2012
Page 1 of 2

This certificate is issued in accordance with the terms and conditions set out in the Appendix.





**Intertek
Appendix**

Reference No. 1218960

Technical data

Type designation	YP-23
Rated voltage (V)	250~
Rated current (A)	16
IP-Class	20
Type of cord	H03V2V2-F 3G0.75 mm ² H05V2V2-F 3G0.75-1.5 mm ² H03VV-F 3G0.75 mm ² H05VV-F 3G0.75-1.5 mm ²
Standard sheet	CEE 7/VII
Trade mark	YUNG-LI
Product information	Non rewirable plug for class I equipments

Manufacturing site(s) YUNG LI CO. LTD.
Da Pu Industrial Zone
Chang Ping Town
Dongguan City, Guang Dong
523571
CHINA

Certification Body Intertek Semko AB, Product Certification *Place* Kista - Stockholm

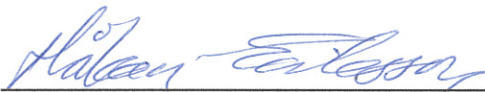
Signed 
Håkan Eriksson *Date* 28 December 2012

This Certificate is for the exclusive use of Intertek's Client and is provided pursuant to the Certification agreement between Intertek and its Client. Intertek's responsibility and liability are limited to the terms and conditions of the agreement. Intertek assumes no liability to any party, other than to the Client in accordance with the agreement, for any loss, expense or damage occasioned by the use of this certificate. Only the Client is authorized to permit copying or distribution of this certificate and then only in its entirety. Use of Intertek's Certification mark is restricted to the conditions laid out in the agreement. Any further use of the Intertek name for the sale or advertisement of the tested material, product or service must first be approved in writing by Intertek. Initial Factory Assessments and Follow up Services are for the purpose of assuring appropriate usage of the Certification mark in accordance with the agreement, they are not for the purposes of production quality control and do not relieve the Client of their obligations in this respect.

CERTIFICATE

KEMA No.: 2028043.01

Issued to:
Applicant:
**Central Point Consulting Co., Ltd.,
China Office
2B, Hua Jing Building, Wen
DONGGUAN, China**

Manufacturer/Licensee:
**Yung Li Co. Ltd.
1F, No.10, Lane 235
HSIN-TIEN, TAIPEI COUNTY, Taiwan**

Product : 2-pole plug with dual earthing contacts

Trade names : YUNG LI, YUNG-LI
Type : YP-23

The product and any acceptable variation thereto is specified in the Annex to this certificate and the documents therein referred to.

KEMA hereby declares that the above-mentioned product has been certified on the basis of:

- A type test according to the standard IEC 60884-1:2002
- an inspection of the production location according to CENELEC Operational Document CIG 021
- a certification agreement with the number 958361

KEMA hereby grants the right to use the KEMA-KEUR certification mark



The KEMA-KEUR certification mark may be applied to the product as specified in this certificate for the duration of the KEMA-KEUR certification agreement and under the conditions of the KEMA-KEUR certification agreement.

This certificate is issued on: March 14, 2003

H.R.M. Barends
Certification Manager

© Integral publication of this certificate is allowed

SGS



CERTIFICATE FI 26870

Our Ref. 264199

Product Plug, non-rewirable
Type YP-23, with cord H03VV-F 3G0,75
YP-23, with cord H03V2V2-F 3G0,75
YP-23, with cord H05VV-F 3G0,75-1-1,5
YP-23, with cord H05V2V2-F 3G0,75-1-1,5

Trade mark YUNG LI

Certificate Holder Yung-Li Co., Ltd.
Da Pu Industrial Zone, Chang Ping Town
Dongguan City 523571
GUANG DONG PROVINCE
CHINA

Manufacturer Yung-Li Co., Ltd.
Da Pu Industrial Zone, Chang Ping Town
Dongguan City 523571
GUANG DONG PROVINCE
CHINA

Technical information 16 A, 250 V~

Other information Standard sheet CEE 7 / VII, for class I equipments.

The product is certified according to the following standard(s) IEC 60884-1:2002 (Ed 3) + A1:2006
SFS 5610:2004 + A1:2008

Validity This certificate is valid until 14 June 2016 unless the standard in question has been amended or superseded with significant changes in requirements, in which case, SGS Fimko has the right to shorten the validity of the certificate based on the legislation of the European Union. This certificate includes the right to use the FI mark under the condition that changes (if any) will be checked at SGS Fimko before the product is brought onto market and that the conditions for FI certification are met.

Date of issue 14 June 2011

SGS Fimko Ltd

Signature

Osmo Väyrynen
Certification Manager



This certificate has 1 appendix



This certificate is issued by the company under its General Conditions for Certification Services accessible at www.sgs.com/terms_and_conditions.htm. Attention is drawn to the limitations of liability defined therein and in the Test Report here above mentioned which findings are reflected in this certificate. Any unauthorized alteration, forgery or falsification of the content or appearance of this document is unlawful and offenders may be prosecuted to the fullest extent of the law.

SGS Fimko Ltd.

Särkiniementie 3 P.O.Box 30 FI-00211 Helsinki, Finland
t. +358 9 696 381 f. +358 9 692 5474 www.fi.sgs.com

Business ID 0978538-5

Member of the SGS Group (SGS SA) Switzerland



Appendix to Certificate: 26870

Manufacturing sites Yung-Li Co., Ltd.
Da Pu Industrial Zone, Chang Ping Town
Dongguan City 523571
GUANG DONG PROVINCE
CHINA

Additional Information The product has certificate DE1-41647 issued by VDE Testing and Certification Institute in accordance with the CB system.

Our ref. 264199



LICENCE

No. 13085

Issued to:
Applicant:
Yung Li Co. Ltd.
1F, No.10, Lane 235,
Pao Chiang Road
HSIN-TIEN, TAIPEI
Taiwan

Licensee:
Yung Li Co. Ltd.
1F, No.10, Lane 235,
Pao Chiang Road
HSIN-TIEN, TAIPEI
Taiwan

Product : plugs (2-pole) for household purposes

Trade name(s) : YUNG-LI

Type(s)/model(s) : YP-23

The product and any acceptable variation thereto is specified in the annex to this licence and the documents therein referred to.

CEBEC hereby declares that the above-mentioned product has been certified on the basis of:

- a type test according to the standard specified in annex
- an inspection of the production location according to CCA Group Operational Document CIG 021
- a certification agreement with the number 1031

CEBEC hereby grants the right to use the CEBEC certification mark



The CEBEC certification mark may be applied to the product as specified in this licence for the duration of the CEBEC certification agreement and under the conditions of the CEBEC certification agreement.

This licence is issued on: 18/03/2003

ir. R. Maquestiau,
Managing Director

Only integral publication of this certificate, including the annex, is allowed

CEBEC srl/cvba

Avenue F. Van Kalkenlaan, 9A/b.1
B-1070 Bruxelles/Brussel
T: +32 (0)2 556 00 20
F: +32 (0)2 556 00 36

Accredited by



SPECIFICATION OF THE CERTIFIED PRODUCT**Product data**

Product	:	plugs (2-pole) for household purposes
Trade name(s)	:	YUNG-LI
Type(s)/Model(s)	:	YP-23
rated current (In)	:	16 A
rated voltage (Un)	:	250 Vac
earthing	:	with dual earthing system
design	:	non-rewirable
class	:	for class I appliances
standard sheet	:	VII
applied flexible cord(s)	:	H03 VV-F 3G0.75 mm ² H05 VV-F 3G0.75-1-1.5 mm ²
certification mark	:	complies with the requirements
cord(s) termination	:	crimped connection
description	:	body of thermoplastic material as part of an incomplete cord set for class I appliances
markings	:	are shown on the body

TESTS**Test requirements**

NBN C 61-112-1:1990 + A1:1993 + A2:1995 + A3:1999 + A4:2001

Test results

The test results are laid down in certification file ref.575659/01

Remarks

This certificate is based on certificate ref. CB DE 1-19771 and test report(s) ref. 1609800-1560-0002/24956

PID:
02113100
CID:
C.1996.5269

Certificato di approvazione

Approval certificate

IMQ, ente di certificazione accreditato, autorizza la ditta *IMQ, accredited certification body, grants to*

YUNG LI CO., LTD.
DA PU IND. ZONE, GangZi, CHANG PING TOWN
DONG GUAN CITY, GUANG DONG PROV.
CN - China

all'uso del marchio

the licence to use the mark

IMQ

Il presente certificato è soggetto alle condizioni previste nel "Regolamento IMQ - Certificazione prodotto" ed è relativo ai prodotti descritti nell'Allegato al presente certificato.



per i seguenti prodotti

for the following products

**Spine indissolubilmente
collegate al cavo
(Rif. di tipo YP-23)**

*Non-rewirable plugs
(Type ref. YP-23)*

This certificate is subjected to the conditions foreseen by "IMQ Rules - Product Certification" and is relevant to the products listed in the annex to this certificate.

Emesso il | Issued on **2003-06-25**
Aggiornato il | Updated on **2011-09-21**
Sostituisce | Replaces **2008-08-05**

IMQ S.p.A.

Allegato - Certificato di approvazione
Annex - Approval certificate

Emesso il / Issued on 2003-06-25
Aggiornato il / Updated on 2011-09-21
Sostituisce / Replaces 2008-08-05

Prodotto | Product

Spine indissolubilmente collegate al cavo
Non-rewirable plugs

Concessionario | Licence Holder

YUNG LI CO., LTD.
DA PU IND. ZONE, GangZi, CHANG PING TOWN
DONG GUAN CITY, GUANG DONG PROV.
CN - China

Marchio | Mark



IMQ

Costruito a | Manufactured at

PI.B000M3 C01175219

DONG GUAN CITY, GUANG DONG PROV.

China

Copia del presente certificato deve essere conservata presso i luoghi di produzione sopra elencati.

Copy of this certificate must be available at the manufacturing places listed above

Norme

CEI 23-50 - II Ed. 2007 + V1:2008

Standards

CEI 23-50 - II Ed. 2007 + V1:2008

Rapporti | Test Reports

26LL00073

Caratteristiche tecniche | Technical characteristics

Designazione | Type designation **2P+T+T S31 / 2P+E+E S31**
Tensione nominale | Rated voltage **250 V**
Corrente nominale | Rated current **16 A**
Grado di protezione | Degree of protection (IP) **IP20**
Tipo di morsetti | Type of terminals **morsetti aggraffati / crimped connections**
Materiale della custodia | Material of the cover **termoplastico / thermoplastic**
Uscita cavo | Cable exit **assiale / straight**

Articoli (con dettagli) | Articles (with details)

AR.D006AZ

Marca | Trade mark **YUNG LI**
Riferimento di tipo | Type reference **YP-23**
Articolo/Riferimento a catalogo | Article/Catalogue reference **YP-23**
Tipo di cavo | Type of cable **H03VV-F**
Sezione nominale | Section areas **3G0,75 mm²**

AR.D006B0

Marca | Trade mark **YUNG LI**
Riferimento di tipo | Type reference **YP-23**
Articolo/Riferimento a catalogo | Article/Catalogue reference **YP-23**
Tipo di cavo | Type of cable **H05VV-F**
Sezione nominale | Section areas **3G0,75 mm²**

AR.D006B1

Marca | Trade mark **YUNG LI**
Riferimento di tipo | Type reference **YP-23**

Articolo/Riferimento a catalogo | Article/Catalogue reference **YP-23**
Tipo di cavo | Type of cable **H05VV-F**
Sezione nominale | Section areas **3G1 mm²**

SN.D0009N.1

Marca | Trade mark **YUNG LI**
Riferimento di tipo | Type reference **YP-23**
Articolo/Riferimento a catalogo | Article/Catalogue reference **YP-23**
Tipo di cavo | Type of cable **H05VV-F**
Sezione nominale | Section areas **3G1,5 mm²**

Ulteriori informazioni | Additional Information

La spina rif. di tipo YP-23 è prodotta col seguente inserto:
marca: GEM ; art.: P98651.

The non-rewirable plug type ref. YP-23 is manufactured with the following insert:
trade mark: GEM; art.: P98651.

Componenti | Component List

Rif. di tipo/Type ref. YP-23

Tipo Type	(*)	Costruttore Manufacturer	Riferimento Type Ref.	Dati Data	Norme Standard (*)	Marchi Marks
Cavo / Cable	2/4	YUNG LI CO. LTD.	YUNG LI	H03VV-F 3G0,75mm ²	-	IMQ
Cavo / Cable	2/4	YUNG LI		H03VV-F	-	IMQ
Cavo / Cable	2/4	YUNG LI		H05VV-F	-	IMQ
Cavo / Cable	2/4	YUNG LI CO. LTD.	YUNG LI	H05VV-F 3G0,75 - 1 - 1,5mm ²	-	IMQ

Emesso il | Issued on **2011-09-21**

Data di aggiornamento | Updated on

Sostituisce | Replaces

Ciascun componente è contraddistinto da un numero avente il seguente significato:

- 1 - Componente marchiato e sostituibile con altro pure marchiato con caratteristiche equivalenti
- 2 - Componente sostituibile solo previa autorizzazione dell'IMQ
- 3 - Componente (integrato nell'apparecchio utilizzatore) provato congiuntamente all'apparecchio utilizzatore
- 4 - Componente in alternativa
- 5 - Componente per uso opzionale
- 6 - Componente da abbinare

Each component is signed by a number having the following meaning:

- 1 - Approved component replaceable with another one also approved with equivalent characteristics
- 2 - Component replaceable with IMQ authorization only
- 3 - Integrated component tested together with appliances
- 4 - Alternative component
- 5 - Component for optional use
- 6 - Component to be matched

(*) Queste colonne sono compilate a cura di IMQ / These columns are filled in by IMQ

Diritti di concessione | Annual Fees

SN.D0009N

BTL.021100.DA19

Diritti modelli IMQ - 0211 - Prese, spine e connettori di uso domestico | IMQ models - 0211 - Plugs and appliance couplers for domestic purposes

1



IMQ S.p.A.

СИСТЕМА СЕРТИФИКАЦИИ ГОСТ Р
ФЕДЕРАЛЬНОЕ АГЕНТСТВО ПО ТЕХНИЧЕСКОМУ РЕГУЛИРОВАНИЮ И МЕТРОЛОГИИ



СЕРТИФИКАТ СООТВЕТСТВИЯ

№ РОСС CN.AГ75.B00211

Срок действия с 18.05.2012 по 17.05.2015

№ 0820416

ОРГАН ПО СЕРТИФИКАЦИИ рег. № РОСС RU.0001.11AГ75.Общество с ограниченной ответственностью «ПродМашТест». 127015, Москва, Бумажный пр., 14, стр. 1, тел. (495) 7634799, факс (495) 7634799, E-mail prodmachtest@yandex.ru.

ПРОДУКЦИЯ Соединители электрические. Вилки неразборные УР-22, УР-23. Серийный выпуск.

КОД ОК 005 (ОКП):

34 6440

СООТВЕТСТВУЕТ ТРЕБОВАНИЯМ НОРМАТИВНЫХ ДОКУМЕНТОВ
ГОСТ Р 51322.1-99, ГОСТ Р 51322.2.4-99

КОД ТН ВЭД России:

8536 69 900 0

ИЗГОТОВИТЕЛЬ «Yung Li Co.,Ltd». Адрес: Da Pu Industrial Zone, 523571 Chang Ping Town, Dong Guan City, Guangdong, Китай.

СЕРТИФИКАТ ВЫДАН «Yung Li Co.,Ltd». Адрес: Da Pu Industrial Zone, 523571 Chang Ping Town, Dong Guan City, Guangdong, Китай.

НА ОСНОВАНИИ протокол испытаний № 1077-34 от 18.05.2012 г. Испытательная лаборатория ООО «ПродМашТест», рег. № РОСС RU.0001.21AB79 от 28.10.2011, адрес: 127015, Москва, Бумажный пр., 14, стр. 1

ДОПОЛНИТЕЛЬНАЯ ИНФОРМАЦИЯ Маркировка продукции знаком соответствия производится по ГОСТ Р 50460-92. Инспекционный контроль: 2013 г., 2014 г. Схема сертификации: З



Руководитель органа

[Signature]
Подпись

Мыльцев В. В.

инициалы, фамилия

Эксперт

[Signature]
Подпись

А.Е. Горев

инициалы, фамилия

Сертификат имеет юридическую силу на всей территории Российской Федерации

ZEICHENGENEHMIGUNG MARKS APPROVAL

Yung-Li Co. Ltd.
Da Pu Industrial Zone
Chang Ping Town
523571 Dong Guan City
Guangdong
CHINA

ist berechtigt, für ihr Produkt /
is authorized to use for their product

Gerätesteckdose, nicht-wiederanschließbar
Connector, non-rewirable

die hier abgebildeten markenrechtlich geschützten Zeichen
für die ab Blatt 2 aufgeführten Typen zu benutzen /
the legally protected Marks as shown below for the types referred to on page 2 ff.

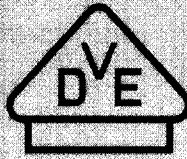

Geprüft und zertifiziert nach /
Tested and certified according to

DIN EN 60320-1 (VDE 0625 Teil 1):2002-06; EN 60320-1:2001



VDE Prüf- und Zertifizierungsinstitut
VDE Testing and Certification Institute
Zertifizierungsstelle / Certification

Dr. Schipper

Aktenzeichen: 1609800-1550-0012 / 96790
File ref.:

Ausweis-Nr. 40023682
Certificate No.

Blatt 1
Page

Weitere Bedingungen siehe Rückseite und Folgebätter /
further conditions see overleaf and following pages

Offenbach, 2008-03-11

VDE Zertifikate sind nur gültig bei Veröffentlichung unter:
VDE certificates are valid only when published on:

<http://www.vde.com/zertifikat>
<http://www.vde.com/certificate>

VDE Prüf- und Zertifizierungsinstitut Zeichengenehmigung

Ausweis-Nr. / Blatt
Certificate No. / page
40023682 2

Name und Sitz des Genehmigungs-Inhabers / *Name and registered seat of the Certificate holder*
Yung-Li Co. Ltd., Da Pu Industrial Zone, Chang Ping Town, 523571 Dong Guan City, Guangdong
CHINA

Aktenzeichen / *File ref.*
1609800-1550-0012 / 96790 / FG33 / E

Datum / *Date*
2008-03

Dieses Blatt gilt nur in Verbindung mit Blatt 1 des Zeichengenehmigungsausweises Nr. 40023682
This supplement is only valid in conjunction with page 1 of the Certificate No. 40023682.

Gerätesteckdose, nicht-wiederanschließbar *Connector, non-rewirable*

Typ(en) / *Type(s)*:

- 1 YC-18
- 2 YC-18L

Bemessungsspannung <i>Rated voltage</i>	AC 250 V
Bemessungsstrom <i>Rated current</i>	16 A
Polzahl <i>Number of poles</i>	2-polig mit Schutzkontakt <i>2-pole with earthing contact</i>
Bauart <i>Kind of construction</i>	Normblatt C19 <i>standard sheet C19</i>
Technische Daten <i>Technical data</i>	siehe Anlage Nr. 300A <i>see Appendix No. 300A</i> Für / <i>for</i> 1 siehe Anlage Nr. 400A <i>see Appendix No. 400A</i> Für / <i>for</i> 2

Dieser Zeichengenehmigungs-Ausweis bildet die Grundlage für die EG-Konformitätserklärung
CE-Kennzeichnung durch den Hersteller oder dessen Bevollmächtigten und bescheinigt die Konformität
mit den genannten Normen im Sinne der **EG-Niederspannungsrichtlinie 2006/95/EG**.
*This Marks Approval is the basis for the EC Declaration of Conformity and the CE Marking by
manufacturer or his agent and shows the conformity with the said standards as defined by the
Low-Voltage Directive 2006/95/EC.*

VDE Prüf- und Zertifizierungsinstitut
VDE Testing and Certification Institute
Fachgebiet FG33
Section FG33

VDE Prüf- und Zertifizierungsinstitut

ZEICHENGENEHMIGUNG MARKS APPROVAL

Yung-Li Co. Ltd.
Da Pu Industrial Zone, Cang Zi
Chang Ping Town
523571 DONG GUAN CITY
Guangdong
CHINA

ist berechtigt, für ihr Produkt /
is authorized to use for their product

Flexible Leitung
Flexible cable (cord)

die hier abgebildeten markenrechtlich geschützten Zeichen
für die ab Blatt 2 aufgeführten Typen zu benutzen /
the legally protected Marks as shown below for the types referred to on page 2 ff.



Gepprüft und zertifiziert nach /
Tested and certified according to

DIN VDE 0281-5 (VDE 0281 Teil 5):2002-09; HD 21.5 S3:1994 + A1:1999 + A2:2001

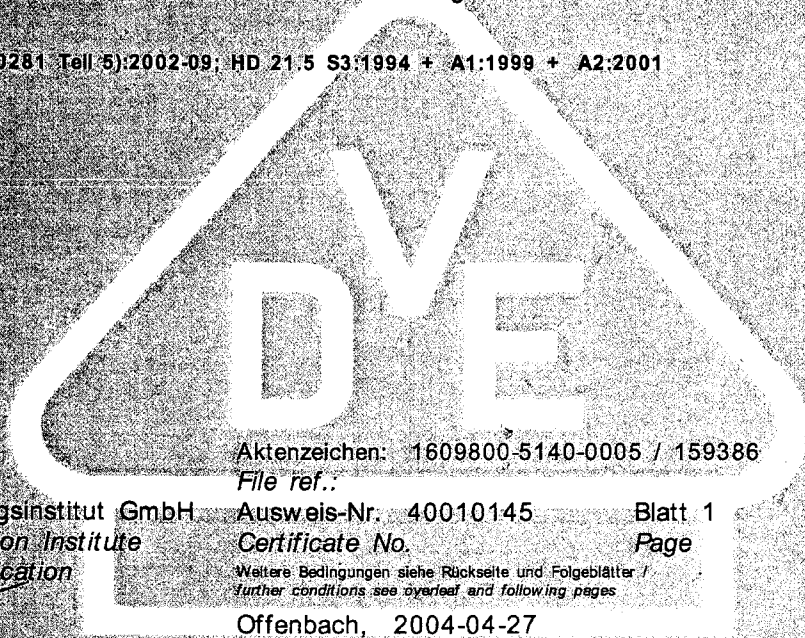

Aktenzeichen: 1609800-5140-0005 / 159386
File ref..

VDE Prüf- und Zertifizierungsinstitut GmbH
VDE Testing and Certification Institute
Zertifizierungsstelle / Certification

Ausweis-Nr. 40010145 Blatt 1
Certificate No. Page

Weitere Bedingungen siehe Rückseite und Folgeblätter /
further conditions see overleaf and following pages

Offenbach, 2004-04-27
(letzte Änderung/updated 2012-03-27)

K. Prohaska

VDE Zertifikate sind nur gültig bei Veröffentlichung unter:
VDE certificates are valid only when published on:

<http://www.vde.com/zertifikat>
<http://www.vde.com/certificate>

VDE



VDE Prüf- und Zertifizierungsinstitut Zeichengenehmigung

Ausweis-Nr. / Blatt /
Certificate No. page
40010145 2

Name und Sitz des Genehmigungs-Inhabers / *Name and registered seat of the Certificate holder*
Yung-Li Co. Ltd., Da Pu Industrial Zone, Cang Zi, Chang Ping Town, 523571 DONG GUAN CITY,
Guangdong, CHINA

Aktenzeichen / *File ref.*
1609800-5140-0005 / 159386 / FG42 / STR

letzte Änderung / *updated* Datum / *Date*
2012-03-27 2004-04-27

Dieses Blatt gilt nur in Verbindung mit Blatt 1 des Zeichengenehmigungsausweises Nr. 40010145
This supplement is only valid in conjunction with page 1 of the Certificate No. 40010145.

Flexible Leitung *Flexible cable (cord)*

Typ(en) / *Type(s)*:

H03VV-F 2...4 x 0,5...0,75 mm ²	+
H03VVH2-F 2 x 0,5...0,75 mm ²	+
H05VV-F 2...5 x 0,75...4 mm ²	+
H05VVH2-F 2 x 0,75...1,0 mm ²	+

Firmenzeichen YUNG LI
Trademark

Dieser Zeichengenehmigungs-Ausweis bildet eine Grundlage für die EG-Konformitätserklärung und CE-Kennzeichnung durch den Hersteller oder dessen Bevollmächtigten und bescheinigt die Konformität mit den grundlegenden Schutzanforderungen der **EG-Niederspannungsrichtlinie 2006/95/EG** mit ihren Änderungen.

This Marks Approval is a basis for the EC Declaration of Conformity and the CE Marking by the manufacturer or his agent and proves the conformity with the essential safety requirements of the EC Low-Voltage Directive 2006/95/EC including amendments.

VDE Prüf- und Zertifizierungsinstitut GmbH
VDE Testing and Certification Institute
Fachgebiet FG42
Section FG42