

東莞永力電業有限公司

YUNG LI CO., LTD

Da Pu Industrial Zone, Gang Zi, Changping Town,
Dong Guan City, Guangdong 523571 China.P.R.C

TEL:0769-83396797~8

FAX:0769-83396796

E-mail: sales@yung-li.com

Description: kb?EDAKU?CD

Customer: _SY

Parts No. :

Draw No. :

REVISION RECORD

1		
2		
3		
4		
5		

YUNG LI	
CHECKED	PREPARED BY

CUSTOMER	APPROVED



N/14885



N/14877

10000 ± 50

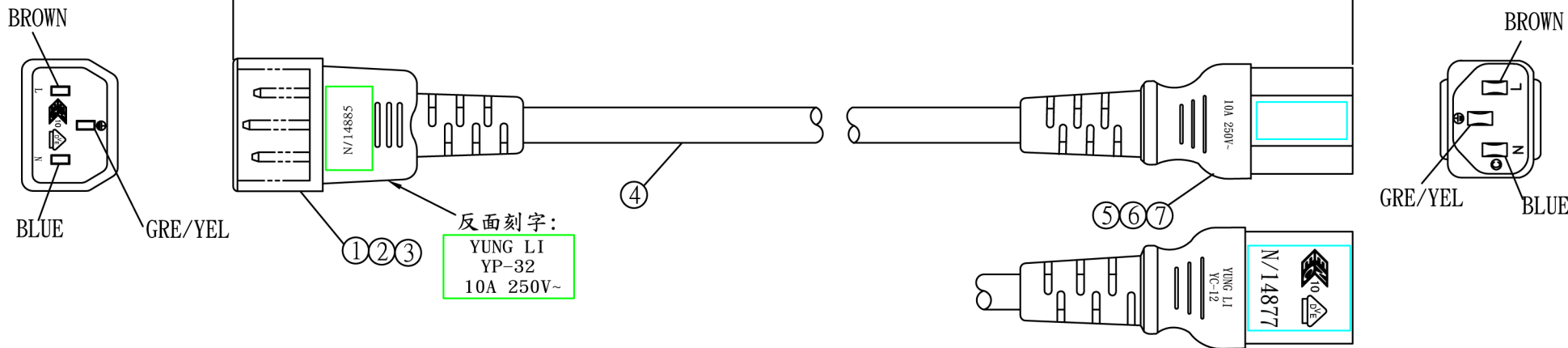

反面刻字:
YUNG LI
YP-32
10A 250V~

NO.	SPECIFICATION	Q' TY	REMARK
1	YP-32 PVC PLASTIC:50P BLACK	15g/PC	
2	TER:98672BS-1	3PCS	
3	INNER BODY: 2X4 BLACK (MARKING)	1PC	
4	H05VV-F 1.0/3C BLACK	1PC	
5	TER:97740	3PCS	
6	YC-12 INNER BODY	1PC	
7	YC-12 PVC PLASTIC:50P BLACK	18g/PC	
8	MINI TIE:L=180mm BLACK	1PC	

TOLERANCE >0±0.30 >1.0±0.50 >10.0±1.0 >20.0±2.0 Angle: ±1°	APPROVED		DATE		YUNG LI CO., LTD			
	CHECKED		DATE					
	DRAWN		DATE		CUSTOMER	MAG		
	TYPE	YP-32/YC-12			P/N	CB-K-10M		
	DRAWING NO.		REV	B	MATERIAL	P. V. C	UNIT	mm
				SCALE				



N/14885

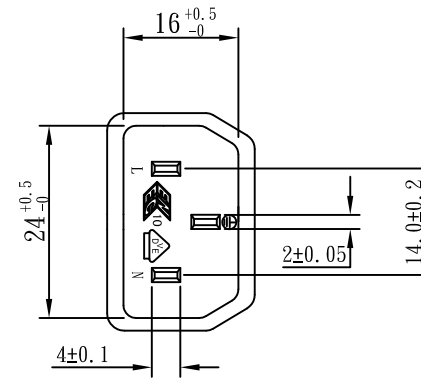
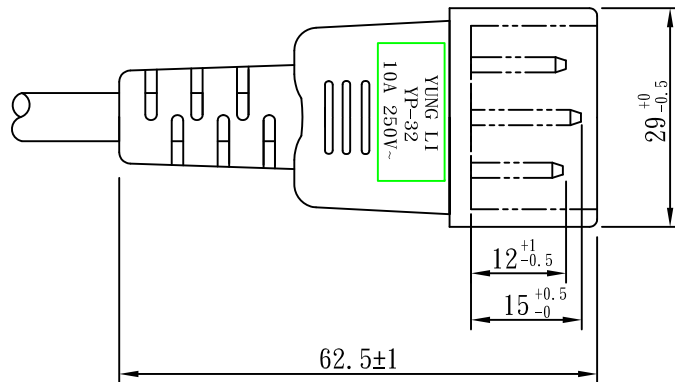
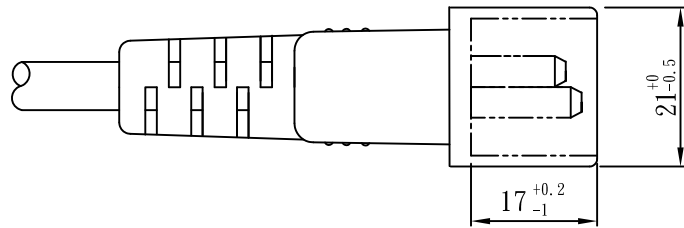
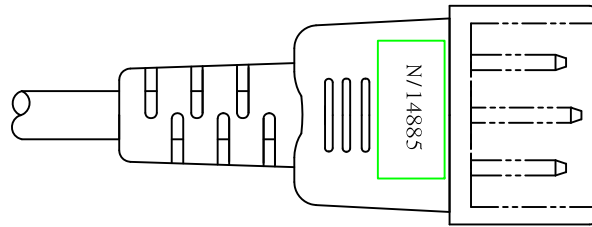

一般寸法公差: >0±0.30 >1.0±0.50 >10.0±1.0 >20.0±2.0 Angle: ±1°	核准		日期		東莞永力電業有限公司 YUNG LI CO., LTD.			
	審核		日期					
	制圖	羅生英	日期	11.04.22				
	型號	YP-32(10A)			料號			
	圖號	CY-P32V10A			材質	P.V.C	單位	mm
		比例	1:1					



N/14877

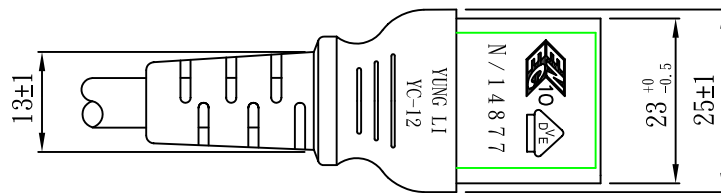
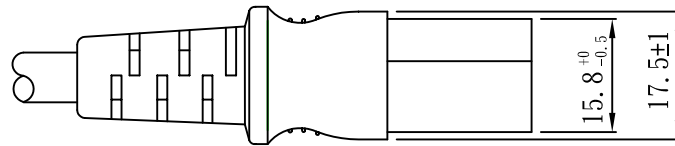
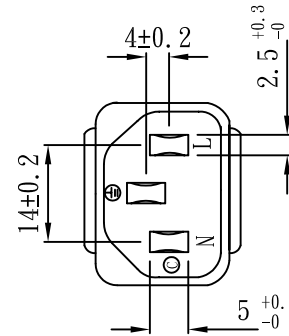
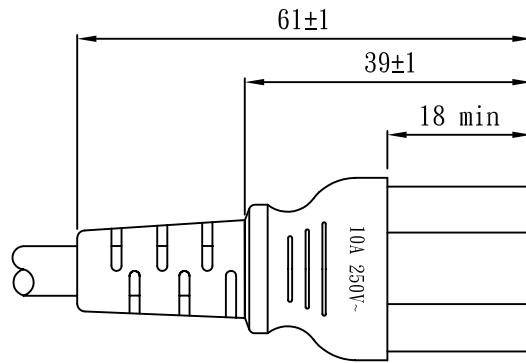

一般寸法公差： >0±0.30 >1.0±0.50 >10.0±1.0 >20.0±2.0 Angle： ±1°	核准		日期		東莞永力電業有限公司 YUNG LI CO., LTD.			
	審核		日期					
	制圖		日期					
	型號	YC-12(VDE)			料號			
圖號	CY-C12V10A250VB			材質	P.V.C	單位	mm	
				比例	1:1			

SPECIFICATION

TYPE	DESCRIPTION	PART NO.	PAGE
YP-32/YC-12	POWER SUPPLY CORD		1 of 3

1. SCOPE:

This specification applies to POWER SUPPLY CORDS which are in compliance with Carport neck DIN VDE 0620/06.87 and Carport nacho DIN VDE 0625 Tail 1/01.88(EN 60 320 Tail 1/09.86)

2. Standard of applicable

No.	Item	Type	Max. voltages	Max. current	File No.
2.1	Plug	YP-32	250V	10A	
2.2	Connector	YC-12	250V	10A	N/14877
2.3	Cord	H05VV-F 1.0/3C			

3. TEST CONDITION: This test and measurement, unless otherwise specified shall be carried out at a temperature of 15°C to 35°C, relative humidity of 25% to 85%, and atmospheric pressure of 86kpa to 106kpa.

However, when any doubt arises on the judgement value under it the test and measurement shall be carried out at a temperature of 20±2°C, relative humidity of 60% to 70%, and atmospheric pressure of 86kpa to 106kpa.

4.ELECTRICAL PERFORMANCE

NO.	Item	Test condition	Requirement
4-1	Dielectric Withstanding Voltage test	AC2500V is applied between a conductor and other conductor for 1 second. Loss of electric current at 1mA	No breakage
4-2	Current and Polarity test	L=L E=E N=N	No problem with Conductor
4-3	Insulation resistance test	In the air 20°C~60°C DC 500V	5MΩ / km MIN

SPECIFICATION

TYPE	DESCRIPTION	PART NO.	PAGE
YP-32/YC-12	POWER SUPPLY CORD		2 of 3

5. MECHANICAL PERFORMANCE

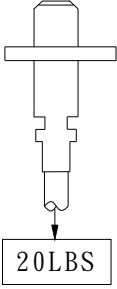
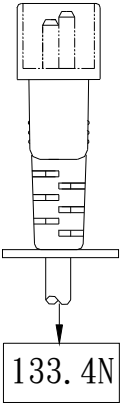
NO.	Item	Test condition	Requirement
5-1	Aging test	Exposure to $70\pm 2^{\circ}\text{C}$, atmosphere for 168 hours under natural ventilation.	No crack mucus mark wire exposure short and opposite polarity.
5-2	Input & output Force to connector	It is tested after taking the action of 10time input & output.	Applied force is 1~6kg
5-3	Pulling out force of terminal	<p>The connection between blade terminal and conductor shall not break under a pull force of 20lbs for 1minute</p> <div style="text-align: center;">  </div>	Blade can not fall down
5-4	Pulling out force of cord	<p>The joint in flexible cord is to be securely supported by a rigid flat mounted horizontally, a pull of 133.4N weight for one minute to the flexible cord</p> <div style="text-align: center;">  </div>	No looseness

SPECIFICATION

TYPE	DESCRIPTION	PART NO.	PAGE
YP-32/YC-12	POWER SUPPLY CORD		3 of 3

6.MECHANICAL PERFORMANCE

NO.	Item	Test condition	Requirement
6-1	Bending force	<p>The power supply cord division is fixing and load of 1000g is added to a tip of a cable. It is made to do 10000times bending on right and left each 45° (bending speed 60 times/minute)</p> <div style="text-align: center;"> </div>	Breaking rate is under 10%

YUNG LI CO., LTD

SPECIFICATION

Yung Li	Style	PVC FLEXIBLE CORDS	Document No
2005.09.23			
Edition	Size	H05VV-F 3G 1.0mm²	Page
A			1/2

1. Standard: IEC 227 IEC228

2. Construction & Dimension

	Item	Specification
Conductor	Size	3G 1.0mm ²
	Material	Annealed Bare Copper
	Construction	32/ 0.202±0.01
Insulation	Material	PVC
	Minimum Average Thickness	0.60mm
	Minimum Thickness at any point	0.48mm
	Diameter	2.50 ± 0.10
	Identification	Blue,Brown, Yellow/Green
Core Assembly	Core Twist	3-Core
	Filler	NA
	Assembly Pair	NA
Taping	Mylar Foil	NA
Shielded	A1-Mylar Foil	NA
Drain	Material	NA
	Construction	NA
Jacket	Material	NA
	Minimum Average Thickness	0.8mm
	Minimum Thickness at any point	0.58mm
	Overall Diameter(Approx)	7.0± 0.15
	Color	Any Color

Marking:

YUNG LI H05VV-F 3G 1.0mm² ◁VDE▷ NF-USE 1347 (NF) KEMA-KEUR △CEBEC ◁ÖVE▷ (D) (FI) (N)
 (S) (S) IEMMEQU Q04083 (CCC) A004049 60227 IEC 53(RVV) 300/500V (K) KTL SU01027-4002

YUNG LI CO., LTD

SPECIFICATION

Yung Li	Style	PVC FLEXIBLE CORDS	Document No
2005.09.23			
Edition	Size	H05VV-F 3G 1.0mm²	Page
A			2/2
4. Electrical & Physical Properties			
Item		Specification	
Rating Voltage		70 300/500V	
Conductor resistance(AT 20)		19.5 /Km MAX	
Insulation Resistance(AT 70)		0.010M /Km Min	
Dielectric Strength		AC 2.0 KV / 15 min No Break	
Spark Test		5.0KV	
Insulation	Unaged	Tensile Strength	1.02 kgf/mm ² min
		Elongation	150% Min
	Aged	Tensile Strength	80~120% (80 x168hrs)
		Elongation	80~120% (80 x168hrs)
	Loss of mass Test		2.0mg/cm ² (max)
Jacket	Unaged	Tensile Strength	1.02 kgf/mm ² min
		Elongation	150% Min
	Aged	Tensile Strength	80~120% (80 x168hrs)
		Elongation	80~120% (80 x168hrs)
	Loss of mass Test		2.0mg/cm ² (max)
Deformation Test		70±4 X 1hr 50%	
Cold Bend Test		-15 x 4hr No Crack	
Heat Shock Test		150±2 x 1hr No Crack	

Graph:



VDE Prüf- und Zertifizierungsinstitut

ZEICHENGENEHMIGUNG MARKS APPROVAL

Yung-U Co. Ltd.
Da Pu Industrial Zone
Chang Ping Town
523571 DONG GUAN CITY
Guangdong
CHINA

ist berechtigt, für ihr Produkt /
is authorized to use for their product

Geräteanschlußstecker, nichtwiederanschließbar
Plug connector, non-rewirable

die hier abgebildeten markenrechtlich geschützten Zeichen
für die ab Blatt 2 aufgeführten Typen zu benutzen /
the legally protected Marks as shown below for the types referred to on page 2 ff.



Geprüft und zertifiziert nach /
Tested and certified according to

DIN EN 60320-1 (VDE 0825-1):2008-05; EN 60320-1:2001 + A1:2007
DIN EN 60320-2-2 (VDE 0825 Teil 2-2):1999-09; EN 60320-2-2:1998



VDE Prüf- und Zertifizierungsinstitut GmbH
VDE Testing and Certification Institute
Zertifizierungsstelle / Certification

Aktenzeichen: 1609800-1550-0004 / 116608

File ref.:

Ausweis-Nr. 40029462

Blatt 1

Certificate No.

Page

Weitere Bedingungen siehe Rückseite und Folgebätter /
further conditions see overleaf and following pages

Offenbach, 2010-02-19

VDE Zertifikate sind nur gültig bei Veröffentlichung unter:
VDE certificates are valid only when published on:

<http://www.vde.com/zertifikat>
<http://www.vde.com/certificate>

VDE



Name und Sitz des Genehmigungs-Inhabers / *Name and registered seat of the Certificate holder*

Yung-Li Co. Ltd., Da Pu Industrial Zone, Chang Ping Town, 523571 DONG GUAN CITY, Guangdong,
CHINA

Aktenzeichen / *File ref.*

1609800-1550-0004 / 116608 / FG31 / E

Datum / *Date*

2010-02-19

Dieses Blatt gilt nur in Verbindung mit Blatt 1 des Zeichengenehmigungsausweises Nr. 40029462.
This supplement is only valid in conjunction with page 1 of the Certificate No. 40029462.

Geräteanschlußstecker, nichtwiederanschließbar
Plug connector, non-rewirable

Typ(en) / *Type(s)*:

YP-32

Bemessungsspannung
Rated voltage

AC 250 V

Bemessungsstrom
Rated current

10 A

Polzahl
Number of poles

2-polig mit Schutzkontakt
2-pole with earthing contact

Bauart
Kind of construction

Normblatt E
standard sheet E

PAK

Das Produkt entspricht den Anforderungen gemäß PAK-Dokument
ZEK 01.2-08.

PAH

*The product is in accordance with the requirements of
PAH-document ZEK 01.2-08.*

Produktinformation
Product information

siehe Anlage Nr. 300 + 900
see Appendix No. 300 + 900

Warenzeicheninhaber
Trademark holder

Yung-Li Co. Ltd.

Fortsetzung siehe Blatt 3 /
continued on page 3

VDE Prüf- und Zertifizierungsinstitut

ZEICHENGENEHMIGUNG MARKS APPROVAL

Yung-Li Co. Ltd.
Da Pu Industrial Zone
Chang Ping Town
523571 DONG GUAN CITY
Guangdong
CHINA

ist berechtigt, für ihr Produkt /
Is authorized to use for their product

Gerätesteckdose, nicht-wiederanschließbar
Connector, non-rewirable

die hier abgebildeten markenrechtlich geschützten Zeichen
für die ab Blatt 2 aufgeführten Typen zu benutzen /
the legally protected Marks as shown below for the types referred to on page 2 ff.



Geprüft und zertifiziert nach /
Tested and certified according to

DIN EN 60320-1 (VDE 0625-1):2008-05; EN 60320-1:2001 + A1:2007



VDE Prüf- und Zertifizierungsinstitut GmbH
VDE Testing and Certification Institute
Zertifizierungsstelle / Certification

Aktenzeichen: 1609800-1550-0003 / 116615

File ref.:

Ausweis-Nr. 40029577

Blatt 1

Certificate No.

Page

Weitere Bedingungen: siehe Rückseite und Folgebilder /
further conditions see overleaf and following pages

Offenbach, 2010-03-05

VDE Zertifikate sind nur gültig bei Veröffentlichung unter:
VDE certificates are valid only when published on:

<http://www.vde.com/zertifikat>
<http://www.vde.com/certificate>

VDE



VDE Prüf- und Zertifizierungsinstitut

Zeichengenehmigung

Ausweis-Nr. / Blatt /
Certificate No. page
40029577 2

Name und Sitz des Genehmigungs-Inhabers / *Name and registered seat of the Certificate holder*
Yung-Li Co. Ltd., Da Pu Industrial Zone, Chang Ping Town, 523571 DONG GUAN CITY, Guangdong,
CHINA

Aktenzeichen / *File ref.*
1609800-1550-0003 / 116615 / FG31 / E

Datum / *Date*
2010-03-05

Dieses Blatt gilt nur in Verbindung mit Blatt 1 des Zeichengenehmigungsausweises Nr. 40029577.
This supplement is only valid in conjunction with page 1 of the Certificate No. 40029577.

Gerätesteckdose, nicht-wiederanschließbar *Connector, non-rewirable*

Typ(en) / *Type(s)*:

- 1) YC-12
- 2) YC-12L

Bemessungsspannung
Rated voltage AC 250 V

Bemessungsstrom
Rated current 10 A

Polzahl
Number of poles 2-polig mit Schutzkontakt
2-pole with earthing contact

Bauart
Kind of construction Normblatt C13
standard sheet C13

Warenzeicheninhaber
Trademark holder Yung Li Co. Ltd.

Produktinformation
Product information siehe Anlage Nr. 300 + 400 + 900
see Appendix No. 300 + 400 + 900

PAK Das Produkt entspricht den Anforderungen gemäß PAK-Dokument
ZEK 01.2-08.

PAH *The product is in accordance with the requirements of*
PAH-document ZEK 01.2-08.

Fortsetzung siehe Blatt 3 /
continued on page 3

VDE Prüf- und Zertifizierungsinstitut GmbH * Testing and Certification Institute

ZEICHENGENEHMIGUNG MARKS APPROVAL

Yung-Li Co. Ltd.
Da Pu Industrial Zone
Chang Ping Town
523571 Dong Guan City
Guangdong
CHINA

ist berechtigt, für ihr Produkt /
is authorized to use for their product

Flexible Leitung
Flexible cable (cord)

die hier abgebildeten markenrechtlich geschützten Zeichen
für die ab Blatt 2 aufgeführten Typen zu benutzen /
the legally protected Marks as shown below for the types referred to on page 2 ff.

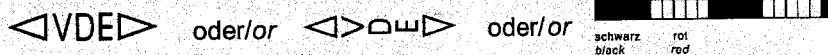

Geprüft und zertifiziert nach /
Tested and certified according to

DIN VDE 0281-5 (VDE 0281 Teil 5):2002-09; HD 21.5 S3:1994 + A1:1999 + A2:2001

VDE Prüf- und Zertifizierungsinstitut
VDE Testing and Certification Institute
Zertifizierungsstelle / Certification

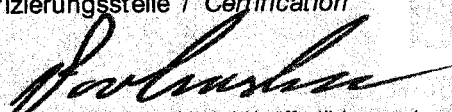
VDE Zertifikate sind nur gültig bei Veröffentlichung unter:
VDE certificates are valid only when published on:

Aktenzeichen: 1609800-5140-0005 / 82166

File ref.:

Ausweis-Nr. 40010145 Blatt 1

Certificate No. Page

Weitere Bedingungen siehe Rückseite und Folgeblätter /
further conditions see overleaf and following pages

Offenbach, 2004-04-27
(letzte Änderung/updated 2007-02-22)

<http://www.vde.com/zertifikat>
<http://www.vde.com/certificate>

VDE Prüf- und Zertifizierungsinstitut Zeichengenehmigung

Ausweis-Nr. / Blatt /
Certificate No. / page
40010145 2

Name und Sitz des Genehmigungs-Inhabers / *Name and registered seat of the Certificate holder*

Yung-Li Co. Ltd., Da Pu Industrial Zone, Chang Ping Town, 523571 Dong Guan City, Guangdong,
CHINA

Aktenzeichen / *File ref.*

1609800-5140-0005 / 82166 / FG42 / STR

letzte Änderung / *updated* Datum / *Date*

2007-02-22 2004-04-27

Dieses Blatt gilt nur in Verbindung mit Blatt 1 des Zeichengenehmigungsausweises Nr. 40010145.
This supplement is only valid in conjunction with page 1 of the Certificate No. 40010145.

Flexible Leitung *Flexible cable (cord)*

Typ(en) / *Type(s)*:

H03VV-F 2...4 x 0,5...0,75 mm²

+

H03VVH2-F 2 x 0,5...0,75 mm²

+

H05VV-F 2...5 x 0,75...2,5 mm²

+

H05VVH2-F 2 x 0,75...1,0 mm²

+

Firmenzeichen

YUNG LI

Trademark

Dieser Zeichengenehmigungs-Ausweis bildet die Grundlage für die EG-Konformitätserklärung und CE-Kennzeichnung durch den Hersteller oder dessen Bevollmächtigten und bescheinigt die Konformität mit den genannten Normen im Sinne der **EG-Niederspannungsrichtlinie 2006/95/EG**.

This Marks Approval is the basis for the EC Declaration of Conformity and the CE Marking by the manufacturer or his agent and shows the conformity with the said standards as defined by the EC Low-Voltage Directive 2006/95/EC.

VDE Prüf- und Zertifizierungsinstitut
VDE Testing and Certification Institute
Fachgebiet FG42
Section FG42