

東莞永力電業有限公司

YUNG LI CO., LTD

Da Pu Industrial Zone, Gang Zi, Changping Town,
Dong Guan City, Guangdong 523571 China.P.R.C

TEL:0769-83396797~8

FAX:0769-83396796

E-mail: sales@yung-li.com

Description: YP-DD/YC-12

Customer: _SY

Parts No. : 222UI?` ?CB_

Draw No. :

REVISION RECORD

1		
2		
3		
4		
5		

YUNG LI	
CHECKED	PREPARED BY

CUSTOMER	APPROVED

You will not be informed separately if we change any marking or indication on cables according with approval organization ' s requirement !

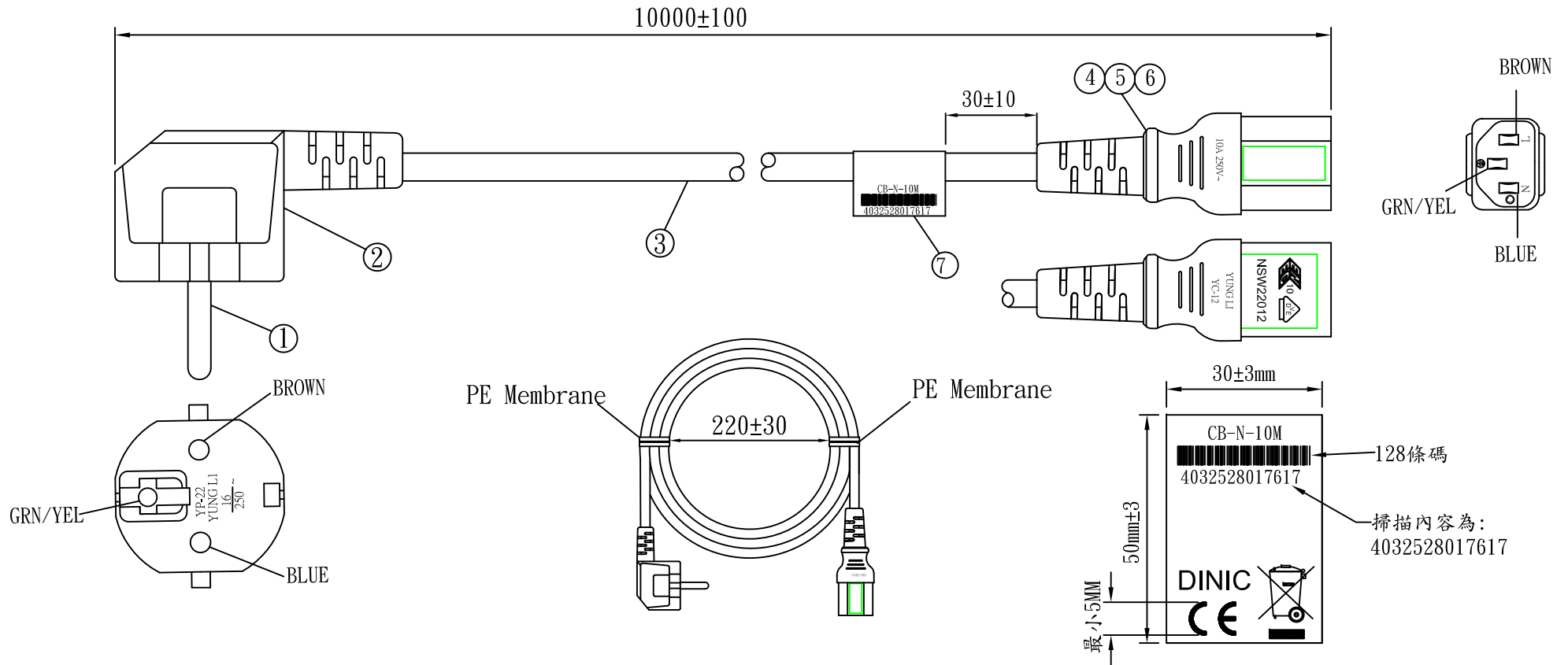
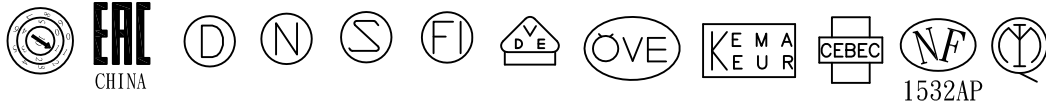

NO.	SPECIFICATION	QTY	REMARK
1	Euro plug inner model:98651	1PC	
2	YP-22 PVC PLASTIC:50P BLACK	34g/PC	
3	H05VV-F 1.5/3G BLACK CONCAVE	1PC	
4	TER:97740	3PCS	
5	YC-12 INNER BODY	1PC	
6	YC-12 PVC PLASTIC:50P BLACK	18g/PC	
7	LABEL:50x30mm	1PC	

Tolerance >0±0.30 >1.0±0.50 >10.0±1.0 >20.0±2.0 Angle: ±1°	Approved		Date		YUNG LI CO., LTD			
	Checked		Date					
	Drawn	SUKI	Date	20.08.12	Customer	MAG		
	Cat. No.	YP-22/YC-12			P/N.	CB-N-10M		
	Drawing No.	CY-V1360		Rev.	B	Material	P.V.C	Unit
					Scale			



1532AP

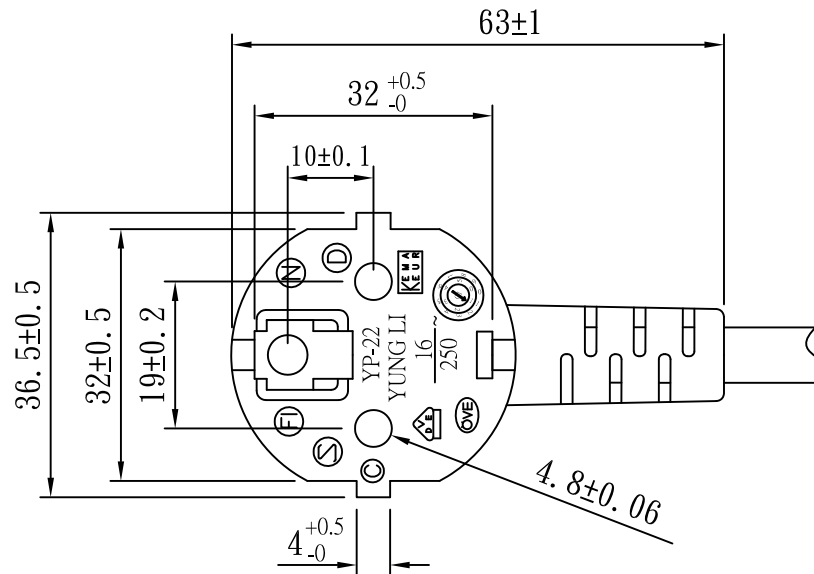
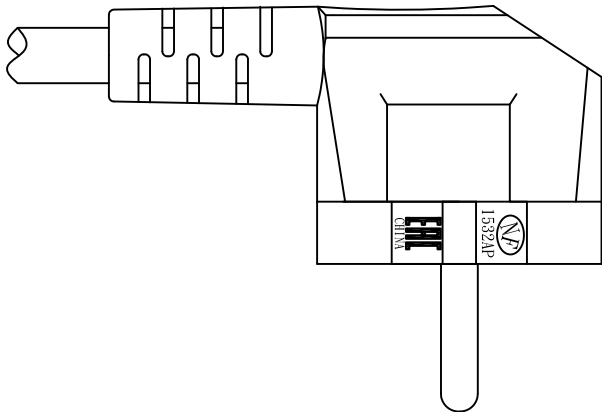
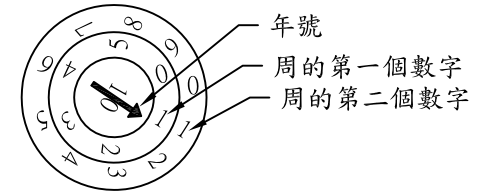
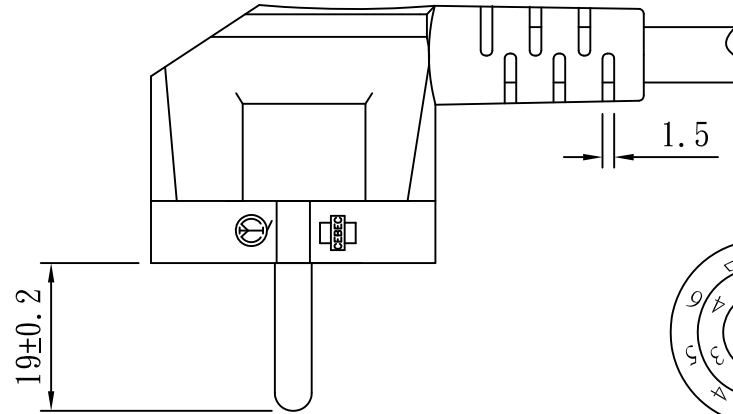
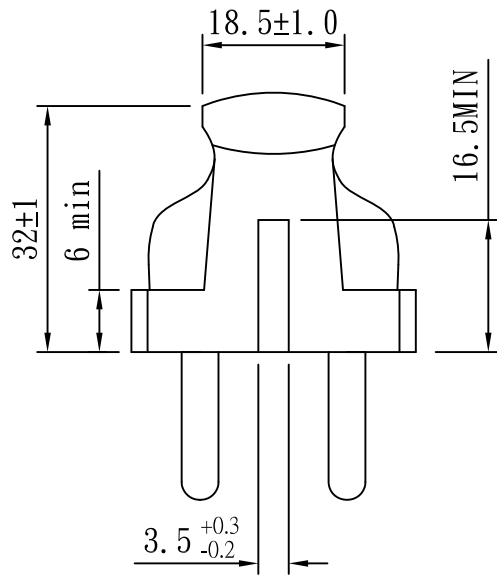

TOLERANCE >0±0.30 >1.0±0.50 >10.0±1.0 >20.0±2.0 Angle: ±1°	APPROVED		DATE		YUNG LI CO., LTD.			
	CHECKED		DATE					
	DRAWN		DATE					
	TYPE	YP-22			P/N			
	DRAWING NO				MATERIAL	P.V.C	UNIT	mm
					SCALE	1:1		



NSW22012

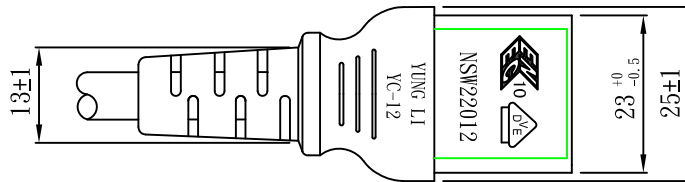
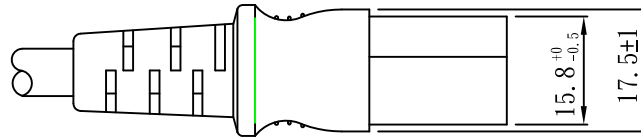
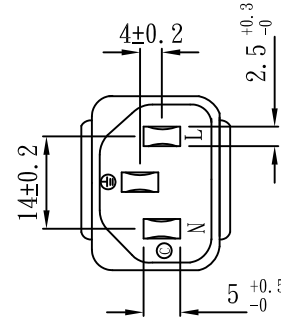
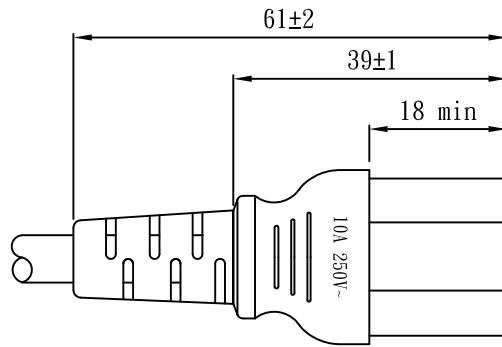

TOLERANCE >0±0.30 >1.0±0.50 >10.0±1.0 >20.0±2.0 Angle: ±1°	APPROVED		DATE		YUNG LI CO., LTD			
	CHECKED		DATE					
	DRAWN		DATE		CUSTOMER			
	TYPE	YC-12			P/N			
	DRAWING NO.		REV	B	SCALE	1:1	UNIT	mm

YUNG LI CO., LTD

SPECIFICATION

Yung Li	Style	PVC FLEXIBLE CORDS	Document No
2019.4.17			
Edition	Size	H05VV-F 3G 1.5mm²	Page
A			1/2







1. Standard: IEC 60227 IEC60228

2. Construction & Dimension

	Item	Specification
Conductor	Size	3G 1.5mm ²
	Material	Annealed Bare Copper
	Construction	48/ ϕ 0.202±0.01
Insulation	Material	PVC
	Minimum Average Thickness	0.70mm
	Minimum Thickness at any point	0.53mm
	Diameter	3.05± 0.10
	Identification	Blue,Brown,Green/Yellow
Core Assembly	Core Twist	3-Core
	Filler	NA
	Assembly Pair	NA
Taping	Mylar Foil	NA
Shielded	A1-Mylar Foil	NA
Drain	Material	NA
	Construction	NA
Jacket	Material	NA
	Minimum Average Thickness	0.9mm
	Minimum Thickness at any point	0.67mm
	Overall Diameter(Approx)	8.5± 0.15
	Color	Any colour

Marking:

Yung Li Co., Ltd. H05VV-F 3G 1.5mm² <VDE> NF-USE 1347  KEMA-KEUR  <OVE>

     IEMMEQU SAA-190646-EA  A004049 60227 IEC 53(RVV) 300/500V  SU01027-4002

YUNG LI CO., LTD

SPECIFICATION

Yung Li	Style	PVC FLEXIBLE CORDS	Document No
2019.4.17			
Edition	Size	H05VV-F 3G 1.5mm²	Page
A			2/2
4. Electrical & Physical Properties			
Item		Specification	
Rating Voltage		300/500V	
Maximum Temperature Rating		70°C	
Conductor resistance(AT 20°C)		13.3 Ω/Km Max	
Insulation Resistance(AT 70°C)		0.010MΩ/Km Min	
Dielectric Strength		AC 2.0 KV / 15MIN No Break	
Spark Test		5KV	
Insulation	Unaged	Tensile Strength	1.02 kgf/mm ² min
		Elongation	150% Min
	Aged	Tensile Strength	80~120% (80°C x168hrs)
		Elongation	80~120% (80°C x168hrs)
	Loss of mass Test		2.0mg/cm ² (max)
Jacket	Unaged	Tensile Strength	1.02 kgf/mm ² min
		Elongation	150% Min
	Aged	Tensile Strength	80~120% (80°C x168hrs)
		Elongation	80~120% (80°C x168hrs)
	Loss of mass Test		2.0mg/cm ² (max)
Deformation Test		70±4°C X 1hr ≤ 50%	
Cold Bend Test		-15°C x 4hr No Crack	
Heat Shock Test		150±2°C x 1hr No Crack	

Graph:

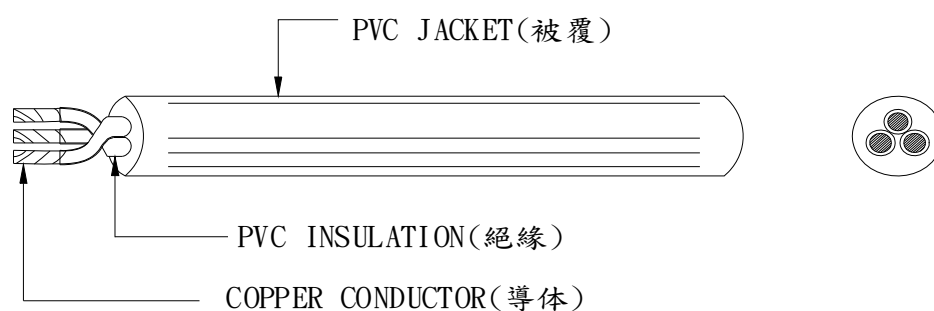

ZEICHENGENEHMIGUNG MARKS APPROVAL

Yung-Li Co. Ltd.
Da Pu Industrial Zone, Cang Zi
Chang Ping Town
523571 DONG GUAN CITY
Guangdong
CHINA

ist berechtigt, für ihr Produkt /
is authorized to use for their product

Stecker mit Schutzkontakt, nicht wiederanschließbar, umspritzt
Plug, with earthing contact, non-rewirable, moulded

die hier abgebildeten markenrechtlich geschützten Zeichen
für die ab Blatt 2 aufgeführten Typen zu benutzen /
the legally protected Marks as shown below for the types referred to on page 2 ff.



Geprüft und zertifiziert nach /
Tested and certified according to

DIN VDE 0620-2-1 (VDE 0620-2-1):2013-03



VDE Prüf- und Zertifizierungsinstitut GmbH
VDE Testing and Certification Institute
Zertifizierungsstelle / *Certification*

J. Gütermann
J. Gütermann

VDE Zertifikate sind nur gültig bei Veröffentlichung unter:
VDE certificates are valid only when published on:

Aktenzeichen: 1609800-1560-0002 / 178438

File ref.:

Ausweis-Nr. 40003878

Certificate No.

Blatt 1

Page

Weitere Bedingungen siehe Rückseite und Folgeblätter /
further conditions see overleaf and following pages

Offenbach, 2002-11-04

(letzte Änderung/updated 2013-05-13)

<http://www.vde.com/zertifikat>

<http://www.vde.com/certificate>

Name und Sitz des Genehmigungs-Inhabers / *Name and registered seat of the Certificate holder*
Yung-Li Co. Ltd., Da Pu Industrial Zone, Cang Zi, Chang Ping Town, 523571 DONG GUAN CITY,
Guangdong, CHINA

Aktenzeichen / *File ref.*
1609800-1560-0002 / 178438 / CC1 / SHA

letzte Änderung / *updated* Datum / *Date*
2013-05-13 2002-11-04

Dieses Blatt gilt nur in Verbindung mit Blatt 1 des Zeichengenehmigungsausweises Nr. 40003878
This supplement is only valid in conjunction with page 1 of the Certificate No. 40003878.

Stecker mit Schutzkontakt, nicht wiederanschließbar, umspritzt
Plug, with earthing contact, non-rewirable, moulded

Typ(en) / *Type(s)*:

YP-22

Bemessungsspannung <i>Rated voltage</i>	AC 250 V
Bemessungsstrom <i>Rated current</i>	16 A
Polzahl <i>Number of poles</i>	2-polig mit zwei Schutzkontaktsystemen <i>2-pole with two earthing contact systems</i>
Bauart <i>Kind of construction</i>	DIN 49441-R2
Schutzart <i>Degree of protection</i>	IP20
Produktinformation <i>Product information</i>	siehe Anlage Nr. 400A + 401A + 900A <i>see Appendix No. 400A + 401A + 900A</i>

VDE Prüf- und Zertifizierungsinstitut GmbH
VDE Testing and Certification Institute
Abteilung CC1
Section CC1



ÖVE-CERTIFICATE

including the entitlement to use the Austrian Safety Mark



Certificate No.: **21721-006-06**

Valid from: 2019 02 17
until: 2021 02 17

The Austrian Electrotechnical Association (OVE) hereby grants the right to the company mentioned below to label the listed products with the Austrian Safety Mark.

Company: **Yung Li Co. Ltd.**
Da Pu Industrial Zone, Gang Zi, Chang Ping Town
523571 Dong Guan City, Guang Dong Province
China

Product: **Non rewirable two pole plug with dual earthing system**

The products submitted by the applicant were type tested in accordance with the requirements of the technical standards and specifications listed in this certificate. OVE certifies the conformity of the listed products and those products manufactured strictly identical to the submitted ones (ISO/IEC 17067, Conformity Assessment Scheme Type 5).

The manufacturing process and the products are subject to ongoing surveillance based on harmonized European procedures. This certificate has been issued under the presumption and conditional on the fact that the applicant holds all necessary legal rights with regard to the product, presented for the testing and certification.

Results of testing are shown in file No(s): **1740-1182/03**

Österreichischer Verband für Elektrotechnik
Head of Testing & Certification

Digitally signed by W. Martin
Email=w.martin@ove.at

Dipl.-Ing. W. Martin

Vienna, 2019 01 09



OVE Testing & Certification

Accredited by the Federal Ministry for Digital and Economic Affairs as Certification Body for products within the scope as given in the official decree and published under www.bmdw.gv.at/akkreditierung.





Manufacturer:

Yung Li Co. Ltd.
Da Pu Industrial Zone, Gang Zi, Chang Ping Town
523571 Dong Guan City, Guang Dong Province
China

Factory location(s):

Yung Li Co. Ltd.
Da Pu Industrial Zone, Gang Zi, Chang Ping Town
523571 Dong Guan City, Guang Dong Province
China

Tested and certified according to:

ÖVE/ÖNORM IEC 60884-1:2005-09-01

Product: Non rewirable two pole plug with dual earthing system

Type designation:
Rating:

Trademark:

YP-22

Rated voltage: AC 250 V
Rated current: 16 A
H03VV-F 3 G 0,75

YUNG LI

YP-22

Rated voltage: AC 250 V
Rated current: 16 A
H05VV-F 3 G 0,75

YUNG LI

YP-22

Rated voltage: AC 250 V
Rated current: 16 A
H05VV-F 3 G 1

YUNG LI

YP-22

Rated voltage: AC 250 V
Rated current: 16 A
H05VV-F 3 G 1,5

YUNG LI

OVE Testing & Certification

Accredited by the Federal Ministry for Digital and Economic Affairs as Certification Body for products within the scope as given in the official decree and published under www.bmdw.gv.at/akkreditierung.





LCIE

Accréditation
N°5-0014
Portée
disponible sur
www.cofrac.fr



LICENCE



LCIE N° 621358

Délivrée à:
Delivered to: **YUNG LI Co., Ltd**
1F, No 10, Lane 235, Pao-Chiang Road, Hsin-Tien - TAIPEI - TAIWAN

Site de fabrication:
Factory: **YUNG LI Co., Ltd. (1532AP)**
Da Pu Industrial Zone, Gang Zi, Chang Ping Town - Dong Guan City - GUANG DONG PROVINCE 523571 - CHINE

Produit:
Product: **Fiche de prise de courant**
Plug

Marque commerciale (s'il y a lieu):
Trade mark (if any): **YUNG-LI**

Modèle, type, référence:
Model, type, reference: **YP-22**

Caractéristiques nominales et principales:
Rating and principal characteristics: **16A 250V~, 2P avec contact de terre/2P with dual earthing contact voir annexe/see annex**

Informations complémentaires:
Additional informations: **Mise à jour suite à évolution de la norme**
update further to the evolution of the standard

Le produit est conforme à:
The product is in conformity with: **NF C 61-314:2008 +A1:2010**

Documents pris en compte:
Relevant documents: **Rapport d'essai/test report n° BVCB11DE1038ACSP, certificat d'essai OC/CB test certificate n° DE1-42031 / TR 1609800-1560-0002/122934**

Annule et remplace (s'il y a lieu):
Cancels and replaces (if necessary): **Licence n°555296 du 2007-02-08**

En vertu de la présente décision notifiée par le LCIE France organisme mandaté, AFNOR Certification accorde le droit d'usage de la Marque NF à la société qui en est titulaire pour les produits visés ci-dessus, dans les conditions définies par les règles générales de la Marque NF et par les règles de certification NF, pour autant que les contrôles réguliers de la fabrication et les vérifications par tierce partie soient satisfaisants.

On the strength of the present decision notified by LCIE France mandated certification body, AFNOR Certification grants the right to use the NF Mark to the licence holder for the above mentioned products, within the frame of the general rules of the NF Mark and of the NF certification rules, as far as the regular checking and third party verifications of the production are satisfactory.

Fontenay-aux-Roses, 2012-01-11

Michel BRENON

Directeur de la Certification
Certification Manager

Date limite de validité :

Limit expired date :

La validité de la présente licence cesse dès l'annulation de l'une des normes sur laquelle elle est fondée.
The present licence is valid until the cancellation of one of the standards on which it is based.

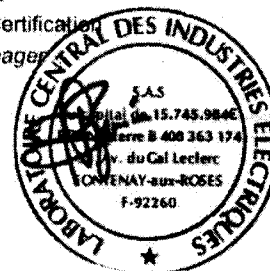

PID:
02113100
CID:
C.1996.5269

Certificato di approvazione

Approval certificate

IMQ, ente di certificazione accreditato, autorizza la ditta *IMQ, accredited certification body, grants to*

YUNG LI CO., LTD.
DA PU IND. ZONE, GangZi, CHANG PING TOWN
DONG GUAN CITY, GUANG DONG PROV.
CN - China

all'uso del marchio

the licence to use the mark

IMQ

Il presente certificato è soggetto alle condizioni previste nel "Regolamento IMQ - Certificazione prodotto" ed è relativo ai prodotti descritti nell'Allegato al presente certificato.



per i seguenti prodotti

for the following products

**Spine indissolubilmente
collegate al cavo
(Rif. di tipo YP-22)**

*Non-rewirable plugs
(Type ref. YP-22)*

This certificate is subjected to the conditions foreseen by "IMQ Rules - Product Certification" and is relevant to the products listed in the annex to this certificate.

Emesso il | Issued on **2003-04-17**
Aggiornato il | Updated on **2011-09-21**
Sostituisce | Replaces **2008-06-17**

IMQ S.p.A.

Allegato - Certificato di approvazione
Annex - Approval certificate

Emesso il / Issued on 2003-04-17
Aggiornato il / Updated on 2011-09-21
Sostituisce / Replaces 2008-06-17

Prodotto | Product

Spine indissolubilmente collegate al cavo
Non-rewirable plugs

Concessionario | Licence Holder

YUNG LI CO., LTD.
DA PU IND. ZONE, GangZi, CHANG PING TOWN
DONG GUAN CITY, GUANG DONG PROV.
CN - China

Marchio | Mark



IMQ

Costruito a | Manufactured at

PI.B000M3 C01175219

DONG GUAN CITY, GUANG DONG PROV.

China

Copia del presente certificato deve essere conservata presso i luoghi di produzione sopra elencati.

Copy of this certificate must be available at the manufacturing places listed above

Norme

CEI 23-50 - II Ed. 2007 + V1:2008

Standards

CEI 23-50 - II Ed. 2007 + V1:2008

Rapporti | Test Reports

26LL00072

Caratteristiche tecniche | Technical characteristics

Designazione | Type designation **2P+T+T S31 / 2P+E+E S31**
Tensione nominale | Rated voltage **250 V**
Corrente nominale | Rated current **16 A**
Grado di protezione | Degree of protection (IP) **IP20**
Tipo di morsetti | Type of terminals **morsetti aggraffati / crimped connections**
Materiale della custodia | Material of the cover **termoplastico / thermoplastic**
Uscita cavo | Cable exit **a squadra / angled**

Articoli (con dettagli) | Articles (with details)

AR.D0022W

Marca | Trade mark **YUNG-LI**
Riferimento di tipo | Type reference **YP-22**
Tipo di cavo | Type of cable **H03VV-F**
Sezione nominale | Section areas **3G0,75 mm²**

AR.D0022X

Marca | Trade mark **YUNG-LI**
Riferimento di tipo | Type reference **YP-22**
Tipo di cavo | Type of cable **H05VV-F**
Sezione nominale | Section areas **3G0,75 mm²**

AR.D0022Y

Marca | Trade mark **YUNG-LI**
Riferimento di tipo | Type reference **YP-22**
Tipo di cavo | Type of cable **H05VV-F**
Sezione nominale | Section areas **3G1 mm²**

AR.D0022Z

Marca / Trade mark **YUNG-LI**
Riferimento di tipo / Type reference **YP-22**
Tipo di cavo / Type of cable **H05VV-F**
Sezione nominale / Section areas **3G1,5 mm²**

Ulteriori informazioni | Additional Information

La spina rif. di tipo YP-22 è prodotta col seguente inserto:
marca: GEM ; art.: P98651.

The non-rewirable plug type ref. YP-23 is manufactured with the following insert:
trade mark: GEM; art.: P98651.

Componenti | Component List

Rif. di tipo/Type ref. YP-22

Tipo / Type	(*)	Costruttore / Manufacturer	Riferimento / Type Ref.	Dati / Data	Norme / Standard (*)	Marchi / Marks
Cavo / Cable	2/4	YUNG LI	YUNG LI	H03VV-F	-	IMQ
Cavo / Cable	2/4	YUNG LI	YUNG LI	H05VV-F	-	IMQ

Emesso il / Issued on **2008-06-17** Data di aggiornamento / Updated on **2011-09-21** Sostituisce / Replaces **2008-06-17**

Ciascun componente è contraddistinto da un numero avente il seguente significato:

- 1 - Componente marchiato e sostituibile con altro pure marchiato con caratteristiche equivalenti
- 2 - Componente sostituibile solo previa autorizzazione dell'IMQ
- 3 - Componente (integrato nell'apparecchio utilizzatore) provato congiuntamente all'apparecchio utilizzatore
- 4 - Componente in alternativa
- 5 - Componente per uso opzionale
- 6 - Componente da abbinare

Each component is signed by a number having the following meaning:

- 1 - Approved component replaceable with another one also approved with equivalent characteristics
- 2 - Component replaceable with IMQ authorization only
- 3 - Integrated component tested together with appliances
- 4 - Alternative component
- 5 - Component for optional use
- 6 - Component to be matched

(*) Queste colonne sono compilate a cura di IMQ / These columns are filled in by IMQ

Diritti di concessione | Annual Fees

SN.D000DL BTL.021100.DA19 Diritti modelli IMQ - 0211 - Prese, spine e connettori di uso domestico | IMQ models - 0211 - Plugs and appliance couplers for domestic purposes

1



IMQ S.p.A.

DEMKO CERTIFICATE

Certificate No. D-06167
Page 1/3
Date of Issue 2017-10-24

Certificate Holder Yung Li Co Ltd
7F-12 No 99 Sec 1 Xintai 5th Rd
Xizhi District
New Taipei, 22175 Taiwan

Manufacturer Yung Li Co Ltd
7F-12 No 99 Sec 1 Xintai 5th Rd
Xizhi District
New Taipei, 22175 Taiwan

Production site Yung Li Co Ltd
Da Pu Industrial Zone
Gangzi Chang Ping Town
Dongguan, 523571 Guangdong China

Certified Product Model Non-rewirable, Two-pole plug with dual earthing contacts
YP-22
Trademark YUNG LI

Rated Voltage / Frequency 250 V ~
Rated Current / Power 16 A
Insulation Class -
Degree of protection (IP) 20
Tested acc. to DS 60884-2-D1:2017
Test Report No. 4788152169 issued on 2017-10-24
Additional This certificate replaces the earlier issued certificate No.D-05356
Expire date 2026-06-12

Certification Manager
Jan-Erik Storgaard

This is to certify that representative sample(s) of the Product described herein ("Certified Product") have been investigated and found in compliance with the Standard(s) indicated on this Certificate, in accordance with the D Mark Requirements. The Designated Certificate holder is entitled to use the d or for cables <DEMKO> for the Certified Product manufactured at the production site(s) identified above, in accordance with the D Mark Service Agreement, including without limitation the D Mark Testing and Certification Services Service Terms. Only those Products bearing the D Mark should be considered as being covered by UL's D Mark Service. This Certificate shall remain valid through the expiration date, unless terminated earlier in accordance with the Service Agreement including without limitation if the Standard identified on this Certificate is amended or withdrawn prior the expiration date.

Certification Body

UL International Demko A/S, Borupvang 5A, DK-2750
Ballerup, Denmark, Tel. +45 44 85 65 65, info.dk@ul.com
www.ul-europe.com



Appendix DEMKO CERTIFICATE

Certificate No. D-06167
Page 2/3
Date of Issue 2017-10-24

External Certification Information:
FI 9308, issued on 2016-06-13 by SGS Fimko Ltd

Additional Information:
For class I equipment
Standard Sheet:
C4 (DS 60884-2-D1)
VII (CEE 7)

Flexible Cord:
YP-22 with H03VV-F 3G0.75 mm²
YP-22 with H05VV-F 3G0.75-1.0-1.5 mm²
YP-22 with H03V2V2-F 3G0.75 mm²
YP-22 with H05V2V2-F 3G0.75-1.0-1.5 mm²
YP-22 with H05RN-F 3G0.75-1.0 mm²

Certification Body

UL International Demko A/S, Borupvang 5A, DK-2750
Ballerup, Denmark, Tel. +45 44 85 65 65, info.dk@ul.com
www.ul-europe.com



Appendix DEMKO CERTIFICATE

Certificate No. D-06167
Page 3/3
Date of Issue 2017-10-24

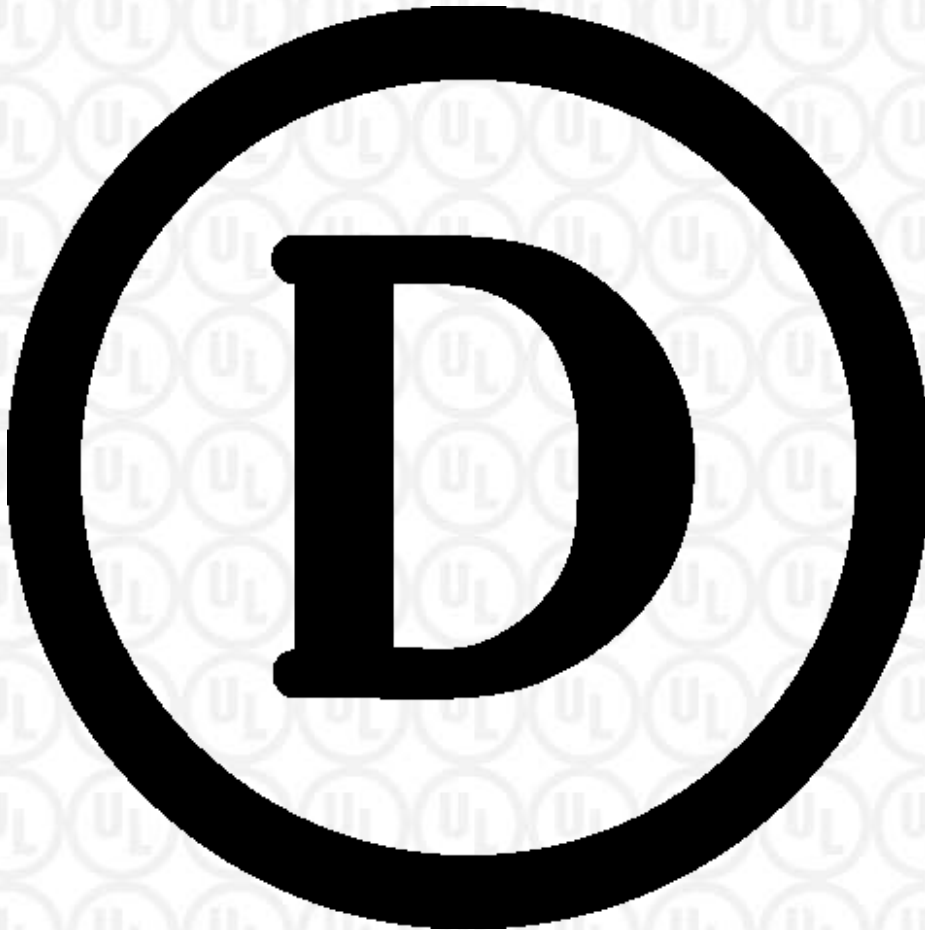

Certification Body

UL International Demko A/S, Borupvang 5A, DK-2750
Ballerup, Denmark, Tel. +45 44 85 65 65, info.dk@ul.com
www.ul-europe.com



Product	Plugs
Applicant	Yung Li Co., Ltd. China Da Pu Industrial Zone, Chang Ping Town, Dong Guan City, Guangdong Province 523571 China
Manufacturer	Yung Li Co., Ltd. China Da Pu Industrial Zone, Chang Ping Town, Dong Guan City, Guangdong Province 523571 China
Factory	Yung Li Co., Ltd. China Da Pu Industrial Zone, Chang Ping Town, Dong Guan City, Guangdong Province 523571 China
Ratings	16A 250V AC
Trade mark	YUNG LI
Model / Type Ref.	YP-22
Principal characteristics	Non-rewirable plug, Standard Sheet VII, with H03VV-F 3G0.75mm ²
A sample of the product was tested and found to be in conformity with	INST IEC 60884-1:2002, IEC 60884-1:2002/AMD1:2006, IEC 60884-1:2002/AMD2:2013 NEK 502:2016
Validity	This certificate documents conformity with the standards shown, and also applies as license for use of Nemkos name and certification mark. The certificate and license is valid as long as the applicable conditions are complied with, and provided that any changes to the product are notified to Nemko for acceptance prior to implementation. New standards or amendments to the standards may imply that the product design must be updated and/or that re-testing and re-certification is necessary.
Additional information	
Additional model(s)	(4) See page 2

Date of issue 01-03-2017



Sweet Yuan

Certification Department

Nemko AS

Gaustadalléen 30, P.O. Box 73 Blindern, 0314 Oslo, Norway
TEL +47 22 96 03 30 FAX +47 22 96 05 50 EMAIL info@nemko.com
ENTERPRISE NUMBER NO974404532

Additional model(s)

Product	Plugs
Pos. No	1
Model / Type Ref.	YP-22
Trade mark (if different from page 1)	
Rating	16A 250V AC
Principal characteristics	Non-rewirable plug, Standard Sheet VII, with H05VV-F 3G0.75-1-1.5mm ²
Product	Plugs
Pos. No	2
Model / Type Ref.	YP-22
Trade mark (if different from page 1)	
Rating	16A 250V AC
Principal characteristics	Non-rewirable plug, Standard Sheet VII, with H03V2V2-F 3G0.75mm ²
Product	Plugs
Pos. No	3
Model / Type Ref.	YP-22
Trade mark (if different from page 1)	
Rating	16A 250V AC
Principal characteristics	Non-rewirable plug, Standard Sheet VII, with H05V2V2-F 3G0.7-1-1,5mm ²
Product	Plugs
Pos. No	4
Model / Type Ref.	YP-22
Trade mark (if different from page 1)	
Rating	16A 250V AC
Principal characteristics	Non-rewirable plug, Standard Sheet VII, with H05RN 3G0.75-1mm ²

Date of issue 01-03-2017



Sweet Yuan

Certification Department

Nemko AS

Gaustadalléen 30, P.O. Box 73 Blindern, 0314 Oslo, Norway
TEL +47 22 96 03 30 FAX +47 22 96 05 50 EMAIL info@nemko.com
ENTERPRISE NUMBER NO974404532

Certificate



Intertek

for European Product Safety

Reference No. 1600036

Plug, non rewirable

Type designation	YP-22
Certificate holder	YUNG LI CO. LTD. DA PU INDUSTRIAL ZONE GANGZI CHANG PING TOWN DONGGUAN, 523571 GUANGDONG CHINA
The product complies with the standard(s)	IEC 60884-1:2002 + A1 + A2 SS 428 08 34:2013
Date of expiry	12 February 2021

Additional information in Appendix.

Certification Body Intertek Semko AB, Product Certification Place Kista - Stockholm

Signed

Bo Berglöf

Date 12 February 2016
Page 1 of 2

This certificate is issued in accordance with the terms and conditions set out in the Appendix.



**Intertek
Appendix**

Reference No. 1600036

Technical data

Type designation	YP-22
Rated voltage (V)	250~
Rated current (A)	16
IP-Class	20
Type of cord	H03VV-F 3G0,75mm ² H05VV-F 3G0,75-1,5mm ² H05RN-F 3G0,75-1,0mm ² H05V2V2-F 3G0,75-1,5mm ² H03V2V2-F 3G0,75mm ²
Standard sheet	CEE 7/VII
Trade mark	YUNG LI
Product information	Non rewirable plug for class I equipments. With angled cord entry.

This certificate replaces previously issued ref. No. 1312344 dated 2013-10-29 for YUNG LI CO. LTD. A new certificate has been issued on account of updating the standard.

The certificate applies for countries that have sanctioned the use of plugs/outlets according to subject standard sheet and component standard.

Manufacturing site(s) YUNG LI CO. LTD.
DA PU INDUSTRIAL ZONE
GANGZI CHANG PING TOWN
DONGGUAN, 523571 GUANGDONG
CHINA

Certification Body Intertek Semko AB, Product Certification *Place* Kista - Stockholm

Signed 
Bo Berglöf *Date* 12 February 2016

This Certificate is for the exclusive use of Intertek's Client and is provided pursuant to the Certification agreement between Intertek and its Client. Intertek's responsibility and liability are limited to the terms and conditions of the agreement. Intertek assumes no liability to any party, other than to the Client in accordance with the agreement, for any loss, expense or damage occasioned by the use of this certificate. Only the Client is authorized to permit copying or distribution of this certificate and then only in its entirety. Use of Intertek's Certification mark is restricted to the conditions laid out in the agreement. Any further use of the Intertek name for the sale or advertisement of the tested material, product or service must first be approved in writing by Intertek. Initial Factory Assessments and Follow up Services are for the purpose of assuring appropriate usage of the Certification mark in accordance with the agreement, they are not for the purposes of production quality control and do not relieve the Client of their obligations in this respect.

CERTIFICATE

Issued to:
Applicant:
Yung Li Co., Ltd.
Da Pu Industrial Zone, Chang Ping Town
523571 Dongguan City, China

Manufacturer/Licensee:
Yung Li Co., Ltd.
Da Pu Industrial Zone, Chang Ping Town
523571 Dongguan City, China

Product : plug, (2-pole)
Trade name : YUNG LI
Type/model : YP-22

The product and any acceptable variation thereto is specified in the Annex to this certificate and the documents therein referred to.

DEKRA hereby declares that the above-mentioned product has been certified on the basis of:

- a type test according to the standard IEC 60884-1:2002 + A1:2006 and NEN 1020:1987 + A2:2004
- an inspection of the production location according to CENELEC Operational Document CIG 021
- a certification agreement with the number 2078870

DEKRA hereby grants the right to use the KEMA-KEUR certification mark.

The KEMA-KEUR certification mark may be applied to the product as specified in this certificate for the duration of the KEMA-KEUR certification agreement and under the conditions of the KEMA-KEUR certification agreement.

This certificate is issued on 16 November 2012 and expires upon withdrawal of one of the above mentioned standards.

Certificate number: 2158219.01

DEKRA Certification B.V.



drs. G.J. Zoetbrood
Managing Director



H.R.M. Barends
Certification Manager

© Integral publication of this certificate is allowed

All testing, inspection, auditing and certification activities of the former KEMA Quality are an integral part of the DEKRA Certification Group.

ACCREDITED BY
THE DUTCH COUNCIL
FOR ACCREDITATION



SPECIFICATION OF THE CERTIFIED PRODUCT
Product data

product	: plug, (2-pole)
trade name	: YUNG LI
type	: YP-22, YP-22
rated current	: 16 A
rated voltage	: 250 V~
earthing	: with dual earthing contacts
design	: non-rewirable, angled
standard sheet	: VII
description	: body of thermoplastic material as part of a complete or incomplete cord set for class I appliances
markings	: are shown on the body

List of components

Component	trade name	type/model	approval mark ¹⁾
insert	GEM Terminal Ind. Co., Ltd.	98651A-VDE	*

¹⁾ * indicates a component tested as part of the appliance

Product data - type YP-22

applied flexible cords	: H05RR-F 3G1,5 mm ² H07RN-F 3G1,0 and 3G1,5 mm ²
certification mark	: complies with the specified requirements
cord termination	: crimped connection
design	: big cord guard

Product data - type YP-22

applied flexible cords	: H03VV-F 3G0,75 mm ² H03V2V2-F 3G0,75 mm ² H05VV-F 3G0,75, 3G1,0 and 3G1,5 mm ² H05V2V2-F 3G0,75, 3G1,0 and 3G1,5 mm ² H05RR-F 3G0,75 and 3G1,0 mm ² H05RN-F 3G0,75 and 3G1,0 mm ²
certification mark	: complies with the specified requirements
cord termination	: crimped connection
design	: small cord guard

TESTS
Test requirements

IEC 60884-1:2002 + A1:2006
NEN 1020:1987 + A2:2004

Test result

The test results are laid down in DEKRA test file 2158219.01.

Remarks

This certificate replaces our certificate 2026550.01 dated 2003-01-20 and is partly based on VDE CB Test Certificate DE1-42031 dated 2009-10-12.

Conclusion

The examination proved that all test requirements were met.

Tested by : VDE

Checked by : M.A.R. Bollen

**Factory locations**

Yung Li Co., Ltd.

Da Pu Industrial Zone, Chang Ping Town
523571 Dongguan City, China

LICENCE

No. 18291 replaces No.12989

Issued to:
 Applicant:
Yung Li Co. Ltd.
1F, No.10, Lane 235,
Pao-Chiao Road
Hsin-Tien, New Taipei, Taiwan

Licensee:
Yung Li Co. Ltd.
1F, No.10, Lane 235,
Pao-Chiao Road
Hsin-Tien, New Taipei, Taiwan



Product : plugs (2-pole) for household purposes
 Trade name(s) : YUNG-LI
 Type(s)/model(s) : YP-22

The product and any acceptable variation thereto is specified in the annex to this licence and the documents therein referred to.

SGS CEBEC hereby declares that the above-mentioned product has been certified on the basis of:

- a type test according to the standard specified in annex
- an inspection of the production location
- a certification agreement with the number 1031

SGS CEBEC hereby grants the right to use the CEBEC certification mark
 The CEBEC certification mark may be applied to the product as specified in this licence for the duration of the CEBEC certification agreement and under the conditions of the CEBEC certification agreement.

This licence is issued on: 26/03/2013

ir. C. Lana,
 Certification Manager

© Only integral publication of this certificate, including the annex, is allowed
 This certificate is only valid combined with the publication on the following web address: www.sgs.com/ee

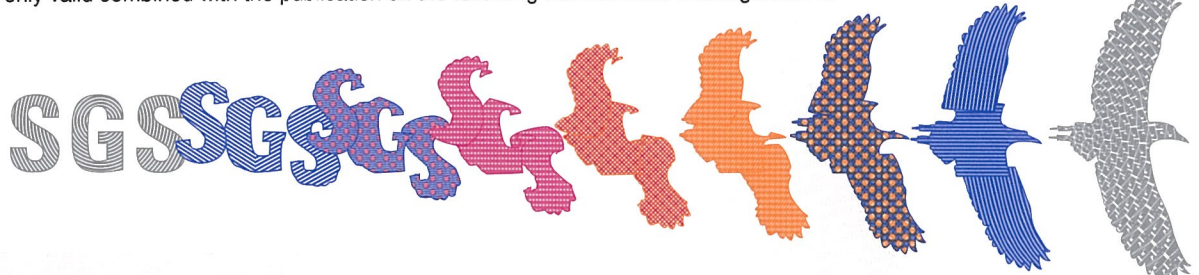

SPECIFICATION OF THE CERTIFIED PRODUCT

Product data

Product	:	plugs (2-pole) for household purposes
Trade name(s)	:	YUNG-LI
Type(s)/Model(s)	:	YP-22
rated current (In)	:	16 A
rated voltage (Un)	:	250 Vac
earthing	:	with dual earthing system
design	:	non-rewirable angled cable entry
class	:	for class I appliances
standard sheet	:	VII of CEE 7
applied flexible cord(s)	:	H03 VV-F 3G0.75 mm ² H05 VV-F 3G0.75-1.5 mm ² H03V2V2-F 3 G 0,75 mm ² H05V2V2-F 3 G 0,75-1.5 mm ²
description	:	body of thermoplastic material as part of an incomplete cord set for class I appliances
applied flexible cord(s) (cont'd)	:	H05RR-F 3 G 0,75-1,5 mm ² H05RN-F 3 G 0,75-1.0 mm ² H07RN-F 3 G 1,0-1,5 mm ²
cord(s) termination	:	crimped connection
certification mark	:	complies with the requirements
markings	:	are shown on the body

Additional information

Live part carriers: PBT, type 4115, black, Chang Chun Plastics.
Moulding: PVC, type Flex 60 O, all colours, Pure Friend Business Enterprise Corp.
Insert: GEM

TESTS

Test requirements

NBN C 61-112-1 based on IEC 60884-1:2002 + A1:2006

Test results

The test results are laid down in certification file ref.596812/01

Remarks

This certificate is based on certificate ref. CB DE1-42031 and test report(s) ref. 1609800-1560-0002/122934

Conclusion

The examination proved that all test requirements were met.

Checked by, project leader : Zanutto Luigi - 26/03/2013

Department Manager,
Product Certification :

Certification Manager :

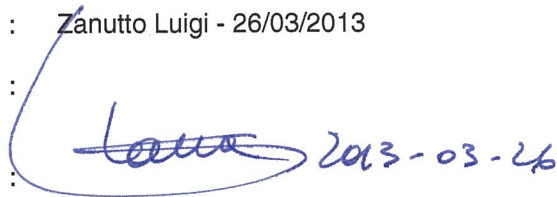
 2013-03-26

FACTORY LOCATION(S)

Yung Li Co., Ltd.
Da Pu Industrial Zone, GanZi
Chang Ping Town, Dong Guan City
523571 Guang Dong Province
China



CERTIFICATE NCS/FI 29581

Our Ref. 284214-1

Product Plug, non-rewirable

Type YP-22, with cord H03VV-F 3G0,75
 YP-22, with cord H03V2V2-F 3G0,75
 YP-22, with cord H05V2V2-F 3G0,75-1-1,5
 YP-22, with cord H05VV-F 3G0,75-1-1,5
 YP-22, with cord H05RN-F 3G0,75-1

Trade mark YUNG LI

**Certificate Holder/
 Manufacturer** Yung-Li Co., Ltd.
 Da Pu Industrial Zone, Gangzi Chang Ping Town
 Dongguan, 523571 GUANGDONG
 CHINA

Technical information 16 A, 250 V~, IP20

Other information Standard sheet CEE 7 / VII

The product is certified according to the following standard(s) IEC 60884-1:2002 (Ed 3) + A1:2006 + A2:2013
 SFS 5610:2015

Validity This certificate is valid until 13 June 2021 unless the standard in question has been amended or superseded with significant changes in requirements, in which case, SGS Fimko has the right to shorten the validity of the certificate based on the legislation of the European Union. This certificate includes the right to use the FI mark under the condition that changes (if any) will be checked at SGS Fimko before the product is brought onto market and that the conditions for FI certification are met.

Date of issue 13 June 2016

Signature **SGS Fimko Ltd**

Sixten Lökfors
 Project Manager



This certificate has 1 appendix



This certificate is issued by the company under its General Conditions for Certification Services accessible at <http://www.sgs.fi/en/Terms-and-Conditions.aspx>. Attention is drawn to the limitations of liability defined therein and in the Test Report here above mentioned which findings are reflected in this certificate. Any unauthorized alteration, forgery or falsification of the content or appearance of this document is unlawful and offenders may be prosecuted to the fullest extent of the law.

ЕВРАЗИЙСКИЙ ЭКОНОМИЧЕСКИЙ СОЮЗ



СЕРТИФИКАТ СООТВЕТСТВИЯ

№ ЕАЭС ВУ/112 02.01. 020 09041

Серия ВУ № 0007501

ОРГАН ПО СЕРТИФИКАЦИИ

Открытое акционерное общество «Испытания и сертификация бытовой и промышленной продукции «БЕЛЛИС»; место нахождения: Республика Беларусь, 220029, г. Минск, ул. Красная, 7Б; место осуществления деятельности: Республика Беларусь, 220029, г. Минск, ул. Красная, 8; аттестат аккредитации № ВУ/112.020.02 от 03.08.1993; номер телефона: +243 17 243 16 41; адрес электронной почты: bellis@bellis.by

ЗАЯВИТЕЛЬ

Yung Li Co., Ltd., Da Pu Industrial Zone, Chang Ping Town, Dong Guan City, Guangdong, 523571, Китай

номер телефона: +86-769-83335989; адрес электронной почты: eng@yung-li.com

ИЗГОТОВИТЕЛЬ

Yung Li Co., Ltd., Da Pu Industrial Zone, Chang Ping Town, Dong Guan City, Guangdong, 523571, Китай

ПРОДУКЦИЯ

Вилка штепсельная неразборная с заземляющим контактом «YUNG LI» модели УР-22, УР-23

серийный выпуск

КОД ТН ВЭД ЕАЭС 8544 42

СООТВЕТСТВУЕТ ТРЕБОВАНИЯМ

Технический регламент Таможенного союза «О безопасности низковольтного оборудования» ТР ТС 004/2011;

СЕРТИФИКАТ СООТВЕТСТВИЯ ВЫДАН НА ОСНОВАНИИ

протокола аккредитованной испытательной лаборатории «БЕЛЛИС», ВУ/112 1.0001, № 101-19-2255 от 26.09.2019,

отчета о проверке производства № 07-386/2019 от 26.09.2019

Схема сертификации: 1с

ДОПОЛНИТЕЛЬНАЯ ИНФОРМАЦИЯ ГОСТ ИЕС 60884-1-2013 Соединители электрические штепсельные бытового и аналогичного назначения. Часть 1. Общие требования и методы испытаний.

При поставках продукции на рынок стран ЕАЭС следует сообщить в орган по сертификации реквизиты компании-импортера (резидента страны ЕАЭС), которая является в соответствии с законодательством ответственной за качество поставляемой продукции, для дальнейшего включения этой информации в сертификат.

СРОК ДЕЙСТВИЯ С 30.09.2019 ПО 29.09.2024 ВКЛЮЧИТЕЛЬНО

Руководитель (уполномоченное лицо)
органа по сертификации

Эксперт (эксперт-аудитор)
(эксперты (эксперты- аудиторы))



Раковский
Александр Григорьевич
(Ф.И.О.)

Пепик
Ольга Иосифовна
(Ф.И.О.)

ZEICHENGENEHMIGUNG MARKS APPROVAL

Yung-Li Co. Ltd.
Da Pu Industrial Zone, Cang Zi
Chang Ping Town
523571 DONG GUAN CITY
Guangdong
CHINA

ist berechtigt, für ihr Produkt /
is authorized to use for their product

Gerätesteckdose, nicht-wiederanschließbar
Connector, non-rewirable

die hier abgebildeten markenrechtlich geschützten Zeichen
für die ab Blatt 2 aufgeführten Typen zu benutzen /
the legally protected Marks as shown below for the types referred to on page 2 ff.



Geprüft und zertifiziert nach /
Tested and certified according to

DIN EN 60320-1 (VDE 0625-1):2016-04; EN 60320-1:2015+AC:2016
DIN EN 60320-3 (VDE 0625-3):2015-11; EN 60320-3:2014
IEC 60320-1:2015
IEC 60320-3:2014



Aktenzeichen: 1609800-1550-0003 / 232784

File ref.:

Ausweis-Nr. 40029577

Blatt 1

Certificate No.

Page

Weitere Bedingungen siehe Rückseite und Folgeblätter /
further conditions see overleaf and following pages

Offenbach, 2010-03-05

(letzte Änderung/updated 2017-12-13)

VDE Prüf- und Zertifizierungsinstitut GmbH
VDE Testing and Certification Institute
Zertifizierungsstelle / Certification

G. Heine

VDE Zertifikate sind nur gültig bei Veröffentlichung unter:
VDE certificates are valid only when published on:

<http://www.vde.com/zertifikat>
<http://www.vde.com/certificate>

Name und Sitz des Genehmigungs-Inhabers / *Name and registered seat of the Certificate holder*

Yung-Li Co. Ltd., Da Pu Industrial Zone, Cang Zi, Chang Ping Town, 523571 DONG GUAN CITY, Guangdong, CHINA

Aktenzeichen / *File ref.*

1609800-1550-0003 / 232784 / TL3 / E

letzte Änderung / *updated*

2017-12-13

Datum / *Date*

2010-03-05

Dieses Blatt gilt nur in Verbindung mit Blatt 1 des Zeichengenehmigungsausweises Nr. 40029577.

This supplement is only valid in conjunction with page 1 of the Certificate No. 40029577.

Gerätesteckdose, nicht-wiederanschließbar *Connector, non-rewirable*

Typ(en) / *Type(s)*

- 1) YC-12
- 2) YC-12L

Bemessungsspannung
Rated voltage

AC 250 V

Bemessungsstrom
Rated current

10 A

Polzahl
Number of poles

2-polig mit Schutzkontakt
2-pole with earthing contact

Bauart
Kind of construction

Normblatt C13
standard sheet C13

Ausführung(en)
Construction(s)

zentrale Leitungseinführung
straight cable entry
Für / *for* 1)

abgewinkelte Leitungseinführung
angled cable entry
Für / *for* 2)

Warenzeicheninhaber
Trademark holder

Yung Li Co. Ltd.

Produktinformation

siehe Anlage Nr. 300 + 700 + 702 + 703 + 900 vom 2017-11-02
und
Anlage Nr. 701 vom 2017-12-13

Product information

*see Appendix No. 300 + 700 + 702 + 703 + 900 dated
2017-11-02
and
Appendix No. 701 dated 2017-12-13*

Fortsetzung siehe Blatt 3 /
continued on page 3

VDE Prüf- und Zertifizierungsinstitut Zeichengenehmigung

Ausweis-Nr. / Blatt /
Certificate No. / Page
40029577 3

Name und Sitz des Genehmigungs-Inhabers / *Name and registered seat of the Certificate holder*

Yung-Li Co. Ltd., Da Pu Industrial Zone, Cang Zi, Chang Ping Town, 523571 DONG GUAN CITY, Guangdong, CHINA

Aktenzeichen / *File ref.*

1609800-1550-0003 / 232784 / TL3 / E

letzte Änderung / *updated*

2017-12-13

Datum / *Date*

2010-03-05

Dieses Blatt gilt nur in Verbindung mit Blatt 1 des Zeichengenehmigungsausweises Nr. 40029577.

This supplement is only valid in conjunction with page 1 of the Certificate No. 40029577.

Dieser Zeichengenehmigungs-Ausweis bildet eine Grundlage für die EG-Konformitätserklärung und CE-Kennzeichnung durch den Hersteller oder dessen Bevollmächtigten und bescheinigt die Konformität mit den grundlegenden Schutzanforderungen der **EG-Niederspannungsrichtlinie 2014/35/EU**.

*This Marks Approval is a basis for the EC Declaration of Conformity and the CE Marking by the manufacturer or his agent and proves the conformity with the essential safety requirements of the **EC Low-Voltage Directive 2014/35/EU**.*

VDE Prüf- und Zertifizierungsinstitut GmbH

VDE Testing and Certification Institute

Fachgebiet TL3

Section TL3

VDE Prüf- und Zertifizierungsinstitut Zeichengenehmigung

Ausweis-Nr. / Beiblatt /
Certificate No. Supplement
40029577

Name und Sitz des Genehmigungs-Inhabers / *Name and registered seat of the Certificate holder*

Yung-Li Co. Ltd., Da Pu Industrial Zone, Cang Zi, Chang Ping Town, 523571 DONG GUAN CITY, Guangdong, CHINA

Aktenzeichen / *File ref.*

1609800-1550-0003 / 232784 / TL3 / E

letzte Änderung / *updated*

2017-12-13

Datum / *Date*

2010-03-05

Dieses Beiblatt ist Bestandteil des Zeichengenehmigungsausweises Nr. 40029577.

This supplement is part of the Certificate No. 40029577.

Gerätesteckdose, nicht-wiederanschließbar *Connector, non-rewirable*

Fertigungsstätte(n)

Place(s) of manufacture

Referenz/*Reference*

30008928

Yung-Li Co. Ltd.

Da Pu Industrial Zone, Cang Zi

Chang Ping Town

523571 DONG GUAN CITY

Guangdong

CHINA

VDE Prüf- und Zertifizierungsinstitut GmbH

VDE Testing and Certification Institute

Fachgebiet TL3

Section TL3



VDE Prüf- und Zertifizierungsinstitut Zeichengenehmigung

Ausweis-Nr. / Infoblatt /
Certificate No. Info sheet
40029577

Name und Sitz des Genehmigungs-Inhabers / Name and registered seat of the Certificate holder

Yung-Li Co. Ltd., Da Pu Industrial Zone, Cang Zi, Chang Ping Town, 523571 DONG GUAN CITY, Guangdong, CHINA

Aktenzeichen / File ref.

1609800-1550-0003 / 232784 / TL3 / E

letzte Änderung / updated

2017-12-13

Datum / Date

2010-03-05

Dieses Blatt gilt nur in Verbindung mit Blatt 1 des Zeichengenehmigungsausweises Nr. 40029577.

This supplement is only valid in conjunction with page 1 of the Certificate No. 40029577.

Genehmigung zum Benutzen des auf Seite 1 abgebildeten markenrechtlich geschützten Zeichens des VDE:

Grundlage für die Benutzung sind die Allgemeinen Geschäftsbedingungen (AGB) der VDE Prüf- und Zertifizierungsinstitut GmbH (www.vde.com\AGB-Institut). Das Recht zur Benutzung erstreckt sich nur auf die bezeichnete Firma mit den genannten Fertigungsstätten und die oben aufgeführten Produkte mit den zugeordneten Bezeichnungen. Die Fertigungsstätte muss so eingerichtet sein, dass eine gleichmäßige Herstellung der geprüften und zertifizierten Ausführung gewährleistet ist.

Die Genehmigung ist so lange gültig wie die VDE-Bestimmungen gelten, die der Zertifizierung zugrunde gelegen haben, sofern sie nicht auf Grund anderer Bedingungen aus der VDE Prüf- und Zertifizierungsordnung (PM102) zurückgezogen werden muss.

Der Gültigkeitszeitraum einer VDE-GS-Zeichengenehmigung kann auf Antrag verlängert werden. Bei gesetzlichen und / oder normativen Änderungen kann die VDE-GS-Zeichengenehmigung ihre Gültigkeit zu einem früheren als dem angegebenen Datum verlieren.

Produkte, die das Biozid Dimethylfumarat (DMF) enthalten, dürfen gemäß der Kommissionsentscheidung 2009/251/EG nicht mehr in den Verkehr gebracht oder auf dem Markt bereitgestellt werden.

Der VDE-Zeichengenehmigungsausweis wird ausschließlich auf der ersten Seite unterzeichnet.

Approval to use the legally protected Mark of the VDE as shown on the first page:

Basis for the use are the general terms and conditions of the VDE Testing and Certification Institute (www.vde.com\terms-institute). The right to use the mark is granted only to the mentioned company with the named places of manufacture and the listed products with the related type references. The place of manufacture shall be equipped in a way that a constant manufacturing of the certified construction is assured.

The approval is valid as long as the VDE specifications are in force, on which the certification is based on, unless it is withdrawn according to the VDE Testing and Certification Procedure (PM102E).

The validity period of a VDE-GS-Mark Approval may be prolonged on request. In case of changes in legal and / or normative requirements, the validity period of a VDE-GS-Mark Approval may be shortened.

Products containing the biocide dimethylfumarate (DMF) may not be marketed or made available on the EC market according to the Commission Decision 2009/251/EC.

The approval is solely signed on the first page.

Certificate Number: 22012

CERTIFICATE OF APPROVAL

ISSUED PURSUANT TO THE ELECTRICITY (CONSUMER SAFETY) ACT 2004

ISSUED TO:

Yung Li Co Ltd

CLASS OF ARTICLE:

Appliance Connector

DESCRIPTION OF ARTICLE:

Appliance Connector
(Non-rewirable, straight entry, Group 1, C13 appliance connector for cold conditions for Class I equipment integrally moulded to any <HAR> certified H05VV-F 3G1.00mm² or Australian approved three-core, 1.00mm², PVC insulated and sheathed ordinary duty circular flexible cord)
250V, ac, 10A

EXAMINED FOR COMPLIANCE WITH: AS/NZS 60320.1 : 2004

TYPE REFERENCE CODE: Type No. YC-12

APPROVAL MARK:

Each electrical article of the abovementioned type shall be marked with Approval Number NSW22012 or N14877 ;or
the Regulatory Compliance Mark (RCM) provided that the requirements of all relevant parts of AS/NZS 4417 applicable to the article are fulfilled.

DATE OF APPROVAL: 31 October 2006

This approval expires 31 October 2011 unless suspended, cancelled, renewed or extended.



for Commissioner for Fair Trading

ADDENDUM TO CERTIFICATE OF APPROVAL 22012

Particulars of Modification(s)

1. Type No. YC-12 alternatively moulded to any <HAR> certified H05VV-F 3G0.75mm² or Australian approved, three-core, 0.75mm², PVC insulated and sheathed ordinary duty circular flexible cord not exceeding two metres in length.
2. Type No. YP-32 being similar to original Type No. YC-12 except a Standard Sheet 'E' Interconnection Plug Connector (AS/NZS 60320.2.2) alternatively moulded to either:-
 - (a) Any <HAR> certified H05VV-F 3G1.00mm² or equivalent Australian approved flexible cord; or
 - (b) Any <HAR> certified H05VV-F 3G0.75mm² or equivalent Australian approved flexible cord not exceeding two metres in length.
3. Type No. YC-12 alternatively moulded to any <HAR> certified H05VV-F 3G1.5mm² or Australian approved three-core, 1.5mm², PVC insulated and sheathed ordinary duty circular flexible cord.

Approved: 31 October 2006



for Commissioner for Fair Trading



Fair
Trading

Ref: NSW22012/2

RENEWAL OF CERTIFICATE OF APPROVAL NSW22012

PARTICULARS OF RENEWAL

The approval of the original appliance connector Model YC-12 and approved modifications has been renewed.

The Approval expires on 31/10/2016 unless it is renewed, extended, suspended or cancelled.

A handwritten signature in black ink, appearing to be "D. J. ...".

For Commissioner for Fair Trading



Fair
Trading

Ref: NSW22012/3

RENEWAL OF CERTIFICATE OF APPROVAL: NSW22012

Particulars of Renewal

The approval of the original appliance connector Model YC-12 and approved modifications has been renewed for FIVE years.

The Approval expires on 31/10/2021 unless it is renewed, extended, suspended or cancelled.

For Commissioner for Fair Trading

ZEICHENGENEHMIGUNG MARKS APPROVAL

Yung-Li Co. Ltd.
Da Pu Industrial Zone, Cang Zi
Chang Ping Town
523571 DONG GUAN CITY
Guangdong
CHINA

ist berechtigt, für ihr Produkt /
is authorized to use for their product

Starkstromleitungen für allgemeine Anwendungen
- Flexible Leitungen
mit thermoplastischer PVC-Isolierung
Cables for general applications
- Flexible cables with
thermoplastic PVC insulation

die hier abgebildeten markenrechtlich geschützten Zeichen
für die ab Blatt 2 aufgeführten Typen zu benutzen /
the legally protected Marks as shown below for the types referred to on page 2 ff.

◁VDE▷ oder/or ◁▷⊠▷ oder/or  schwarz
black rot
red

Geprüft und zertifiziert nach /
Tested and certified according to

DIN EN 50525-2-11 (VDE 0285-525-2-11):2012-01; EN 50525-2-11:2011



Aktenzeichen: 1609800-5140-0005 / 211124

File ref.:

Ausweis-Nr. 40010145

Blatt 1

Certificate No.

Page

Weitere Bedingungen siehe Rückseite und Folgeblätter /
further conditions see overleaf and following pages

Offenbach, 2004-04-27

(letzte Änderung / updated 2015-05-26)

VDE Prüf- und Zertifizierungsinstitut GmbH
VDE Testing and Certification Institute
Zertifizierungsstelle / Certification

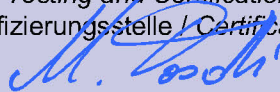

M. Tasotti

VDE Zertifikate sind nur gültig bei Veröffentlichung unter:
VDE certificates are valid only when published on:

<http://www.vde.com/zertifikat>
<http://www.vde.com/certificate>

Name und Sitz des Genehmigungs-Inhabers / *Name and registered seat of the Certificate holder*

Yung-Li Co. Ltd., Da Pu Industrial Zone, Cang Zi, Chang Ping Town, 523571 DONG GUAN CITY, Guangdong, CHINA

Aktenzeichen / *File ref.*

1609800-5140-0005 / 211124 / CC5 / HEG

letzte Änderung / *updated*

2015-05-26

Datum / *Date*

2004-04-27

Dieses Blatt gilt nur in Verbindung mit Blatt 1 des Zeichengenehmigungsausweises Nr. 40010145.

This supplement is only valid in conjunction with page 1 of the Certificate No. 40010145.

Starkstromleitungen für allgemeine Anwendungen - Flexible Leitungen mit thermoplastischer PVC-Isolierung *Cables for general applications - Flexible cables with thermoplastic PVC insulation*

Typ(en) / *Type(s)*

H03VV-F 2...4 x 0,5...0,75 mm ²	+
H03VVH2-F 2 x 0,5...0,75 mm ²	+
H05VV-F 2...5 x 0,75...4 mm ²	+
H05VVH2-F 2 x 0,75...1,0 mm ²	+

Leitungsbauart
Type of cable

Standardleitungen
General purpose cables

Firmenzeichen
Trademark

Yung Li Co., Ltd.

Dieser Zeichengenehmigungs-Ausweis bildet eine Grundlage für die EG-Konformitätserklärung und CE-Kennzeichnung durch den Hersteller oder dessen Bevollmächtigten und bescheinigt die Konformität mit den grundlegenden Schutzanforderungen der **EG-Niederspannungsrichtlinie 2006/95/EG** mit ihren Änderungen.
*This Marks Approval is a basis for the EC Declaration of Conformity and the CE Marking by the manufacturer or his agent and proves the conformity with the essential safety requirements of the **EC Low-Voltage Directive 2006/95/EC** including amendments.*

VDE Prüf- und Zertifizierungsinstitut GmbH
VDE Testing and Certification Institute
Fachgebiet CC5
Section CC5

Name und Sitz des Genehmigungs-Inhabers / *Name and registered seat of the Certificate holder*

Yung-Li Co. Ltd., Da Pu Industrial Zone, Cang Zi, Chang Ping Town, 523571 DONG GUAN CITY, Guangdong, CHINA

Aktenzeichen / *File ref.*

1609800-5140-0005 / 211124 / CC5 / HEG

letzte Änderung / *updated*

2015-05-26

Datum / *Date*

2004-04-27

Dieses Beiblatt ist Bestandteil des Zeichengenehmigungsausweises Nr. 40010145.

This supplement is part of the Certificate No. 40010145.

Starkstromleitungen für allgemeine Anwendungen
- Flexible Leitungen
mit thermoplastischer PVC-Isolierung
Cables for general applications
- Flexible cables with
thermoplastic PVC insulation

Fertigungsstätte(n)

Place(s) of manufacture

Referenz/*Reference*
30008928

Yung-Li Co. Ltd.
Da Pu Industrial Zone, Cang Zi
Chang Ping Town
523571 DONG GUAN CITY
Guangdong
CHINA

VDE Prüf- und Zertifizierungsinstitut GmbH
VDE Testing and Certification Institute
Fachgebiet CC5
Section CC5

Name und Sitz des Genehmigungs-Inhabers / *Name and registered seat of the Certificate holder*

Yung-Li Co. Ltd., Da Pu Industrial Zone, Cang Zi, Chang Ping Town, 523571 DONG GUAN CITY, Guangdong, CHINA

Aktenzeichen / *File ref.*

1609800-5140-0005 / 211124 / CC5 / HEG

letzte Änderung / *updated*

2015-05-26

Datum / *Date*

2004-04-27

Dieses Blatt gilt nur in Verbindung mit Blatt 1 des Zeichengenehmigungsausweises Nr. 40010145.

This supplement is only valid in conjunction with page 1 of the Certificate No. 40010145.

Genehmigung zum Benutzen des auf Seite 1 abgebildeten markenrechtlich geschützten Zeichens des VDE:

Grundlage für die Benutzung sind die Allgemeinen Geschäftsbedingungen (AGB) der VDE Prüf- und Zertifizierungsinstitut GmbH (www.vde.com\AGB-Institut). Das Recht zur Benutzung erstreckt sich nur auf die bezeichnete Firma mit den genannten Fertigungsstätten und die oben aufgeführten Produkte mit den zugeordneten Bezeichnungen. Die Fertigungsstätte muss so eingerichtet sein, dass eine gleichmäßige Herstellung der geprüften und zertifizierten Ausführung gewährleistet ist.

Die Genehmigung ist so lange gültig wie die VDE-Bestimmungen gelten, die der Zertifizierung zugrunde gelegen haben, sofern sie nicht auf Grund anderer Bedingungen aus der VDE Prüf- und Zertifizierungsordnung (PM102) zurückgezogen werden muss.

Der Gültigkeitszeitraum einer VDE-GS-Zeichengenehmigung kann auf Antrag verlängert werden. Bei gesetzlichen und / oder normativen Änderungen kann die VDE-GS-Zeichengenehmigung ihre Gültigkeit zu einem früheren als dem angegebenen Datum verlieren.

Produkte, die das Biozid Dimethylfumarat (DMF) enthalten, dürfen gemäß der Kommissionsentscheidung 2009/251/EG nicht mehr in den Verkehr gebracht oder auf dem Markt bereitgestellt werden.

Der VDE-Zeichengenehmigungsausweis wird ausschließlich auf der ersten Seite unterzeichnet.

Approval to use the legally protected Mark of the VDE as shown on the first page:

Basis for the use are the general terms and conditions of the VDE Testing and Certification Institute (www.vde.com\terms-institute). The right to use the mark is granted only to the mentioned company with the named places of manufacture and the listed products with the related type references. The place of manufacture shall be equipped in a way that a constant manufacturing of the certified construction is assured.

The approval is valid as long as the VDE specifications are in force, on which the certification is based on, unless it is withdrawn according to the VDE Testing and Certification Procedure (PM102E).

The validity period of a VDE-GS-Mark Approval may be prolonged on request. In case of changes in legal and / or normative requirements, the validity period of a VDE-GS-Mark Approval may be shortened.

Products containing the biocide dimethylfumarate (DMF) may not be marketed or made available on the EC market according to the Commission Decision 2009/251/EC.

The approval is solely signed on the first page.