

東莞永力電業有限公司

YUNG LI CO., LTD

Da Pu Industrial Zone, Gang Zi, Changping Town,
Dong Guan City, Guangdong 523571 China.P.R.C

TEL:0769-83396797~8

FAX:0769-83396796

E-mail: sales@yung-li.com

Description: YP-22/YC-18

Customer: MAG

Parts No. : CB-19

Draw No. :

REVISION RECORD

| | | |
|---|--|--|
| 1 | | |
| 2 | | |
| 3 | | |
| 4 | | |
| 5 | | |

| YUNG LI | |
|---------|-------------|
| CHECKED | PREPARED BY |
| | |

| CUSTOMER | APPROVED |
|----------|----------|
| | |

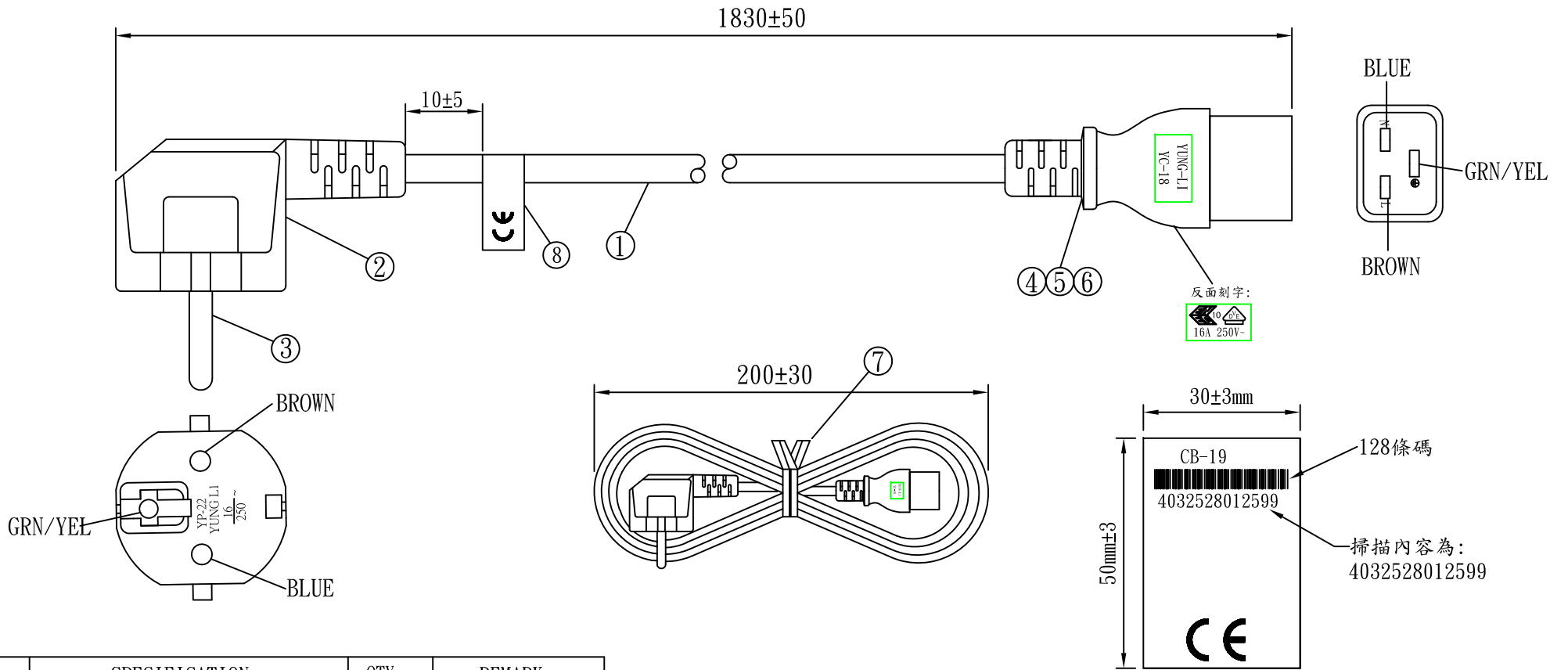

| NO. | SPECIFICATION | QTY | REMARK |
|-----|-----------------------------|--------|-------------|
| 1 | H05VV-F 1.0/3G BLACK | 1PC | 1810±20(YL) |
| 2 | YP-22 PVC PLASTIC:50P BLACK | 34g/PC | |
| 3 | TER:98651 BLACK | 1PC | |
| 4 | YC-18 PVC PLASTIC:50P BLACK | 25g/PC | |
| 5 | YC-18 INNER BODY | 1PC | |
| 6 | YC-18 TER | 3PCS | |
| 7 | MINI TIE:L=150mm BLACK | 1PC | |
| 8 | Cord Label:50*30mm 128Code | 1PC | |

| TOLERANCE >0±0.30 >1.0±0.50 >10.0±1.0 >20.0±2.0 Angle: ±1° | APPROVED | DATE | YUNG LI CO., LTD | | | | |
|------------------------------------------------------------------------------|-------------|------|------------------|----------|---------|------|----|
| | CHECKED | DATE | | | | | |
| DRAWN | SUKI | DATE | 18.10.25 | CUSTOMER | MAG | | |
| TYPE | YP-22/YC-18 | | P/N | CB-19 | | | |
| DRAWING NO. | CY-V0533-01 | REV | B | MATERIAL | P. V. C | UNIT | mm |
| SCALE | | | | | | | |



1532AP

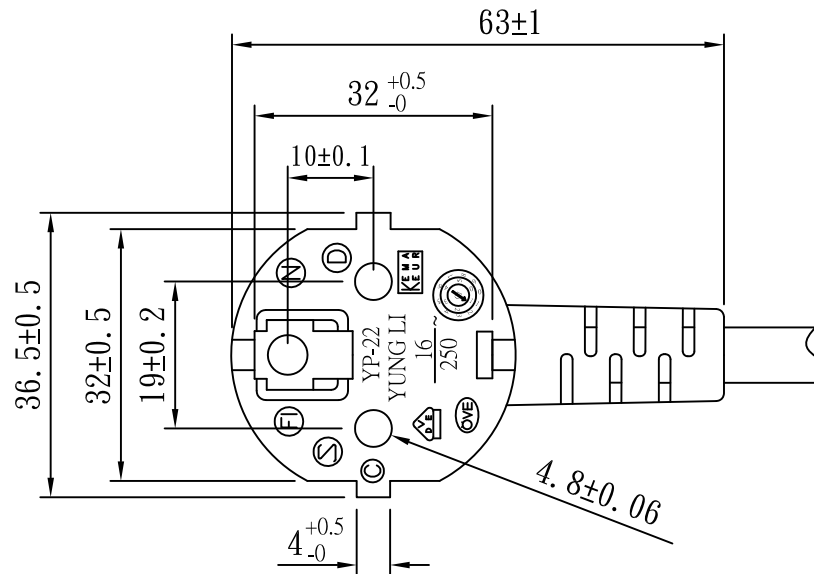
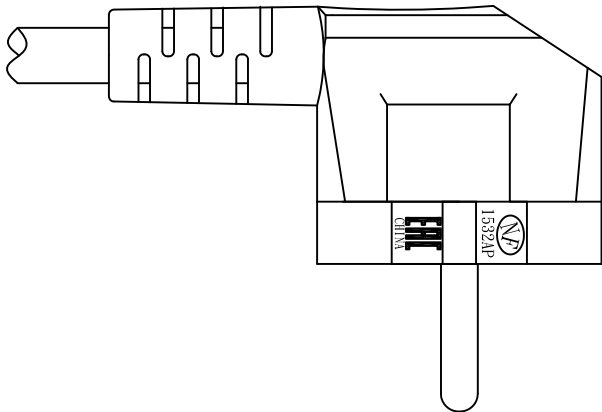
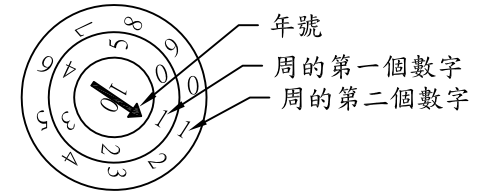
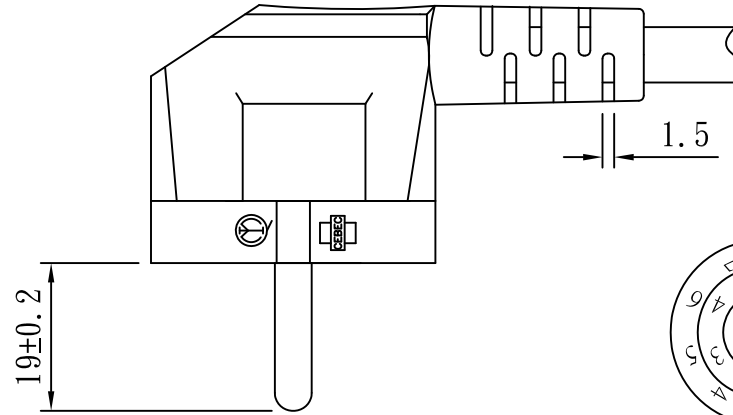
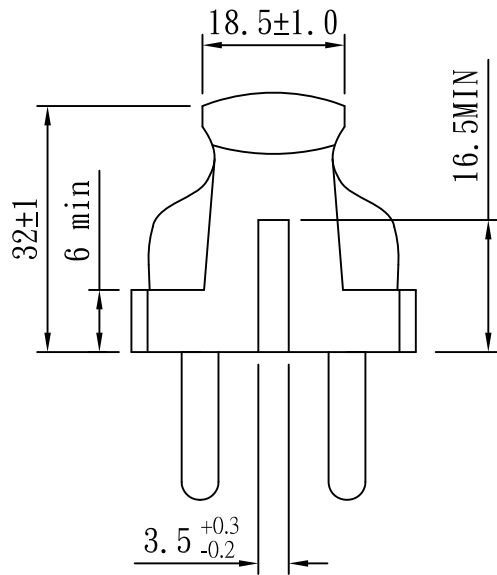

| | | | | | | | | |
|------------------------------------------------------------------------------|------------|-------|------|--|-------------------|-------|------|----|
| TOLERANCE >0±0.30 >1.0±0.50 >10.0±1.0 >20.0±2.0 Angle: ±1° | APPROVED | | DATE | | YUNG LI CO., LTD. | | | |
| | CHECKED | | DATE | | | | | |
| | DRAWN | | DATE | | | | | |
| | TYPE | YP-22 | | | P/N | | | |
| | DRAWING NO | | | | MATERIAL | P.V.C | UNIT | mm |
| | | | | | SCALE | 1:1 | | |



IEC 60320 C19

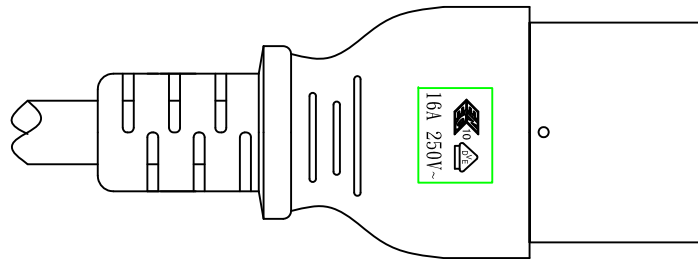
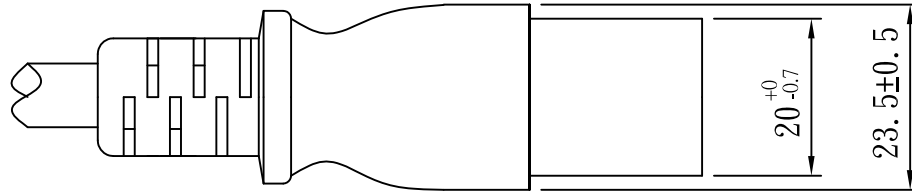
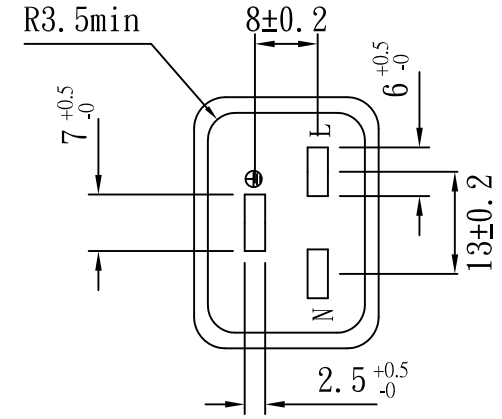
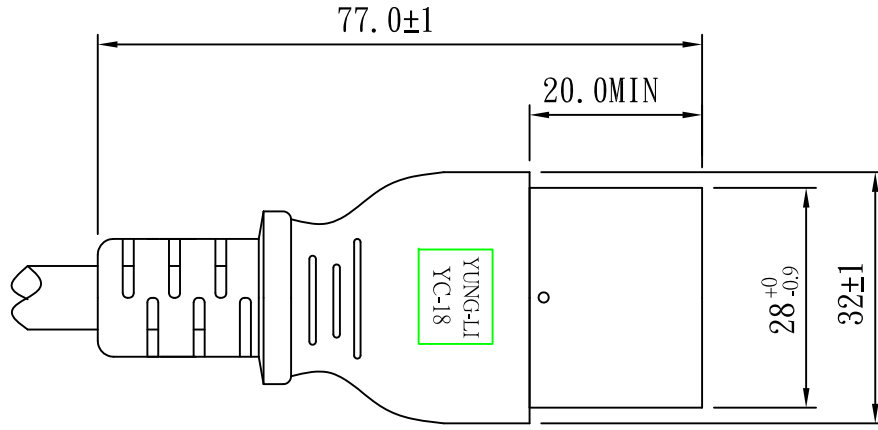

| | | | | | | | | |
|---------------------------------------------------------------------------|-------------|-------------|------|------------------------|----------|---------|------|----|
| Tolerance >0±0.30 >1.0±0.50 >10.0±1.0 >20.0±2.0 Angle: ±1° | Approved | | Date | YUNG LI CO.,LTD | | | | |
| | Checked | | Date | | | | | |
| | Drawn | | Date | Customer | | | | |
| | Cat. No. | YC-18(ENEC) | | | P/N. | | | |
| | Drawing No. | | Rev. | B | Material | P. V. C | Unit | mm |
| | | | | Scale | | | | |

YUNG LI CO., LTD

SPECIFICATION









| | | | |
|-----------|-------|-------------------------------------|-------------|
| Yung Li | Style | PVC FLEXIBLE CORDS | Document No |
| 2012.7.18 | | | YL-V01004 |
| Edition | Size | H05VV-F 3G 1.0mm² | Page |
| A | | | 1/2 |

1. Standard: IEC 60227 IEC 60228

2. Construction & Dimension

| | Item | Specification |
|---------------|--------------------------------|-------------------------|
| Conductor | Size | 3G 1.0mm ² |
| | Material | Annealed Bare Copper |
| | Construction | 32/ § 0.202±0.005 |
| Insulation | Material | PVC |
| | Minimum Average Thickness | 0.60mm |
| | Minimum Thickness at any point | 0.48mm |
| | Diameter | 2.50 ± 0.10 |
| | Identification | Blue,Brown,Yellow/Green |
| Core Assembly | Core Twist | 3-Core |
| | Filler | NA |
| | Assembly Pair | NA |
| Taping | Mylar Foil | NA |
| Shielded | A1-Mylar Foil | NA |
| Drain | Material | NA |
| | Construction | NA |
| Jacket | Material | NA |
| | Minimum Average Thickness | 0.8mm |
| | Minimum Thickness at any point | 0.58mm |
| | Overall Diameter(Approx) | 7.0± 0.15 |
| | Color | Any Color |

Marking:

Yung Li Co., Ltd. H05VV-F 3G 1.0mm² <VDE> NF-USE 1347  KEMA-KEUR  CEBEC <ÖVE>
     IEMMEQU ES0140750  A004049 60227 IEC 53(RVV) 300/500V  SU01027-4002

YUNG LI CO., LTD

SPECIFICATION

| | | | |
|-----------|-------|-------------------------------------|-------------|
| Yung Li | Style | PVC FLEXIBLE CORDS | Document No |
| 2012.7.18 | | | YL--V01004 |
| Edition | Size | H05VV-F 3G 1.0mm² | Page |
| A | | | 2/2 |

4. Electrical & Physical Properties

| Item | Specification | | |
|--------------------------------|-----------------------------|------------------------|------------------------------|
| Rating Voltage | 300/500V | | |
| Maximum Temperature Rating | 70°C | | |
| Conductor resistance(AT 20°C) | 19.5Ω/Km MAX | | |
| Insulation Resistance(AT 70°C) | 0.010MΩ · Km Min | | |
| Dielectric Strength | AC 2.0 KV / 15 min No Break | | |
| Spark Test | 5.0KV | | |
| Insulation | Unaged | Tensile Strength | 1.02 kgf/mm ² min |
| | | Elongation | 150% Min |
| | Aged | Tensile Strength | 80~120% (80°C x 168hrs) |
| | | Elongation | 80~120% (80°C x 168hrs) |
| | Loss of mass Test | | 2.0mg/cm ² (max) |
| Jacket | Unaged | Tensile Strength | 1.02 kgf/mm ² min |
| | | Elongation | 150% Min |
| | Aged | Tensile Strength | 80~120% (80°C x 168hrs) |
| | | Elongation | 80~120% (80°C x 168hrs) |
| | Loss of mass Test | | 2.0mg/cm ² (max) |
| Deformation Test | | 70±4°C X 1hr ≤ 50% | |
| Cold Bend Test | | -15°C x 4hr No Crack | |
| Heat Shock Test | | 150±2°C x 1hr No Crack | |

Graph:

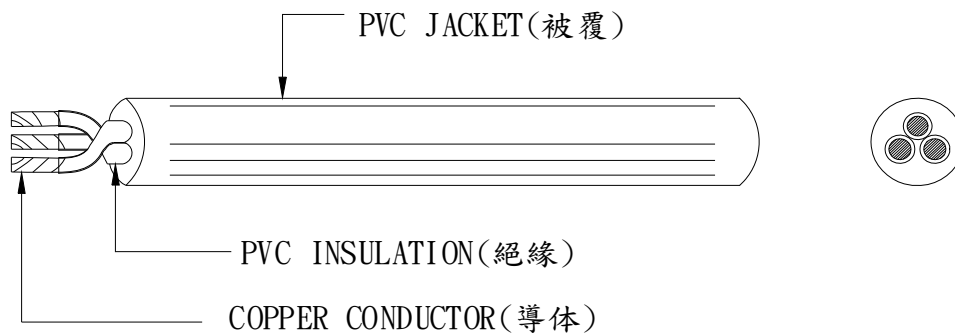

ZEICHENGENEHMIGUNG MARKS APPROVAL

Yung-Li Co. Ltd.
Da Pu Industrial Zone, Cang Zi
Chang Ping Town
523571 DONG GUAN CITY
Guangdong
CHINA

ist berechtigt, für ihr Produkt /
is authorized to use for their product

Stecker mit Schutzkontakt, nicht wiederanschließbar, umspritzt
Plug, with earthing contact, non-rewirable, moulded

die hier abgebildeten markenrechtlich geschützten Zeichen
für die ab Blatt 2 aufgeführten Typen zu benutzen /
the legally protected Marks as shown below for the types referred to on page 2 ff.



Geprüft und zertifiziert nach /
Tested and certified according to

DIN VDE 0620-2-1 (VDE 0620-2-1):2013-03



VDE Prüf- und Zertifizierungsinstitut GmbH
VDE Testing and Certification Institute
Zertifizierungsstelle / *Certification*

J. Gütermann
J. Gütermann

VDE Zertifikate sind nur gültig bei Veröffentlichung unter:
VDE certificates are valid only when published on:

Aktenzeichen: 1609800-1560-0002 / 178438
File ref.:

Ausweis-Nr. 40003878 Blatt 1
Certificate No. Page

Weitere Bedingungen siehe Rückseite und Folgeblätter /
further conditions see overleaf and following pages

Offenbach, 2002-11-04
(letzte Änderung/updated 2013-05-13)

<http://www.vde.com/zertifikat>
<http://www.vde.com/certificate>

Name und Sitz des Genehmigungs-Inhabers / *Name and registered seat of the Certificate holder*
Yung-Li Co. Ltd., Da Pu Industrial Zone, Cang Zi, Chang Ping Town, 523571 DONG GUAN CITY,
Guangdong, CHINA

Aktenzeichen / *File ref.*
1609800-1560-0002 / 178438 / CC1 / SHA

letzte Änderung / *updated* Datum / *Date*
2013-05-13 2002-11-04

Dieses Blatt gilt nur in Verbindung mit Blatt 1 des Zeichengenehmigungsausweises Nr. 40003878
This supplement is only valid in conjunction with page 1 of the Certificate No. 40003878.

Stecker mit Schutzkontakt, nicht wiederanschließbar, umspritzt
Plug, with earthing contact, non-rewirable, moulded

Typ(en) / *Type(s)*:

YP-22

| | |
|--------------------------------------------------|-------------------------------------------------------------------------------------------|
| Bemessungsspannung <i>Rated voltage</i> | AC 250 V |
| Bemessungsstrom <i>Rated current</i> | 16 A |
| Polzahl <i>Number of poles</i> | 2-polig mit zwei Schutzkontaktsystemen <i>2-pole with two earthing contact systems</i> |
| Bauart <i>Kind of construction</i> | DIN 49441-R2 |
| Schutzart <i>Degree of protection</i> | IP20 |
| Produktinformation <i>Product information</i> | siehe Anlage Nr. 400A + 401A + 900A <i>see Appendix No. 400A + 401A + 900A</i> |

VDE Prüf- und Zertifizierungsinstitut GmbH
VDE Testing and Certification Institute
Abteilung CC1
Section CC1

OVE AUSTRIAN ELECTROTECHNICAL ASSOCIATION

Eschenbachgasse 9, 1010 Wien, Austria
ZVR: 327279890 | DVR: 1055887



OVE - Testing & Certification

Kahlenberger Str. 2A, 1190 Wien, Austria
Phone: +43 1 370 58 06
www.ove.at

Page 1 of 2

ÖVE-CERTIFICATE

including the entitlement to use the Austrian Safety Mark



Certificate No.: **21721-006-05**

Valid from: 2017 02 17
until: 2019 02 17

The Austrian Electrotechnical Association (OVE) hereby grants the right to the company mentioned below to label the listed products with the Austrian Safety Mark.

Company: **Yung Li Co. Ltd.**
Da Pu Industrial Zone, Gang Zi, Chang Ping Town
523571 Dong Guan City, Guang Dong Province
China

Product: **Non rewirable two pole plug with dual earthing system**

The products submitted by the applicant were type tested in accordance with the requirements of the technical standards and specifications listed in this certificate. OVE certifies the conformity of the listed products and those products manufactured strictly identical to the submitted ones (ISO/IEC 17067, Conformity Assessment Scheme Type 5).

The manufacturing process and the products are subject to ongoing surveillance based on harmonized European procedures. This certificate has been issued under the presumption and conditional on the fact that the applicant holds all necessary legal rights with regard to the product, presented for the testing and certification.

Results of testing are shown in file No(s): **1740-1182/03**

Österreichischer Verband für Elektrotechnik
Head of Testing & Certification



Digitally signed by W. Martin
Email=w.martin@ove.at

Dipl.-Ing. W. Martin

Vienna, 2017 02 15

OVE - Testing & Certification

Accredited by the Federal Ministry of Science, Research and Economy as Certification Body for products within the scope as given in the official decree and published under www.en.bmwf.gv.at/accreditation



Manufacturer:

Yung Li Co. Ltd.
Da Pu Industrial Zone, Gang Zi, Chang Ping Town
523571 Dong Guan City, Guang Dong Province
China

Factory location(s):

Yung Li Co. Ltd.
Da Pu Industrial Zone, Gang Zi, Chang Ping Town
523571 Dong Guan City, Guang Dong Province
China

Tested and certified according to:

ÖVE/ÖNORM IEC 60884-1:2005-09-01

Product: Non rewirable two pole plug with dual earthing system

Type designation:
Rating:

Trademark:

YP-22

Rated voltage: AC 250 V
Rated current: 16 A
H03VV-F 3 G 0,75

YUNG LI

YP-22

Rated voltage: AC 250 V
Rated current: 16 A
H05VV-F 3 G 0,75

YUNG LI

YP-22

Rated voltage: AC 250 V
Rated current: 16 A
H05VV-F 3 G 1

YUNG LI

YP-22

Rated voltage: AC 250 V
Rated current: 16 A
H05VV-F 3 G 1,5

YUNG LI

OVE - Testing & Certification

Accredited by the Federal Ministry of Science, Research and Economy as Certification Body for products within the scope as given in the official decree and published under www.en.bmwf.gv.at/accreditation



LCIE

Accréditation
N°5-0014
Portée
disponible sur
www.cofrac.fr



LICENCE



LCIE N° 621358

Délivrée à:
Delivered to:

YUNG LI Co., Ltd
1F, No 10, Lane 235, Pao-Chiang Road, Hsin-Tien - TAIPEI - TAIWAN

Site de fabrication :
Factory:

YUNG LI Co., Ltd. (1532AP)
Da Pu Industrial Zone, Gang Zi, Chang Ping Town - Dong Guan City - GUANG DONG PROVINCE 523571 - CHINE

Produit:
Product:

Fiche de prise de courant
Plug

Marque commerciale (s'il y a lieu):
Trade mark (if any):

YUNG-LI

Modèle, type, référence:
Model, type, reference:

YP-22

Caractéristiques nominales et principales:
Rating and principal characteristics:

16A 250V~, 2P avec contact de terre/2P with dual earthing contact
voir annexe/see annex

Informations complémentaires:
Additional informations:

Mise à jour suite à évolution de la norme
update further to the evolution of the standard

Le produit est conforme à:
The product is in conformity with:

NF C 61-314:2008 +A1:2010

Documents pris en compte:
Relevant documents:

Rapport d'essai/test report n° BVCB11DE1038ACSP, certificat d'essai
OC/CB test certificate n° DE1-42031 / TR 1609800-1560-0002/122934

Annule et remplace (s'il y a lieu):
Cancel and replaces (if necessary):

Licence n°555296 du 2007-02-08

En vertu de la présente décision notifiée par le LCIE France organisme mandaté, AFNOR Certification accorde le droit d'usage de la Marque NF à la société qui en est titulaire pour les produits visés ci-dessus, dans les conditions définies par les règles générales de la Marque NF et par les règles de certification NF, pour autant que les contrôles réguliers de la fabrication et les vérifications par tierce partie soient satisfaisants.

On the strength of the present decision notified by LCIE France mandated certification body, AFNOR Certification grants the right to use the NF Mark to the licence holder for the above mentioned products, within the frame of the general rules of the NF Mark and of the NF certification rules, as far as the regular checking and third party verifications of the production are satisfactory.

Fontenay-aux-Roses, 2012-01-11

Michel BRENON

Date limite de validité :
Limit expired date :

Directeur de la Certification
Certification Manager

La validité de la présente licence cesse dès l'annulation de l'une des normes sur laquelle elle est fondée.
The present licence is valid until the cancellation of one of the standards on which it is based.

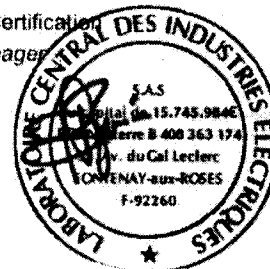

PID:
02113100
CID:
C.1996.5269

Certificato di approvazione

Approval certificate

IMQ, ente di certificazione accreditato, autorizza la ditta *IMQ, accredited certification body, grants to*

YUNG LI CO., LTD.
DA PU IND. ZONE, GangZi, CHANG PING TOWN
DONG GUAN CITY, GUANG DONG PROV.
CN - China

all'uso del marchio

the licence to use the mark

IMQ

Il presente certificato è soggetto alle condizioni previste nel "Regolamento IMQ - Certificazione prodotto" ed è relativo ai prodotti descritti nell'Allegato al presente certificato.



per i seguenti prodotti

for the following products

**Spine indissolubilmente
collegate al cavo
(Rif. di tipo YP-22)**

*Non-rewirable plugs
(Type ref. YP-22)*

This certificate is subjected to the conditions foreseen by "IMQ Rules - Product Certification" and is relevant to the products listed in the annex to this certificate.

Emesso il | Issued on **2003-04-17**
Aggiornato il | Updated on **2011-09-21**
Sostituisce | Replaces **2008-06-17**

IMQ S.p.A.

Allegato - Certificato di approvazione
Annex - Approval certificate

Emesso il / Issued on 2003-04-17
Aggiornato il / Updated on 2011-09-21
Sostituisce / Replaces 2008-06-17

Prodotto | Product

Spine indissolubilmente collegate al cavo
Non-rewirable plugs

Concessionario | Licence Holder

YUNG LI CO., LTD.
DA PU IND. ZONE, GangZi, CHANG PING TOWN
DONG GUAN CITY, GUANG DONG PROV.
CN - China

Marchio | Mark



IMQ

Costruito a | Manufactured at

PI.B000M3 C01175219

DONG GUAN CITY, GUANG DONG PROV.

China

Copia del presente certificato deve essere conservata presso i luoghi di produzione sopra elencati.

Copy of this certificate must be available at the manufacturing places listed above

Norme

CEI 23-50 - II Ed. 2007 + V1:2008

Standards

CEI 23-50 - II Ed. 2007 + V1:2008

Rapporti | Test Reports

26LL00072

Caratteristiche tecniche | Technical characteristics

Designazione | Type designation **2P+T+T S31 / 2P+E+E S31**
Tensione nominale | Rated voltage **250 V**
Corrente nominale | Rated current **16 A**
Grado di protezione | Degree of protection (IP) **IP20**
Tipo di morsetti | Type of terminals **morsetti aggraffati / crimped connections**
Materiale della custodia | Material of the cover **termoplastico / thermoplastic**
Uscita cavo | Cable exit **a squadra / angled**

Articoli (con dettagli) | Articles (with details)

AR.D0022W

Marca | Trade mark **YUNG-LI**
Riferimento di tipo | Type reference **YP-22**
Tipo di cavo | Type of cable **H03VV-F**
Sezione nominale | Section areas **3G0,75 mm²**

AR.D0022X

Marca | Trade mark **YUNG-LI**
Riferimento di tipo | Type reference **YP-22**
Tipo di cavo | Type of cable **H05VV-F**
Sezione nominale | Section areas **3G0,75 mm²**

AR.D0022Y

Marca | Trade mark **YUNG-LI**
Riferimento di tipo | Type reference **YP-22**
Tipo di cavo | Type of cable **H05VV-F**
Sezione nominale | Section areas **3G1 mm²**

AR.D0022Z

Marca / Trade mark **YUNG-LI**
Riferimento di tipo / Type reference **YP-22**
Tipo di cavo / Type of cable **H05VV-F**
Sezione nominale / Section areas **3G1,5 mm²**

Ulteriori informazioni | Additional Information

La spina rif. di tipo YP-22 è prodotta col seguente inserto:
marca: GEM ; art.: P98651.

The non-rewirable plug type ref. YP-23 is manufactured with the following insert:
trade mark: GEM; art.: P98651.

Componenti | Component List

Rif. di tipo/Type ref. YP-22

| Tipo / Type | (*) | Costruttore / Manufacturer | Riferimento / Type Ref. | Dati / Data | Norme / Standard (*) | Marchi / Marks |
|--------------|-----|----------------------------|-------------------------|-------------|----------------------|----------------|
| Cavo / Cable | 2/4 | YUNG LI | YUNG LI | H03VV-F | - | IMQ |
| Cavo / Cable | 2/4 | YUNG LI | YUNG LI | H05VV-F | - | IMQ |

Emesso il / Issued on **2008-06-17** Data di aggiornamento / Updated on **2011-09-21** Sostituisce / Replaces **2008-06-17**

Ciascun componente è contraddistinto da un numero avente il seguente significato:

- 1 - Componente marchiato e sostituibile con altro pure marchiato con caratteristiche equivalenti
- 2 - Componente sostituibile solo previa autorizzazione dell'IMQ
- 3 - Componente (integrato nell'apparecchio utilizzatore) provato congiuntamente all'apparecchio utilizzatore
- 4 - Componente in alternativa
- 5 - Componente per uso opzionale
- 6 - Componente da abbinare

Each component is signed by a number having the following meaning:

- 1 - Approved component replaceable with another one also approved with equivalent characteristics
- 2 - Component replaceable with IMQ authorization only
- 3 - Integrated component tested together with appliances
- 4 - Alternative component
- 5 - Component for optional use
- 6 - Component to be matched

(*) Queste colonne sono compilate a cura di IMQ / These columns are filled in by IMQ

Diritti di concessione | Annual Fees

SN.D000DL BTL.021100.DA19 Diritti modelli IMQ - 0211 - Prese, spine e connettori di uso domestico | IMQ models - 0211 - Plugs and appliance couplers for domestic purposes

1



IMQ S.p.A.

DEMKO CERTIFICATE

Certificate No. D-06167
Page 1/3
Date of Issue 2017-10-24

Certificate Holder Yung Li Co Ltd
7F-12 No 99 Sec 1 Xintai 5th Rd
Xizhi District
New Taipei, 22175 Taiwan

Manufacturer Yung Li Co Ltd
7F-12 No 99 Sec 1 Xintai 5th Rd
Xizhi District
New Taipei, 22175 Taiwan

Production site Yung Li Co Ltd
Da Pu Industrial Zone
Gangzi Chang Ping Town
Dongguan, 523571 Guangdong China

Certified Product Model Non-rewirable, Two-pole plug with dual earthing contacts
YP-22
Trademark YUNG LI

Rated Voltage / Frequency 250 V ~
Rated Current / Power 16 A
Insulation Class -
Degree of protection (IP) 20
Tested acc. to DS 60884-2-D1:2017
Test Report No. 4788152169 issued on 2017-10-24
Additional This certificate replaces the earlier issued certificate No.D-05356
Expire date 2026-06-12

Certification Manager
Jan-Erik Storgaard

This is to certify that representative sample(s) of the Product described herein ("Certified Product") have been investigated and found in compliance with the Standard(s) indicated on this Certificate, in accordance with the D Mark Requirements. The Designated Certificate holder is entitled to use the d or for cables <DEMKO> for the Certified Product manufactured at the production site(s) identified above, in accordance with the D Mark Service Agreement, including without limitation the D Mark Testing and Certification Services Service Terms. Only those Products bearing the D Mark should be considered as being covered by UL's D Mark Service. This Certificate shall remain valid through the expiration date, unless terminated earlier in accordance with the Service Agreement including without limitation if the Standard identified on this Certificate is amended or withdrawn prior the expiration date.

Certification Body

UL International Demko A/S, Borupvang 5A, DK-2750
Ballerup, Denmark, Tel. +45 44 85 65 65, info.dk@ul.com
www.ul-europe.com



Appendix DEMKO CERTIFICATE

Certificate No. D-06167
Page 2/3
Date of Issue 2017-10-24

External Certification Information:
FI 9308, issued on 2016-06-13 by SGS Fimko Ltd

Additional Information:
For class I equipment
Standard Sheet:
C4 (DS 60884-2-D1)
VII (CEE 7)

Flexible Cord:
YP-22 with H03VV-F 3G0.75 mm²
YP-22 with H05VV-F 3G0.75-1.0-1.5 mm²
YP-22 with H03V2V2-F 3G0.75 mm²
YP-22 with H05V2V2-F 3G0.75-1.0-1.5 mm²
YP-22 with H05RN-F 3G0.75-1.0 mm²

Certification Body

UL International Demko A/S, Borupvang 5A, DK-2750
Ballerup, Denmark, Tel. +45 44 85 65 65, info.dk@ul.com
www.ul-europe.com



Appendix DEMKO CERTIFICATE

Certificate No. D-06167
Page 3/3
Date of Issue 2017-10-24

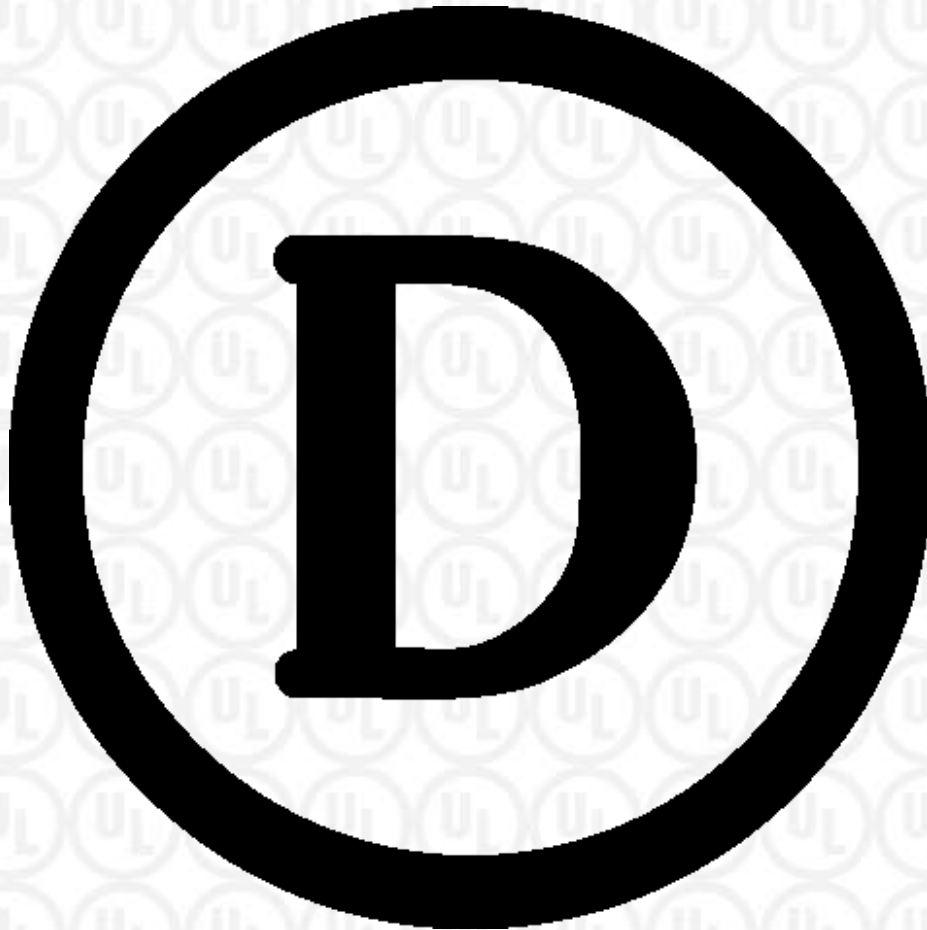

Certification Body

UL International Demko A/S, Borupvang 5A, DK-2750
Ballerup, Denmark, Tel. +45 44 85 65 65, info.dk@ul.com
www.ul-europe.com



| | |
|--------------------------------------------------------------------------|----------------------------------------------------------------------------------------------------------------------------------------------------------------------------------------------------------------------------------------------------------------------------------------------------------------------------------------------------------------------------------------------------------------------------------------------------------------------------------------------------------------------------|
| Product | Plugs |
| Applicant | Yung Li Co., Ltd. China Da Pu Industrial Zone, Chang Ping Town, Dong Guan City, Guangdong Province 523571 China |
| Manufacturer | Yung Li Co., Ltd. China Da Pu Industrial Zone, Chang Ping Town, Dong Guan City, Guangdong Province 523571 China |
| Factory | Yung Li Co., Ltd. China Da Pu Industrial Zone, Chang Ping Town, Dong Guan City, Guangdong Province 523571 China |
| Ratings | 16A 250V AC |
| Trade mark | YUNG LI |
| Model / Type Ref. | YP-22 |
| Principal characteristics | Non-rewirable plug, Standard Sheet VII, with H03VV-F 3G0.75mm ² |
| A sample of the product was tested and found to be in conformity with | INST IEC 60884-1:2002, IEC 60884-1:2002/AMD1:2006, IEC 60884-1:2002/AMD2:2013 NEK 502:2016 |
| Validity | This certificate documents conformity with the standards shown, and also applies as license for use of Nemkos name and certification mark. The certificate and license is valid as long as the applicable conditions are complied with, and provided that any changes to the product are notified to Nemko for acceptance prior to implementation. New standards or amendments to the standards may imply that the product design must be updated and/or that re-testing and re-certification is necessary. |
| Additional information | |
| Additional model(s) | (4) See page 2 |

Date of issue 01-03-2017



Sweet Yuan

Certification Department

Nemko AS

Gaustadalléen 30, P.O. Box 73 Blindern, 0314 Oslo, Norway
TEL +47 22 96 03 30 FAX +47 22 96 05 50 EMAIL info@nemko.com
ENTERPRISE NUMBER NO974404532

Additional model(s)

| | |
|---------------------------------------|-----------------------------------------------------------------------------------|
| Product | Plugs |
| Pos. No | 1 |
| Model / Type Ref. | YP-22 |
| Trade mark (if different from page 1) | |
| Rating | 16A 250V AC |
| Principal characteristics | Non-rewirable plug, Standard Sheet VII, with H05VV-F 3G0.75-1-1.5mm ² |
| Product | Plugs |
| Pos. No | 2 |
| Model / Type Ref. | YP-22 |
| Trade mark (if different from page 1) | |
| Rating | 16A 250V AC |
| Principal characteristics | Non-rewirable plug, Standard Sheet VII, with H03V2V2-F 3G0.75mm ² |
| Product | Plugs |
| Pos. No | 3 |
| Model / Type Ref. | YP-22 |
| Trade mark (if different from page 1) | |
| Rating | 16A 250V AC |
| Principal characteristics | Non-rewirable plug, Standard Sheet VII, with H05V2V2-F 3G0.7-1-1,5mm ² |
| Product | Plugs |
| Pos. No | 4 |
| Model / Type Ref. | YP-22 |
| Trade mark (if different from page 1) | |
| Rating | 16A 250V AC |
| Principal characteristics | Non-rewirable plug, Standard Sheet VII, with H05RN 3G0.75-1mm ² |

Date of issue 01-03-2017



Sweet Yuan

Certification Department

Nemko AS

Gaustadalléen 30, P.O. Box 73 Blindern, 0314 Oslo, Norway
TEL +47 22 96 03 30 FAX +47 22 96 05 50 EMAIL info@nemko.com
ENTERPRISE NUMBER NO974404532

Certificate



Intertek

for European Product Safety

Reference No. 1600036

Plug, non rewirable

| | |
|-------------------------------------------|-----------------------------------------------------------------------------------------------------------------------|
| Type designation | YP-22 |
| Certificate holder | YUNG LI CO. LTD. DA PU INDUSTRIAL ZONE GANGZI CHANG PING TOWN DONGGUAN, 523571 GUANGDONG CHINA |
| The product complies with the standard(s) | IEC 60884-1:2002 + A1 + A2 SS 428 08 34:2013 |
| Date of expiry | 12 February 2021 |

Additional information in Appendix.

Certification Body Intertek Semko AB, Product Certification Place Kista - Stockholm

Signed 
Bo Berglöf Date 12 February 2016
Page 1 of 2

This certificate is issued in accordance with the terms and conditions set out in the Appendix.



Intertek Appendix

Reference No. 1600036

Technical data

| | |
|---------------------|-----------------------------------------------------------------------------------------------------------------------------------------------------------------------------------|
| Type designation | YP-22 |
| Rated voltage (V) | 250~ |
| Rated current (A) | 16 |
| IP-Class | 20 |
| Type of cord | H03VV-F 3G0,75mm ² H05VV-F 3G0,75-1,5mm ² H05RN-F 3G0,75-1,0mm ² H05V2V2-F 3G0,75-1,5mm ² H03V2V2-F 3G0,75mm ² |
| Standard sheet | CEE 7/VII |
| Trade mark | YUNG LI |
| Product information | Non rewirable plug for class I equipments. With angled cord entry. |

This certificate replaces previously issued ref. No. 1312344 dated 2013-10-29 for YUNG LI CO. LTD. A new certificate has been issued on account of updating the standard.

The certificate applies for countries that have sanctioned the use of plugs/outlets according to subject standard sheet and component standard.

Manufacturing site(s) YUNG LI CO. LTD.
DA PU INDUSTRIAL ZONE
GANGZI CHANG PING TOWN
DONGGUAN, 523571 GUANGDONG
CHINA

Certification Body Intertek Semko AB, Product Certification Place Kista - Stockholm

Signed 
Bo Berglöf Date 12 February 2016

This Certificate is for the exclusive use of Intertek's Client and is provided pursuant to the Certification agreement between Intertek and its Client. Intertek's responsibility and liability are limited to the terms and conditions of the agreement. Intertek assumes no liability to any party, other than to the Client in accordance with the agreement, for any loss, expense or damage occasioned by the use of this certificate. Only the Client is authorized to permit copying or distribution of this certificate and then only in its entirety. Use of Intertek's Certification mark is restricted to the conditions laid out in the agreement. Any further use of the Intertek name for the sale or advertisement of the tested material, product or service must first be approved in writing by Intertek. Initial Factory Assessments and Follow up Services are for the purpose of assuring appropriate usage of the Certification mark in accordance with the agreement, they are not for the purposes of production quality control and do not relieve the Client of their obligations in this respect.

Handwritten mark

CERTIFICATE

Issued to:
Applicant:
Yung Li Co., Ltd.
Da Pu Industrial Zone, Chang Ping Town
523571 Dongguan City, China

Manufacturer/Licensee:
Yung Li Co., Ltd.
Da Pu Industrial Zone, Chang Ping Town
523571 Dongguan City, China

Product : plug, (2-pole)
Trade name : YUNG LI
Type/model : YP-22

The product and any acceptable variation thereto is specified in the Annex to this certificate and the documents therein referred to.

DEKRA hereby declares that the above-mentioned product has been certified on the basis of:

- a type test according to the standard IEC 60884-1:2002 + A1:2006 and NEN 1020:1987 + A2:2004
- an inspection of the production location according to CENELEC Operational Document CIG 021
- a certification agreement with the number 2078870

DEKRA hereby grants the right to use the KEMA-KEUR certification mark.

The KEMA-KEUR certification mark may be applied to the product as specified in this certificate for the duration of the KEMA-KEUR certification agreement and under the conditions of the KEMA-KEUR certification agreement.

This certificate is issued on 16 November 2012 and expires upon withdrawal of one of the above mentioned standards.

Certificate number: 2158219.01

DEKRA Certification B.V.



drs. G.J. Zoetbrood
Managing Director



H.R.M. Barends
Certification Manager

© Integral publication of this certificate is allowed

All testing, inspection, auditing and certification activities of the former KEMA Quality are an integral part of the DEKRA Certification Group.

ACCREDITED BY
THE DUTCH COUNCIL
FOR ACCREDITATION



SPECIFICATION OF THE CERTIFIED PRODUCT
Product data

| | |
|----------------|------------------------------------------------------------------------------------------------------|
| product | : plug, (2-pole) |
| trade name | : YUNG LI |
| type | : YP-22, YP-22 |
| rated current | : 16 A |
| rated voltage | : 250 V~ |
| earthing | : with dual earthing contacts |
| design | : non-rewirable, angled |
| standard sheet | : VII |
| description | : body of thermoplastic material as part of a complete or incomplete cord set for class I appliances |
| markings | : are shown on the body |

List of components

| Component | trade name | type/model | approval mark ¹⁾ |
|-----------|-----------------------------|------------|-----------------------------|
| insert | GEM Terminal Ind. Co., Ltd. | 98651A-VDE | * |

¹⁾ * indicates a component tested as part of the appliance

Product data - type YP-22

| | |
|------------------------|----------------------------------------------------------------------------|
| applied flexible cords | : H05RR-F 3G1,5 mm ² H07RN-F 3G1,0 and 3G1,5 mm ² |
| certification mark | : complies with the specified requirements |
| cord termination | : crimped connection |
| design | : big cord guard |

Product data - type YP-22

| | |
|------------------------|----------------------------------------------------------------------------------------------------------------------------------------------------------------------------------------------------------------------------------------------------------------------|
| applied flexible cords | : H03VV-F 3G0,75 mm ² H03V2V2-F 3G0,75 mm ² H05VV-F 3G0,75, 3G1,0 and 3G1,5 mm ² H05V2V2-F 3G0,75, 3G1,0 and 3G1,5 mm ² H05RR-F 3G0,75 and 3G1,0 mm ² H05RN-F 3G0,75 and 3G1,0 mm ² |
| certification mark | : complies with the specified requirements |
| cord termination | : crimped connection |
| design | : small cord guard |

TESTS
Test requirements

IEC 60884-1:2002 + A1:2006

NEN 1020:1987 + A2:2004

Test result

The test results are laid down in DEKRA test file 2158219.01.

Remarks

This certificate replaces our certificate 2026550.01 dated 2003-01-20 and is partly based on VDE CB Test Certificate DE1-42031 dated 2009-10-12.

Conclusion

The examination proved that all test requirements were met.

Tested by : VDE

Checked by : M.A.R. Bollen

**Factory locations**

Yung Li Co., Ltd.

Da Pu Industrial Zone, Chang Ping Town
523571 Dongguan City, China

LICENCE

No. 18291 replaces No.12989

Issued to:
 Applicant:
Yung Li Co. Ltd.
1F, No.10, Lane 235,
Pao-Chiao Road
Hsin-Tien, New Taipei, Taiwan

Licensee:
Yung Li Co. Ltd.
1F, No.10, Lane 235,
Pao-Chiao Road
Hsin-Tien, New Taipei, Taiwan



Product : plugs (2-pole) for household purposes
 Trade name(s) : YUNG-LI
 Type(s)/model(s) : YP-22

The product and any acceptable variation thereto is specified in the annex to this licence and the documents therein referred to.

SGS CEBEC hereby declares that the above-mentioned product has been certified on the basis of:

- a type test according to the standard specified in annex
- an inspection of the production location
- a certification agreement with the number 1031

SGS CEBEC hereby grants the right to use the CEBEC certification mark
 The CEBEC certification mark may be applied to the product as specified in this licence for the duration of the CEBEC certification agreement and under the conditions of the CEBEC certification agreement.

This licence is issued on: 26/03/2013

ir. C. Lana,
 Certification Manager

© Only integral publication of this certificate, including the annex, is allowed
 This certificate is only valid combined with the publication on the following web address: www.sgs.com/ee

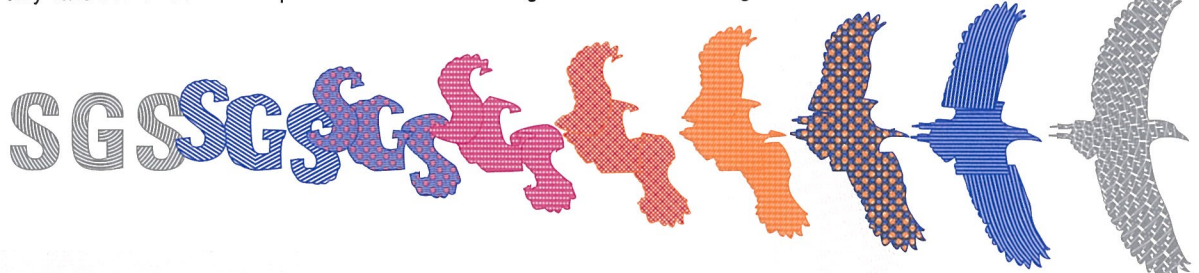

SPECIFICATION OF THE CERTIFIED PRODUCT

Product data

| | | |
|-----------------------------------|---|--------------------------------------------------------------------------------------------------------------------------------------------------------|
| Product | : | plugs (2-pole) for household purposes |
| Trade name(s) | : | YUNG-LI |
| Type(s)/Model(s) | : | YP-22 |
| rated current (In) | : | 16 A |
| rated voltage (Un) | : | 250 Vac |
| earthing | : | with dual earthing system |
| design | : | non-rewirable angled cable entry |
| class | : | for class I appliances |
| standard sheet | : | VII of CEE 7 |
| applied flexible cord(s) | : | H03 VV-F 3G0.75 mm ² H05 VV-F 3G0.75-1.5 mm ² H03V2V2-F 3 G 0,75 mm ² H05V2V2-F 3 G 0,75-1.5 mm ² |
| description | : | body of thermoplastic material as part of an incomplete cord set for class I appliances |
| applied flexible cord(s) (cont'd) | : | H05RR-F 3 G 0,75-1,5 mm ² H05RN-F 3 G 0,75-1.0 mm ² H07RN-F 3 G 1,0-1,5 mm ² |
| cord(s) termination | : | crimped connection |
| certification mark | : | complies with the requirements |
| markings | : | are shown on the body |

Additional information

Live part carriers: PBT, type 4115, black, Chang Chun Plastics.
Moulding: PVC, type Flex 60 O, all colours, Pure Friend Business Enterprise Corp.
Insert: GEM

TESTS

Test requirements

NBN C 61-112-1 based on IEC 60884-1:2002 + A1:2006

Test results

The test results are laid down in certification file ref.596812/01

Remarks

This certificate is based on certificate ref. CB DE1-42031 and test report(s) ref. 1609800-1560-0002/122934

Conclusion

The examination proved that all test requirements were met.

Checked by, project leader : Zanutto Luigi - 26/03/2013

Department Manager,
Product Certification :

Certification Manager :

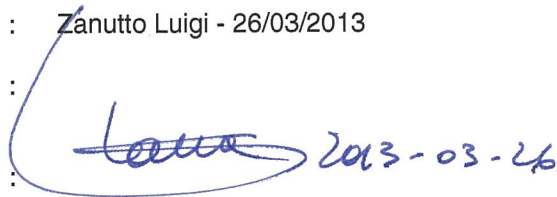

Zanutto 2013-03-26

FACTORY LOCATION(S)

Yung Li Co., Ltd.
Da Pu Industrial Zone, GanZi
Chang Ping Town, Dong Guan City
523571 Guang Dong Province
China



CERTIFICATE NCS/FI 29581

Our Ref. 284214-1

Product Plug, non-rewirable

Type YP-22, with cord H03VV-F 3G0,75
 YP-22, with cord H03V2V2-F 3G0,75
 YP-22, with cord H05V2V2-F 3G0,75-1-1,5
 YP-22, with cord H05VV-F 3G0,75-1-1,5
 YP-22, with cord H05RN-F 3G0,75-1

Trade mark YUNG LI

**Certificate Holder/
 Manufacturer** Yung-Li Co., Ltd.
 Da Pu Industrial Zone, Gangzi Chang Ping Town
 Dongguan, 523571 GUANGDONG
 CHINA

Technical information 16 A, 250 V~, IP20

Other information Standard sheet CEE 7 / VII

The product is certified according to the following standard(s) IEC 60884-1:2002 (Ed 3) + A1:2006 + A2:2013
 SFS 5610:2015

Validity This certificate is valid until 13 June 2021 unless the standard in question has been amended or superseded with significant changes in requirements, in which case, SGS Fimko has the right to shorten the validity of the certificate based on the legislation of the European Union. This certificate includes the right to use the FI mark under the condition that changes (if any) will be checked at SGS Fimko before the product is brought onto market and that the conditions for FI certification are met.

Date of issue 13 June 2016

Signature **SGS Fimko Ltd**

Sixten Lökfors
 Project Manager



This certificate has 1 appendix



This certificate is issued by the company under its General Conditions for Certification Services accessible at <http://www.sgs.fi/en/Terms-and-Conditions.aspx>. Attention is drawn to the limitations of liability defined therein and in the Test Report here above mentioned which findings are reflected in this certificate. Any unauthorized alteration, forgery or falsification of the content or appearance of this document is unlawful and offenders may be prosecuted to the fullest extent of the law.

**СЕРТИФИКАТ СООТВЕТСТВИЯ**№ ТС BY/112 02.01. 020 03965Серия ВУ № **0038757****ОРГАН ПО СЕРТИФИКАЦИИ**

Открытое акционерное общество «Испытания и сертификация бытовой и промышленной продукции «БЕЛЛИС»;
 юридический адрес: Республика Беларусь, 220029, г. Минск, ул. Красная, 7Б;
 фактический адрес: Республика Беларусь, 220029, г. Минск, ул. Красная, 8; телефон: +375 17 288 16 41;
 факс: +375 17 288 16 41; e-mail: bellis@bellis.by; аттестат аккредитации № ВУ/112.020.02 от 22.03.2011,
 Республиканское унитарное предприятие «Белорусский государственный центр аккредитации».

ЗАЯВИТЕЛЬ

YUNG LI CO., LTD.,
 юридический адрес: Da Pu Industrial Zone, Chang Ping Town, Dong Guan City, Guangdong, 523571, Китай;
 фактический адрес: Da Pu Industrial Zone, Chang Ping Town, Dong Guan City, Guangdong, 523571, Китай;
 телефон: + 8676983335989; факс: + 8676983396796; e-mail: eng@yung-li.com

ИЗГОТОВИТЕЛЬ

YUNG LI CO., LTD., Da Pu Industrial Zone, Chang Ping Town, Dong Guan City, Guangdong, 523571, Китай

ПРОДУКЦИЯ

Вилка (non-rewirable two pole plug (16A) with earthing contacts) YUNG LI модель YP-22

серийный выпуск

8544 42 290 0

КОД ТН ВЭД ТС**СООТВЕТСТВУЕТ ТРЕБОВАНИЯМ**

Технический регламент Таможенного союза «О безопасности низковольтного оборудования»
 ТР ТС 004/2011; ГОСТ Р 51322.1-2011

СЕРТИФИКАТ ВЫДАН НА ОСНОВАНИИ

протокола аккредитованной испытательной лаборатории «БЕЛЛИС», ВУ/112 02.1.0.0001,
 №№ 101-14-2649 от 22.12.2014;
 отчета о проверке производства от 05.11.2014.

ДОПОЛНИТЕЛЬНАЯ ИНФОРМАЦИЯСРОК ДЕЙСТВИЯ С 23.12.2014 ПО 22.12.2019

Руководитель (уполномоченное
лицо) органа по сертификации
Эксперт-аудитор (эксперт)

(Signature)
подпись
(Signature)
подпись

А.Г. Раковский
инициалы, фамилия

А.В. Сиводед
инициалы, фамилия

ZEICHENGENEHMIGUNG MARKS APPROVAL

Yung-Li Co. Ltd.
Da Pu Industrial Zone, Cang Zi
Chang Ping Town
523571 DONG GUAN CITY
Guangdong
CHINA

ist berechtigt, für ihr Produkt /
is authorized to use for their product

Gerätesteckdose, nicht-wiederanschließbar
Connector, non-rewirable

die hier abgebildeten markenrechtlich geschützten Zeichen
für die ab Blatt 2 aufgeführten Typen zu benutzen /
the legally protected Marks as shown below for the types referred to on page 2 ff.

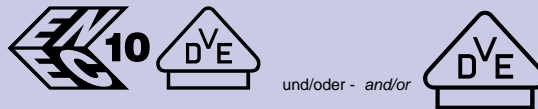

Geprüft und zertifiziert nach /
Tested and certified according to

DIN EN 60320-1 (VDE 0625-1):2016-04; EN 60320-1:2015 + AC:2016
IEC 60320-1:2015

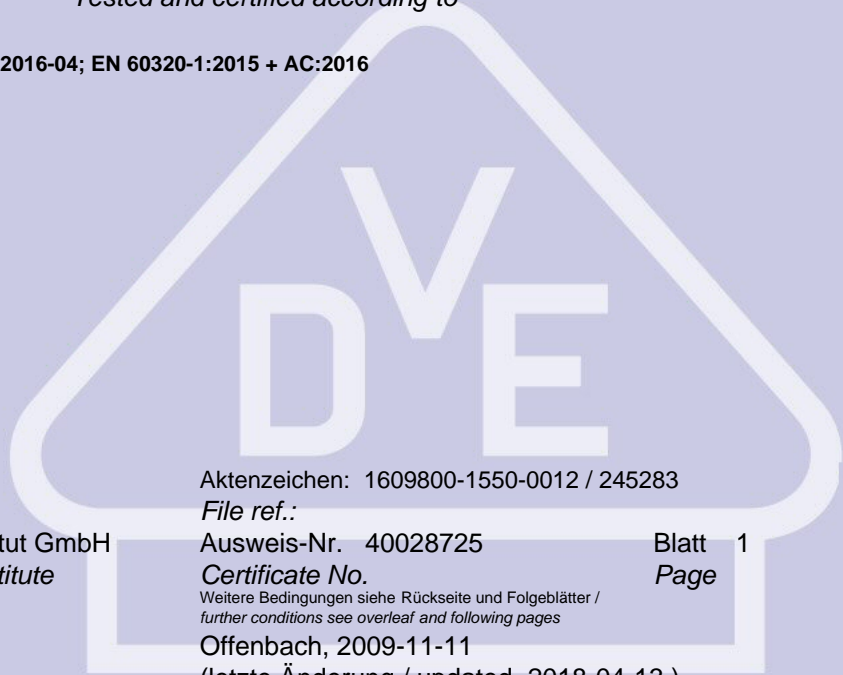

Aktenzeichen: 1609800-1550-0012 / 245283

File ref.:

Ausweis-Nr. 40028725

Blatt 1

Certificate No.

Page

Weitere Bedingungen siehe Rückseite und Folgeblätter /
further conditions see overleaf and following pages

Offenbach, 2009-11-11

(letzte Änderung / updated 2018-04-13)

VDE Prüf- und Zertifizierungsinstitut GmbH
VDE Testing and Certification Institute
Zertifizierungsstelle / Certification

R. Nickel

VDE Zertifikate sind nur gültig bei Veröffentlichung unter:
VDE certificates are valid only when published on:

<http://www.vde.com/zertifikat>
<http://www.vde.com/certificate>

Name und Sitz des Genehmigungs-Inhabers / *Name and registered seat of the Certificate holder*

Yung-Li Co. Ltd., Da Pu Industrial Zone, Cang Zi, Chang Ping Town, 523571 DONG GUAN CITY, Guangdong, CHINA

Aktenzeichen / *File ref.*

1609800-1550-0012 / 245283 / TL3 / E

letzte Änderung / *updated*

2018-04-13

Datum / *Date*

2009-11-11

Dieses Blatt gilt nur in Verbindung mit Blatt 1 des Zeichengenehmigungsausweises Nr. 40028725.

This supplement is only valid in conjunction with page 1 of the Certificate No. 40028725.

Gerätesteckdose, nicht-wiederanschließbar *Connector, non-rewirable*

Typ(en) / *Type(s)*

- 1) **YC-18**
- 2) **YC-18L**

Bemessungsspannung
Rated voltage

AC 250 V

Bemessungsstrom
Rated current

16 A

Polzahl
Number of poles

2-polig mit Schutzkontakt
2-pole with earthing contact

Bauart
Kind of construction

Normblatt C19
standard sheet C19

Ausführung(en)
Construction(s)

zentrale Leitungseinführung
straight cable entry
Für / *for* 1)

abgewinkelte Leitungseinführung
angled cable entry
Für / *for* 2)

Warenzeicheninhaber
Trademark holder

Yung-Li Co. Ltd.

Fortsetzung siehe Blatt 3 /
continued on page 3

VDE Prüf- und Zertifizierungsinstitut Zeichengenehmigung

Ausweis-Nr. / Blatt /
Certificate No. / Page
40028725 / 3

Name und Sitz des Genehmigungs-Inhabers / *Name and registered seat of the Certificate holder*

Yung-Li Co. Ltd., Da Pu Industrial Zone, Cang Zi, Chang Ping Town, 523571 DONG GUAN CITY, Guangdong, CHINA

Aktenzeichen / *File ref.*

1609800-1550-0012 / 245283 / TL3 / E

letzte Änderung / *updated*

2018-04-13

Datum / *Date*

2009-11-11

Dieses Blatt gilt nur in Verbindung mit Blatt 1 des Zeichengenehmigungsausweises Nr. 40028725.

This supplement is only valid in conjunction with page 1 of the Certificate No. 40028725.

Produktinformation
Product information

siehe Anlage Nr. 300 + 301 + 700 + 900 vom 2018-04-13
see Appendix No. 300 + 301 + 700 + 900 dated 2018-04-13

Dieser Zeichengenehmigungs-Ausweis bildet eine Grundlage für die EG-Konformitätserklärung und CE-Kennzeichnung durch den Hersteller oder dessen Bevollmächtigten und bescheinigt die Konformität mit den grundlegenden Schutzanforderungen der **EG-Niederspannungsrichtlinie 2014/35/EU**.

*This Marks Approval is a basis for the EC Declaration of Conformity and the CE Marking by the manufacturer or his agent and proves the conformity with the essential safety requirements of the **EC Low-Voltage Directive 2014/35/EU**.*

VDE Prüf- und Zertifizierungsinstitut GmbH
VDE Testing and Certification Institute
Fachgebiet TL3
Section TL3

VDE Prüf- und Zertifizierungsinstitut Zeichengenehmigung

Ausweis-Nr. / Beiblatt /
Certificate No. Supplement
40028725

Name und Sitz des Genehmigungs-Inhabers / *Name and registered seat of the Certificate holder*

Yung-Li Co. Ltd., Da Pu Industrial Zone, Cang Zi, Chang Ping Town, 523571 DONG GUAN CITY, Guangdong, CHINA

Aktenzeichen / *File ref.*

1609800-1550-0012 / 245283 / TL3 / E

letzte Änderung / *updated*

2018-04-13

Datum / *Date*

2009-11-11

Dieses Beiblatt ist Bestandteil des Zeichengenehmigungsausweises Nr. 40028725.

This supplement is part of the Certificate No. 40028725.

Gerätesteckdose, nicht-wiederanschließbar *Connector, non-rewirable*

Fertigungsstätte(n)

Place(s) of manufacture

Referenz/*Reference*

30008928

Yung-Li Co. Ltd.

Da Pu Industrial Zone, Cang Zi

Chang Ping Town

523571 DONG GUAN CITY

Guangdong

CHINA

VDE Prüf- und Zertifizierungsinstitut GmbH

VDE Testing and Certification Institute

Fachgebiet TL3

Section TL3



Name und Sitz des Genehmigungs-Inhabers / Name and registered seat of the Certificate holder

Yung-Li Co. Ltd., Da Pu Industrial Zone, Cang Zi, Chang Ping Town, 523571 DONG GUAN CITY, Guangdong, CHINA

Aktenzeichen / File ref.

1609800-1550-0012 / 245283 / TL3 / E

letzte Änderung / updated

2018-04-13

Datum / Date

2009-11-11

Dieses Blatt gilt nur in Verbindung mit Blatt 1 des Zeichengenehmigungsausweises Nr. 40028725.

This supplement is only valid in conjunction with page 1 of the Certificate No. 40028725.

Genehmigung zum Benutzen des auf Seite 1 abgebildeten markenrechtlich geschützten Zeichens des VDE:

Grundlage für die Benutzung sind die Allgemeinen Geschäftsbedingungen (AGB) der VDE Prüf- und Zertifizierungsinstitut GmbH (www.vde.com\AGB-Institut). Das Recht zur Benutzung erstreckt sich nur auf die bezeichnete Firma mit den genannten Fertigungsstätten und die oben aufgeführten Produkte mit den zugeordneten Bezeichnungen. Die Fertigungsstätte muss so eingerichtet sein, dass eine gleichmäßige Herstellung der geprüften und zertifizierten Ausführung gewährleistet ist.

Die Genehmigung ist so lange gültig wie die VDE-Bestimmungen gelten, die der Zertifizierung zugrunde gelegen haben, sofern sie nicht auf Grund anderer Bedingungen aus der VDE Prüf- und Zertifizierungsordnung (PM102) zurückgezogen werden muss.

Der Gültigkeitszeitraum einer VDE-GS-Zeichengenehmigung kann auf Antrag verlängert werden. Bei gesetzlichen und / oder normativen Änderungen kann die VDE-GS-Zeichengenehmigung ihre Gültigkeit zu einem früheren als dem angegebenen Datum verlieren.

Produkte, die das Biozid Dimethylfumarat (DMF) enthalten, dürfen gemäß der Kommissionsentscheidung 2009/251/EG nicht mehr in den Verkehr gebracht oder auf dem Markt bereitgestellt werden.

Der VDE-Zeichengenehmigungsausweis wird ausschließlich auf der ersten Seite unterzeichnet.

Approval to use the legally protected Mark of the VDE as shown on the first page:

Basis for the use are the general terms and conditions of the VDE Testing and Certification Institute (www.vde.com\terms-institute). The right to use the mark is granted only to the mentioned company with the named places of manufacture and the listed products with the related type references. The place of manufacture shall be equipped in a way that a constant manufacturing of the certified construction is assured.

The approval is valid as long as the VDE specifications are in force, on which the certification is based on, unless it is withdrawn according to the VDE Testing and Certification Procedure (PM102E).

The validity period of a VDE-GS-Mark Approval may be prolonged on request. In case of changes in legal and / or normative requirements, the validity period of a VDE-GS-Mark Approval may be shortened.

Products containing the biocide dimethylfumarate (DMF) may not be marketed or made available on the EC market according to the Commission Decision 2009/251/EC.

The approval is solely signed on the first page.

VDE Prüf- und Zertifizierungsinstitut GmbH

Aktenzeichen: **1609800-1550-0012/185134**
 File reference:

Ausweis-Nr.: **40028725**
 Certificate No.:

Anlage Nr.: **300**
 Appendix No.:

Seite: **1 / 1**
 Page:

Datum: **2013-08-28**
 Date:

Diese Anlage ist Bestandteil des Genehmigungsausweises. *This appendix is part of the certificate.*

| | | |
|-------------------------------------------------------------------------------------|-------------------------------------------------------------------------|-------------------------------------------------------------------|
| Gerätesteckdose, nicht-wiederanschließbar <i>Connector, non-rewirable</i> | 2-polig mit Schutzkontakt <i>2-pole with earthing contact</i> | zentrale Leitungseinführung <i>straight cable entry</i> |
|-------------------------------------------------------------------------------------|-------------------------------------------------------------------------|-------------------------------------------------------------------|

| | |
|-------------------------------------------------|--------------------------------------------------------------------------|
| Fertigungsstätte / Place of manufacture: | 30008928 : Kennzeichnung / Identification : ohne / without |
|-------------------------------------------------|--------------------------------------------------------------------------|

| Position im VDE-Ausweis <i>Position in VDE-licence</i> | Typ(en) <i>Type(s)</i> | Leitungsaufdruck <i>Marking on cable</i> | X \triangle genehmigte Ausführung / approved version | | | | | | | | | | --- \triangle nicht genehmigt / not approved | | | | | | | | | | |
|-----------------------------------------------------------|---------------------------|---------------------------------------------|--------------------------------------------------------|--------------------------------|-------------------------------------------|--------------------------------|-------------------------------------------|-------------------------------------------|--------------------------------|---------------------------------------------|----------------------------------|---|------------------------------------------------|----|----|----|----|----|----|----|----|----|----|
| | | | H05VV-F 3G 1,0 mm ² (max. 2 m) | H05VV-F 3G 1,5 mm ² | H05RR-F 3G 1,0 mm ² (max. 2 m) | H05RR-F 3G 1,5 mm ² | H05RN-F 3G 1,0 mm ² (max. 2 m) | H07RN-F 3G 1,0 mm ² (max. 2 m) | H07RN-F 3G 1,5 mm ² | H05V2V2-F 3G 1,0 mm ² (max. 2 m) | H05V2V2-F 3G 1,5 mm ² | | | | | | | | | | | | |
| YC-18 | | Yung Li | X | X | -- | -- | -- | -- | -- | -- | X | X | -- | -- | -- | -- | -- | -- | -- | -- | -- | -- | -- |

ZEICHENGENEHMIGUNG MARKS APPROVAL

Yung-Li Co. Ltd.
Da Pu Industrial Zone, Cang Zi
Chang Ping Town
523571 DONG GUAN CITY
Guangdong
CHINA

ist berechtigt, für ihr Produkt /
is authorized to use for their product

Starkstromleitungen für allgemeine Anwendungen
- Flexible Leitungen
mit thermoplastischer PVC-Isolierung
Cables for general applications
- Flexible cables with
thermoplastic PVC insulation

die hier abgebildeten markenrechtlich geschützten Zeichen
für die ab Blatt 2 aufgeführten Typen zu benutzen /
the legally protected Marks as shown below for the types referred to on page 2 ff.



oder/or



oder/or



schwarz
black

rot
red

Geprüft und zertifiziert nach /
Tested and certified according to

DIN EN 50525-2-11 (VDE 0285-525-2-11):2012-01; EN 50525-2-11:2011

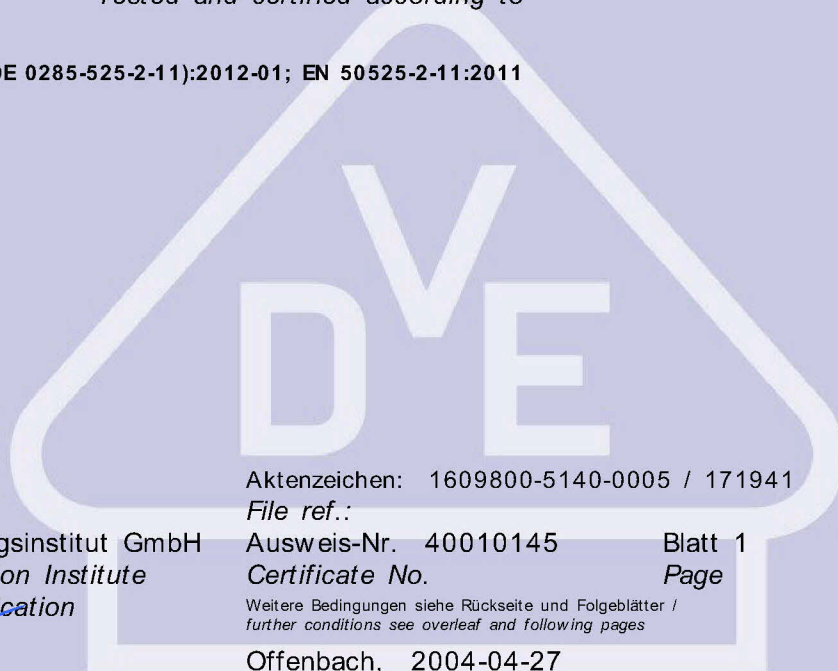

VDE Prüf- und Zertifizierungsinstitut GmbH
VDE Testing and Certification Institute
Zertifizierungsstelle / *Certification*

K. Prohaska

VDE Zertifikate sind nur gültig bei Veröffentlichung unter:
VDE certificates are valid only when published on:

Aktenzeichen: 1609800-5140-0005 / 171941
File ref.:

Ausweis-Nr. 40010145 Blatt 1
Certificate No. Page

Weitere Bedingungen siehe Rückseite und Folgeblätter /
further conditions see overleaf and following pages

Offenbach, 2004-04-27
(letzte Änderung/updated 2012-09-25)

<http://www.vde.com/zertifikat>
<http://www.vde.com/certificate>

Name und Sitz des Genehmigungs-Inhabers / *Name and registered seat of the Certificate holder*
Yung-Li Co. Ltd., Da Pu Industrial Zone, Cang Zi, Chang Ping Town, 523571 DONG GUAN CITY,
Guangdong, CHINA

Aktenzeichen / *File ref.*
1609800-5140-0005 / 171941 / FG42 / HEG

letzte Änderung / *updated* Datum / *Date*
2012-09-25 2004-04-27

Dieses Blatt gilt nur in Verbindung mit Blatt 1 des Zeichengenehmigungsausweises Nr. 40010145
This supplement is only valid in conjunction with page 1 of the Certificate No. 40010145.

Starkstromleitungen für allgemeine Anwendungen
- Flexible Leitungen
mit thermoplastischer PVC-Isolierung
Cables for general applications
- Flexible cables with
thermoplastic PVC insulation

Typ(en) / *Type(s)*:

| | |
|--------------------------------------------|---|
| H03VV-F 2...4 x 0,5...0,75 mm ² | + |
| H03VVH2-F 2 x 0,5...0,75 mm ² | + |
| H05VV-F 2...5 x 0,75...4 mm ² | + |
| H05VVH2-F 2 x 0,75...1,0 mm ² | + |

| | |
|----------------------------------------|----------------------------------------------------|
| Leitungsbauart <i>Type of cable</i> | Standardleitungen <i>General purpose cables</i> |
|----------------------------------------|----------------------------------------------------|

| | |
|-----------------------------------|---------|
| Firmenzeichen <i>Trademark</i> | YUNG LI |
|-----------------------------------|---------|

Dieser Zeichengenehmigungs-Ausweis bildet eine Grundlage für die EG-Konformitätserklärung und CE-Kennzeichnung durch den Hersteller oder dessen Bevollmächtigten und bescheinigt die Konformität mit den grundlegenden Schutzanforderungen der **EG-Niederspannungsrichtlinie 2006/95/EG** mit ihren Änderungen.

This Marks Approval is a basis for the EC Declaration of Conformity and the CE Marking by the manufacturer or his agent and proves the conformity with the essential safety requirements of the EC Low-Voltage Directive 2006/95/EC including amendments.

VDE Prüf- und Zertifizierungsinstitut GmbH
VDE Testing and Certification Institute
Fachgebiet FG42
Section FG42

Name und Sitz des Genehmigungs-Inhabers / *Name and registered seat of the Certificate holder*
Yung-Li Co. Ltd., Da Pu Industrial Zone, Cang Zi, Chang Ping Town, 523571 DONG GUAN CITY,
Guangdong, CHINA

Aktenzeichen / *File ref.*
1609800-5140-0005 / 171941 / FG42 / HEG

letzte Änderung / *updated* Datum / *Date*
2012-09-25 2004-04-27

Dieses Beiblatt ist Bestandteil des Zeichengenehmigungsausweises Nr. 40010145.
This supplement is part of the Certificate No. 40010145.

Starkstromleitungen für allgemeine Anwendungen
- Flexible Leitungen
mit thermoplastischer PVC-Isolierung
Cables for general applications
- Flexible cables with
thermoplastic PVC insulation

Fertigungsstätte(n)
Place(s) of manufacture

Referenz/*Reference* Yung-Li Co. Ltd.
30008928 Da Pu Industrial Zone, Cang Zi
 Chang Ping Town
 523571 DONG GUAN CITY
 Guangdong
 CHINA

VDE Prüf- und Zertifizierungsinstitut GmbH
VDE Testing and Certification Institute
Fachgebiet FG42
Section FG42

VDE Prüf- und Zertifizierungsinstitut

Zeichengenehmigung

Ausweis-Nr. / Infoblatt /
Certificate No. Info sheet
40010145

Name und Sitz des Genehmigungs-Inhabers / *Name and registered seat of the Certificate holder*

Yung-Li Co. Ltd., Da Pu Industrial Zone, Cang Zi, Chang Ping Town, 523571 DONG GUAN CITY,
Guangdong, CHINA

Aktenzeichen / *File ref.*

1609800-5140-0005 / 171941 / FG42 / HEG

letzte Änderung / *updated* Datum / *Date*

2012-09-25 2004-04-27

Dieses Blatt gilt nur in Verbindung mit Blatt 1 des Zeichengenehmigungsausweises Nr. 40010145

This supplement is only valid in conjunction with page 1 of the Certificate No. 40010145.

Genehmigung zum Benutzen des auf Seite 1 abgebildeten markenrechtlich geschützten Zeichens des VDE:

Grundlage für die Benutzung sind die Allgemeinen Geschäftsbedingungen (AGB) der VDE Prüf- und Zertifizierungsinstitut GmbH (www.vde.com\AGB-Institut). Das Recht zur Benutzung erstreckt sich nur auf die bezeichnete Firma mit den genannten Fertigungsstätten und die oben aufgeführten Produkte mit den zugeordneten Bezeichnungen. Die Fertigungsstätte muss so eingerichtet sein, dass eine gleichmäßige Herstellung der geprüften und zertifizierten Ausführung gewährleistet ist.

Die Genehmigung ist so lange gültig wie die VDE-Bestimmungen gelten, die der Zertifizierung zugrunde gelegen haben, sofern sie nicht auf Grund anderer Bedingungen aus der VDE Prüf- und Zertifizierungsordnung (PM102) zurückgezogen werden muss.

Der Gültigkeitszeitraum einer VDE-GS-Zeichengenehmigung kann auf Antrag verlängert werden. Bei gesetzlichen und / oder normativen Änderungen kann die VDE-GS-Zeichengenehmigung ihre Gültigkeit zu einem früheren als dem angegebenen Datum verlieren.

Produkte, die das Biozid Dimethylfumarat (DMF) enthalten, dürfen gemäß der Kommissionsentscheidung 2009/251/EG nicht mehr in den Verkehr gebracht oder auf dem Markt bereitgestellt werden.

Der VDE-Zeichengenehmigungsausweis wird ausschließlich auf der ersten Seite unterzeichnet.

Approval to use the legally protected Mark of the VDE as shown on the first page:

Basis for the use are the general terms and conditions of the VDE Testing and Certification Institute (www.vde.com\terms-institute). The right to use the mark is granted only to the mentioned company with the named places of manufacture and the listed products with the related type references. The place of manufacture shall be equipped in a way that a constant manufacturing of the certified construction is assured.

The approval is valid as long as the VDE specifications are in force, on which the certification is based on, unless it is withdrawn according to the VDE Testing and Certification Procedure (PM102E).

The validity period of a VDE-GS-Mark Approval may be prolonged on request. In case of changes in legal and / or normative requirements, the validity period of a VDE-GS-Mark Approval may be shortened.

Products containing the biocide dimethylfumarate (DMF) may not be marketed or made available on the EC market according to the Commission Decision 2009/251/EC.

The approval is solely signed on the first page.

