

# 東莞永力電業有限公司

YUNG LI CO., LTD

Da Pu Industrial Zone, Gang Zi, Changping Town,  
Dong Guan City, Guangdong 523571 China.P.R.C

TEL:0769-83396797~8

FAX:0769-83396796

E-mail: sales@yung-li.com

Description: YP-EG/YC-12

Customer: \_SY

Parts No. : UT?`?Sge?E\_

Draw No. :

## REVISION RECORD

1		
2		
3		
4		
5		

YUNG LI	
CHECKED	PREPARED BY

CUSTOMER	APPROVED

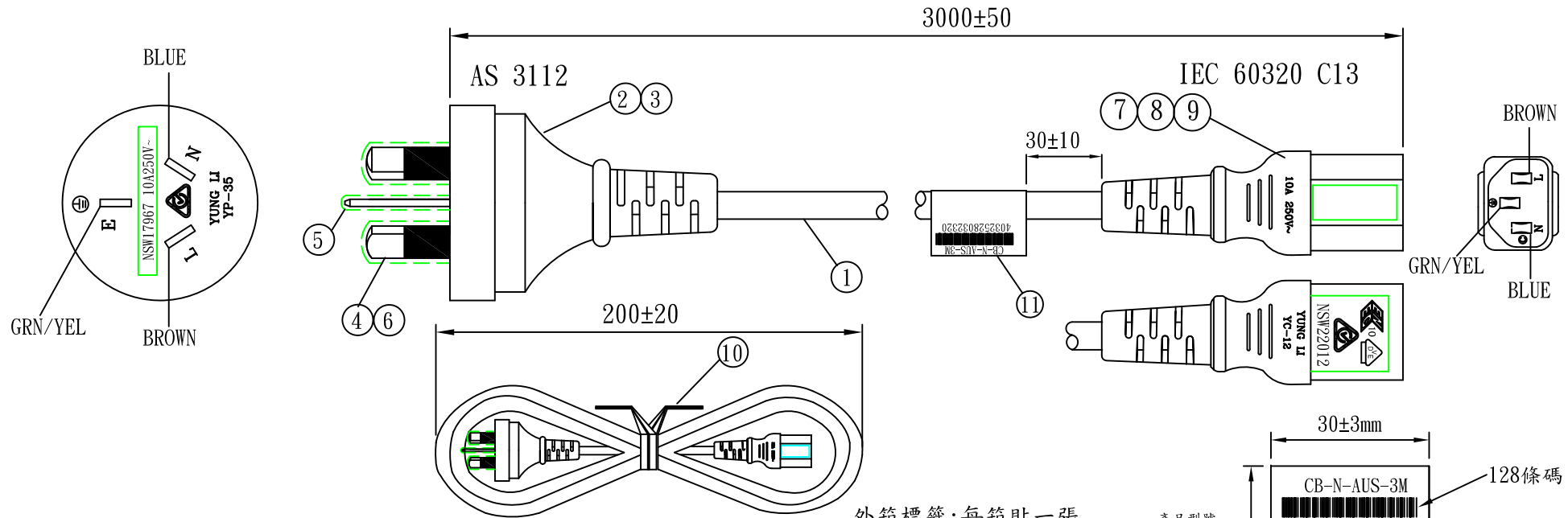

外箱標籤:每箱貼一張

產品型號: YP-35/YC-12  
 電流電壓: 250V~ 10A  
 License holder: Yung Li Co.,Ltd  
 Mark: YUNG LI  
 Manufacturer: Yung Li Co.,Ltd  
 Address: Da Pu Industrial Zone,  
 Gang Zi Chang Ping Town,  
 Dong Guan City, Guang Dong,  
 China 523571

128條碼: 4032528032320  
 掃描內容為: 4032528032320

Dimensions: 60mm x 60mm x 50mm±3

NO.	SPECIFICATION	QTY	REMARK
1	H05VV-F 1.0/3C BLACK	1PC	
2	YP-35 PVC PLASTIC:50P BLACK	32g/PC	
3	YP-35 INNER BODY WHITE	1PC	
4	SAA TER:P97658BS-1	2PCS	
5	SAA TER:98658BS-1	1PC	
6	SLEEVE:3PIN WHITE	1PC	
7	YC-12 PVC PLASTIC:50P BLACK	18g/PC	
8	"U" TER:97740BS-0	3PCS	
9	YC-12 INNER BODY	1PC	
10	MINI TIE:L=180mm BLACK	1PC	
11	LABEL:50X30mm 128Code	1PC	Label-7770
12	BOX LABEL:60X60mm	1PC	包裝打印

TOLERANCE	APPROVED	DATE	YUNG LI CO.,LTD			
	>0±0.30	CHECKED	DATE			
>1.0±0.50	DRAWN	SUKI	DATE	19.09.25	CUSTOMER	MAG
>10.0±1.0	TYPE	YP-35/YC-12		P/N	CB-N-AUS-3M	
>20.0±2.0	DRAWING NO.	CY-S0145-02	REV	B	MATERIAL	P. V. C
Angle: ±1°					HEFT(g)	UNIT
						mm

NSW17967

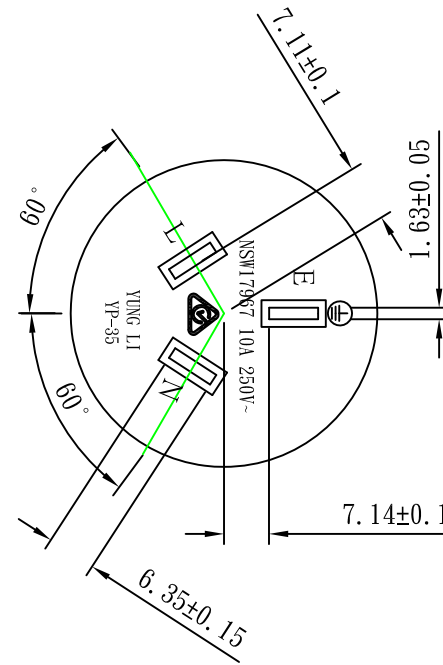
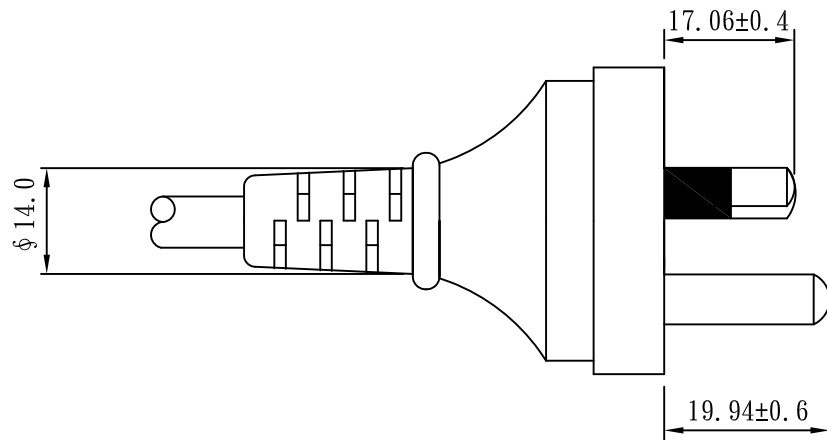
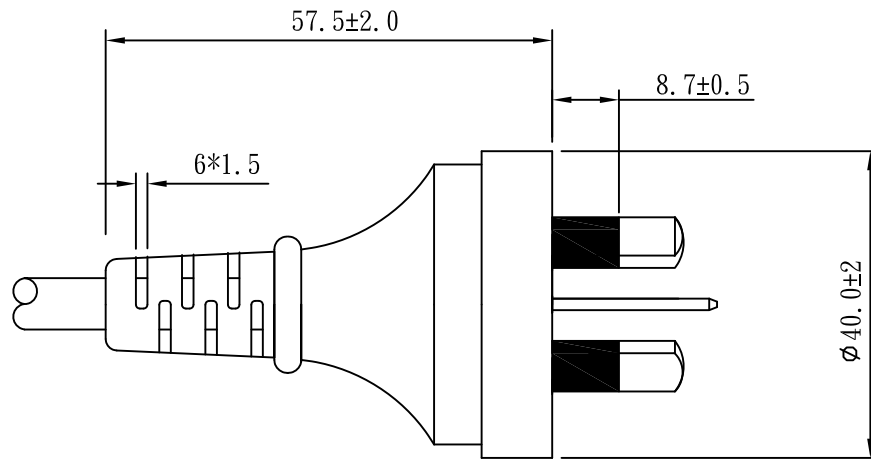

TOLERANCE >0±0.30 >1.0±0.50 >10.0±1.0 >20.0±2.0 Angle: ±1°	APPROVED		DATE		YUNG LI CO., LTD.			
	CHECKED		DATE					
	DRAWN	Melon	DATE	18.06.29				
	TYPE	YP-35			P/N			
DRAWING NO					MATERIAL	P.V.C	UNIT	mm
					SCALE	1:1		



NSW22012

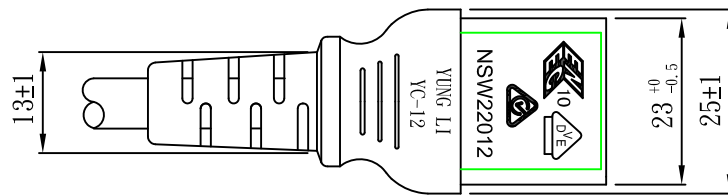
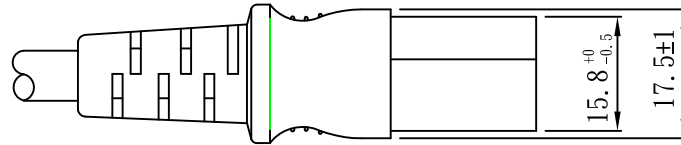
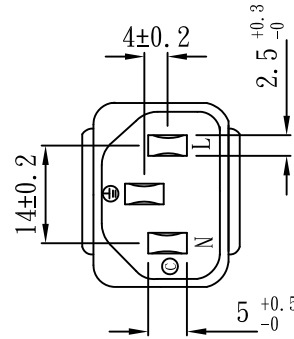
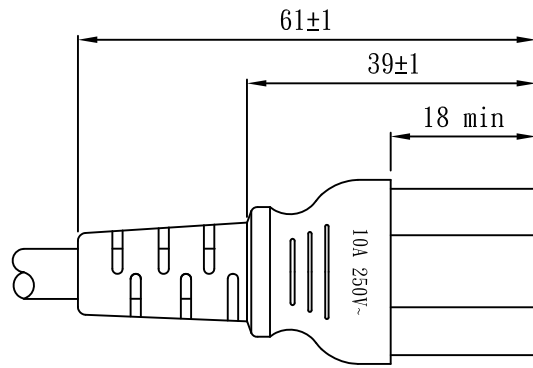

TOLERANCE >0±0.30 >1.0±0.50 >10.0±1.0 >20.0±2.0 Angle: ±1°	APPROVED		DATE	YUNG LI CO., LTD				
	CHECKED		DATE					
	DRAWN		DATE	CUSTOMER				
	TYPE	YC-12			P/N			
	DRAWING NO.		REV	B	MATERIAL	P. V. C	UNIT	mm
					SCALE	1:1		

# YUNG LI CO., LTD

## SPECIFICATION

Yung Li	Style	PVC FLEXIBLE CORDS	Document No
2019.04.16			
Edition	Size	<b>H05VV-F 3G 1.0mm<sup>2</sup></b>	Page
A			1/2

1. Standard: IEC 227 IEC228

2. Construction & Dimension

	Item	Specification
Conductor	Size	3G 1.0mm <sup>2</sup>
	Material	Annealed Bare Copper
	Construction	32/ $\phi$ 0.202±0.005
Insulation	Material	PVC
	Minimum Average Thickness	0.60mm
	Minimum Thickness at any point	0.48mm
	Diameter	2.50 ± 0.10
	Identification	Blue,Brown,Green/Yellow
Core Assembly	Core Twist	3-Core
	Filler	NA
	Assembly Pair	NA
Taping	Mylar Foil	NA
Shielded	A1-Mylar Foil	NA
Drain	Material	NA
	Construction	NA
Jacket	Material	NA
	Minimum Average Thickness	0.8mm
	Minimum Thickness at any point	0.58mm
	Overall Diameter(Approx)	7.0± 0.15
	Color	BLACK

### Marking:

Yung Li Co., Ltd. H05VV-F 3G 1.0mm<sup>2</sup> <VDE> NF-USE 1347  KEMA-KEUR  CEBC <OVE>

IEMMEQU SAA-190646-EA  A004049 60227 IEC 53(RVV) 300/500V  SU01027-4002

# YUNG LI CO., LTD

## SPECIFICATION

Yung Li	Style	PVC FLEXIBLE CORDS	Document No
2019.04.16			
Edition	Size	<b>H05VV-F 3G 1.0mm<sup>2</sup></b>	Page
A			2/2

### 4. Electrical & Physical Properties

Item	Specification		
Rating Voltage	70°C 300/500V		
Conductor resistance(AT 20°C)	19.5 Ω/Km MAX		
Insulation Resistance(AT 70°C)	0.010MΩ/Km Min		
Dielectric Strength	AC 2.0 KV / 15 min No Break		
Spark Test	5.0KV		
Insulation	Unaged	Tensile Strength	1.02 kgf/mm <sup>2</sup> min
		Elongation	150% Min
	Aged	Tensile Strength	80~120% (80°C x168hrs)
		Elongation	80~120% (80°C x168hrs)
	Loss of mass Test		2.0mg/cm <sup>2</sup> (max)
Jacket	Unaged	Tensile Strength	1.02 kgf/mm <sup>2</sup> min
		Elongation	150% Min
	Aged	Tensile Strength	80~120% (80°C x168hrs)
		Elongation	80~120% (80°C x168hrs)
	Loss of mass Test		2.0mg/cm <sup>2</sup> (max)
Deformation Test		70±4°C X 1hr ≤ 50%	
Cold Bend Test		-15°C x 4hr No Crack	
Heat Shock Test		150±2°C x 1hr No Crack	

### Graph:

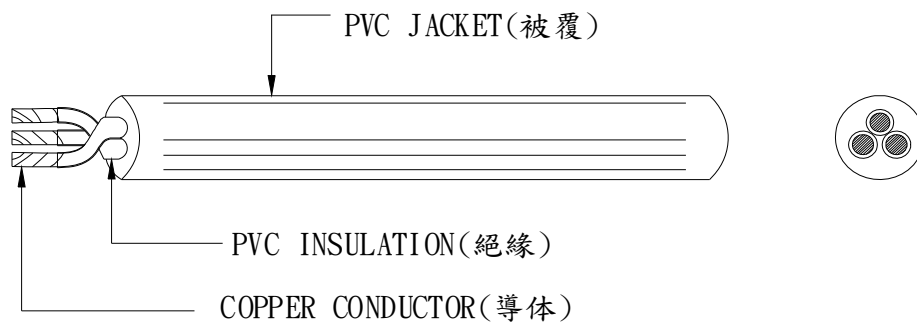



# CERTIFICATE OF APPROVAL

ISSUED PURSUANT TO SECTION 21C OF THE ELECTRICITY SAFETY ACT 1945

**ISSUED TO:**

Yung Li Co Ltd

**CLASS OF ARTICLE:**

Plug

**DESCRIPTION OF ARTICLE:**

**Plug (Insulated Pin)**

[Non-rewirable, three-pin, flat-pin (two-insulated live pins), black thermoplastic moulded plug with a white thermoplastic insert, integrally moulded to any <HAR> certified H05VV-F 3G0.75mm<sup>2</sup>, or Australian approved three-core, 0.75mm<sup>2</sup>, PVC insulated and sheathed, ordinary duty circular flexible cord] 250V, 10A

**EXAMINED FOR COMPLIANCE WITH:** AS/NZS 3112 : 2000

**TYPE REFERENCE CODE:** Type No. YP-35

**APPROVAL MARK:**

Each electrical article of the abovementioned type shall be marked with Approval Number N17967 or N14876

**DATE OF APPROVAL:** 25 September 2001

This approval expires 25 September 2006 unless suspended, cancelled, renewed or extended.

  
for **DIRECTOR-GENERAL**



DEPARTMENT OF **FAIR TRADING**

NSW Consumer Protection Agency

**ADDENDUM TO CERTIFICATE OF APPROVAL No 17967**

**Particulars of Modification(s)**

1. Original Type No. YP-35 alternatively moulded to any of the following <HAR> certified or equivalent Australian approved flexible cords:-
  - (a) H05VV-F 3G1.00mm<sup>2</sup>.
  - (b) H05VV-F 2X0.75mm<sup>2</sup>.
  - (c) H05VV-F 2X1.00mm<sup>2</sup>.
  - (d) H03VV-F 3G0.75mm<sup>2</sup>.
  - (e) H03VV-F 2X0.75mm<sup>2</sup>.
  - (f) H05VVH2-F 2X1.00mm<sup>2</sup>
  - (g) H05VVH2-F 2X0.75mm<sup>2</sup>
  
2. Type YP-36 being similar to original Type No. YP-35 except two-pin in lieu of three-pin, and alternatively moulded to any of the following <HAR> certified or Australian approved flexible cords:-
  - (a) H03VVH2-F 2X0.75mm<sup>2</sup>.
  - (b) H05VVH2-F 2X0.75mm<sup>2</sup>.
  - (c) H05VVH2-F 2X1.00mm<sup>2</sup>.
  - (d) H03VV-F 2X0.75mm<sup>2</sup>.
  - (e) H05VV-F 2X0.75mm<sup>2</sup>.
  - (f) H05VV-F 2X1.00mm<sup>2</sup>.

Approved: 25 September 2001

for DIRECTOR-GENERAL





**OFFICE OF FAIR TRADING**

*NSW Consumer Protection Agency*  
Department of Commerce

**ADDENDUM TO CERTIFICATE OF APPROVAL No 17967**

**Particulars of Modification(s)**

Model No. YP-36 to use the alternative approval mark N15572.

Approved: 03 March 2005

A handwritten signature in black ink, appearing to be 'R. K.', is written over the text 'Approved: 03 March 2005'.

for Commissioner

Ref: 17967/3

**ADDENDUM TO CERTIFICATE OF APPROVAL 17967**

**Particulars of Modification(s)**

- (a) **Original Type No. YP-35 alternatively moulded to a 'Yung Li' Type H05VV-F 3G1.5mm<sup>2</sup> flexible cord (Q04083).**
- (b) **General Modification:  
Plugs now comply with AS/NZS3112 : 2004.**

Approved: 01 May 2006



for Commissioner for Fair Trading

Ref: 17967/4

**RENEWAL OF CERTIFICATE OF APPROVAL 17967**

**PARTICULARS OF RENEWAL**

The approval of Plug Type No. YP-35 and all approved modifications has been renewed for a period of FIVE years.

**Date of Renewal: 05 September 2006**

**The Approval expires on 25 September 2011 unless it is renewed, extended, suspended or cancelled.**



**for Commissioner for Fair Trading**

**ADDENDUM TO CERTIFICATE OF APPROVAL 17967**

**Particulars of Modification(s)**

1. Type YP-35 alternatively moulded to any <HAR> certified H05RR-F 3G1.00mm<sup>2</sup> or equivalent Australian approved flexible cord.
2. Type YP-39 being similar to Type YP-35 except :-
  - (a) Having 15A in lieu of 10A construction.
  - (b) Marked 15A in lieu of 10A.
  - (c) Alternatively moulded to any <HAR> certified H05VV-F 3G1.5mm<sup>2</sup> or H05RR-F 3G1.5mm<sup>2</sup> or equivalent Australian approved flexible cords.
3. General Modification.  
Plugs now comply with AS/NZS3112:2001 A1

Approved: 10 May 2007



for Commissioner for Fair Trading



Fair  
Trading

Ref: NSW17967/7

RENEWAL OF CERTIFICATE OF APPROVAL NSW17967

PARTICULARS OF RENEWAL

The approval of Plug Type No. YP-35 and all approved modifications has been renewed for a period of FIVE years.

The Approval expires on 25/09/2016 unless it is renewed, extended, suspended or cancelled.

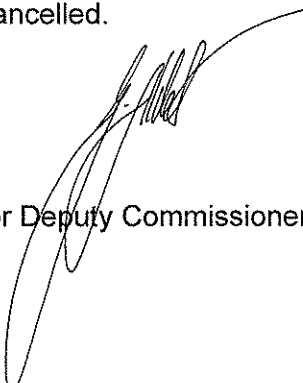

for Deputy Commissioner, Fair Trading Operations



Fair  
Trading

Ref: NSW17967/8

FILE COPY

## ADDENDUM TO CERTIFICATE OF APPROVAL: NSW17967 Particulars of Modification(s)

Model No. YP-35 is alternatively moulded to any <HAR> certified H05RN-F 3G0.75/1.0mm<sup>2</sup> or equivalent Australian approved flexible cord. Plug enclosure and pin supporter can be of any colour;

Model No. YP-35L is identical to YP-35 except for cord connection of side-entry type in lieu of straight-entry. It can be moulded to any <HAR> certified H05RN-F 3G0.75/1.0mm<sup>2</sup>, or H05RR-F 3G0.75/1.0/1.5mm<sup>2</sup>, or H05VV-F 3G0.75/1.0/1.5mm<sup>2</sup>, or equivalent Australian approved flexible cord. Plug enclosure and pin supporter can be of any colour;

Model No. YP-36 is alternatively moulded to any <HAR> certified H05RN-F 2x0.75/1.0mm<sup>2</sup> or equivalent Australian approved flexible cord. Plug enclosure and pin supporter can be of any colour;

Model No. YP-39 is alternatively moulded to any <HAR> certified H05RN-F 3G0.75/1.0mm<sup>2</sup>, or H05VV-F 3G2.5mm<sup>2</sup>, or equivalent Australian approved flexible cord. Plug enclosure and pin supporter can be of any colour.

This certificate will expire on 25/09/2016

Approved: 17 July 2013

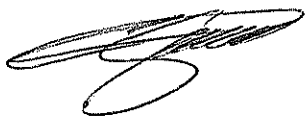

18/7/2013

For Commissioner for Fair Trading



Fair  
Trading

Ref: NSW17967/9

## RENEWAL OF CERTIFICATE OF APPROVAL: NSW17967

### Particulars of Renewal

The approval of Plug Type No. YP-35 and all approved modifications has been renewed for a period of FIVE years.

The Approval expires on 14/04/2021 unless it is renewed, extended, suspended or cancelled.



For Commissioner for Fair Trading

## ZEICHENGENEHMIGUNG MARKS APPROVAL

Yung-Li Co. Ltd.  
Da Pu Industrial Zone, Cang Zi  
Chang Ping Town  
523571 DONG GUAN CITY  
Guangdong  
CHINA

ist berechtigt, für ihr Produkt /  
*is authorized to use for their product*

**Gerätesteckdose, nicht-wiederanschließbar**  
**Connector, non-rewirable**

die hier abgebildeten markenrechtlich geschützten Zeichen  
für die ab Blatt 2 aufgeführten Typen zu benutzen /  
*the legally protected Marks as shown below for the types referred to on page 2 ff.*

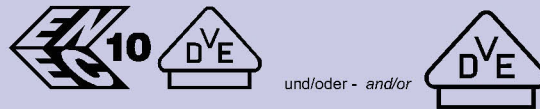

Geprüft und zertifiziert nach /  
*Tested and certified according to*

DIN EN 60320-1 (VDE 0625-1):2016-04; EN 60320-1:2015+AC:2016  
DIN EN 60320-3 (VDE 0625-3):2015-11; EN 60320-3:2014  
IEC 60320-1:2015  
IEC 60320-3:2014

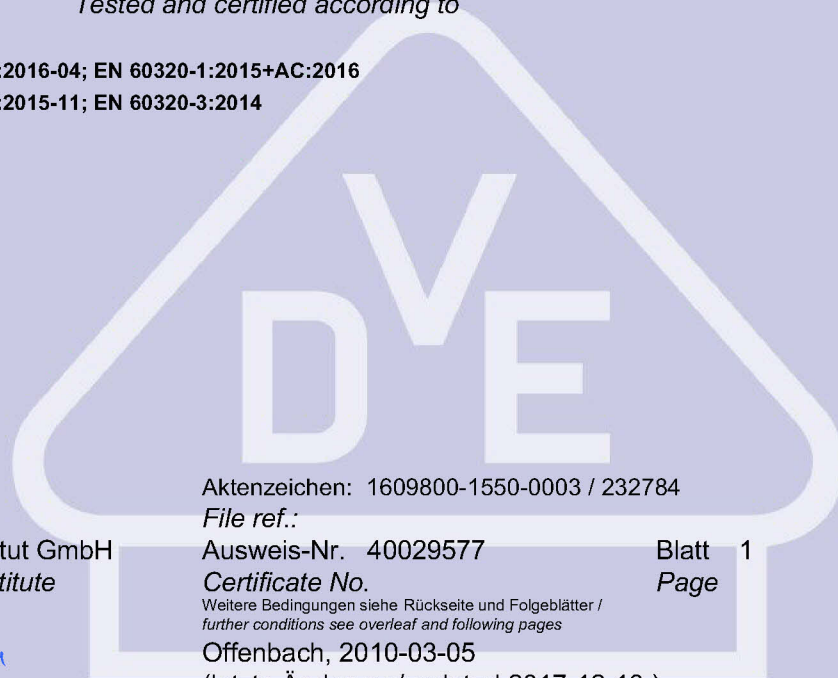

Aktenzeichen: 1609800-1550-0003 / 232784

File ref.:

Ausweis-Nr. 40029577

Blatt 1

Certificate No.

Page

Weitere Bedingungen siehe Rückseite und Folgeblätter /  
*further conditions see overleaf and following pages*

Offenbach, 2010-03-05

(letzte Änderung/updated 2017-12-13 )

VDE Prüf- und Zertifizierungsinstitut GmbH  
VDE Testing and Certification Institute  
Zertifizierungsstelle / Certification

G. Heine

VDE Zertifikate sind nur gültig bei Veröffentlichung unter:  
VDE certificates are valid only when published on:

<http://www.vde.com/zertifikat>  
<http://www.vde.com/certificate>



Name und Sitz des Genehmigungs-Inhabers / *Name and registered seat of the Certificate holder*

Yung-Li Co. Ltd., Da Pu Industrial Zone, Cang Zi, Chang Ping Town, 523571 DONG GUAN CITY, Guangdong, CHINA

Aktenzeichen / *File ref.*

1609800-1550-0003 / 232784 / TL3 / E

letzte Änderung / *updated*

2017-12-13

Datum / *Date*

2010-03-05

Dieses Blatt gilt nur in Verbindung mit Blatt 1 des Zeichengenehmigungsausweises Nr. 40029577.

*This supplement is only valid in conjunction with page 1 of the Certificate No. 40029577.*

## Gerätesteckdose, nicht-wiederanschließbar *Connector, non-rewirable*

Typ(en) / *Type(s)*

- 1) YC-12
- 2) YC-12L

Bemessungsspannung  
*Rated voltage*

AC 250 V

Bemessungsstrom  
*Rated current*

10 A

Polzahl  
*Number of poles*

2-polig mit Schutzkontakt  
*2-pole with earthing contact*

Bauart  
*Kind of construction*

Normblatt C13  
*standard sheet C13*

Ausführung(en)  
*Construction(s)*

zentrale Leitungseinführung  
*straight cable entry*  
Für / *for* 1)

abgewinkelte Leitungseinführung  
*angled cable entry*  
Für / *for* 2)

Warenzeicheninhaber  
*Trademark holder*

Yung Li Co. Ltd.

Produktinformation

siehe Anlage Nr. 300 + 700 + 702 + 703 + 900 vom 2017-11-02  
und  
Anlage Nr. 701 vom 2017-12-13

*Product information*

*see Appendix No. 300 + 700 + 702 + 703 + 900 dated  
2017-11-02  
and  
Appendix No. 701 dated 2017-12-13*

Fortsetzung siehe Blatt 3 /  
*continued on page 3*

# VDE Prüf- und Zertifizierungsinstitut Zeichengenehmigung

Ausweis-Nr. / Blatt /  
Certificate No. / Page  
40029577 3

Name und Sitz des Genehmigungs-Inhabers / *Name and registered seat of the Certificate holder*

Yung-Li Co. Ltd., Da Pu Industrial Zone, Cang Zi, Chang Ping Town, 523571 DONG GUAN CITY, Guangdong, CHINA

Aktenzeichen / *File ref.*

1609800-1550-0003 / 232784 / TL3 / E

letzte Änderung / *updated*

2017-12-13

Datum / *Date*

2010-03-05

Dieses Blatt gilt nur in Verbindung mit Blatt 1 des Zeichengenehmigungsausweises Nr. 40029577.

*This supplement is only valid in conjunction with page 1 of the Certificate No. 40029577.*

Dieser Zeichengenehmigungs-Ausweis bildet eine Grundlage für die EG-Konformitätserklärung und CE-Kennzeichnung durch den Hersteller oder dessen Bevollmächtigten und bescheinigt die Konformität mit den grundlegenden Schutzanforderungen der **EG-Niederspannungsrichtlinie 2014/35/EU**.

*This Marks Approval is a basis for the EC Declaration of Conformity and the CE Marking by the manufacturer or his agent and proves the conformity with the essential safety requirements of the **EC Low-Voltage Directive 2014/35/EU**.*

VDE Prüf- und Zertifizierungsinstitut GmbH

*VDE Testing and Certification Institute*

Fachgebiet TL3

*Section TL3*

# VDE Prüf- und Zertifizierungsinstitut Zeichengenehmigung

Ausweis-Nr. / Beiblatt /  
Certificate No. Supplement  
40029577

Name und Sitz des Genehmigungs-Inhabers / *Name and registered seat of the Certificate holder*

Yung-Li Co. Ltd., Da Pu Industrial Zone, Cang Zi, Chang Ping Town, 523571 DONG GUAN CITY, Guangdong, CHINA

Aktenzeichen / *File ref.*

1609800-1550-0003 / 232784 / TL3 / E

letzte Änderung / *updated*

2017-12-13

Datum / *Date*

2010-03-05

Dieses Beiblatt ist Bestandteil des Zeichengenehmigungsausweises Nr. 40029577.

*This supplement is part of the Certificate No. 40029577.*

## Gerätesteckdose, nicht-wiederanschließbar *Connector, non-rewirable*

### Fertigungsstätte(n)

*Place(s) of manufacture*

Referenz/*Reference*

**30008928**

Yung-Li Co. Ltd.

Da Pu Industrial Zone, Cang Zi

Chang Ping Town

523571 DONG GUAN CITY

Guangdong

CHINA

VDE Prüf- und Zertifizierungsinstitut GmbH

*VDE Testing and Certification Institute*

Fachgebiet TL3

*Section TL3*



Name und Sitz des Genehmigungs-Inhabers / *Name and registered seat of the Certificate holder*

Yung-Li Co. Ltd., Da Pu Industrial Zone, Cang Zi, Chang Ping Town, 523571 DONG GUAN CITY, Guangdong, CHINA

Aktenzeichen / *File ref.*

1609800-1550-0003 / 232784 / TL3 / E

letzte Änderung / *updated*

2017-12-13

Datum / *Date*

2010-03-05

Dieses Blatt gilt nur in Verbindung mit Blatt 1 des Zeichengenehmigungsausweises Nr. 40029577.

*This supplement is only valid in conjunction with page 1 of the Certificate No. 40029577.*

## **Genehmigung zum Benutzen des auf Seite 1 abgebildeten markenrechtlich geschützten Zeichens des VDE:**

Grundlage für die Benutzung sind die Allgemeinen Geschäftsbedingungen (AGB) der VDE Prüf- und Zertifizierungsinstitut GmbH ([www.vde.com\AGB-Institut](http://www.vde.com\AGB-Institut)). Das Recht zur Benutzung erstreckt sich nur auf die bezeichnete Firma mit den genannten Fertigungsstätten und die oben aufgeführten Produkte mit den zugeordneten Bezeichnungen. Die Fertigungsstätte muss so eingerichtet sein, dass eine gleichmäßige Herstellung der geprüften und zertifizierten Ausführung gewährleistet ist.

Die Genehmigung ist so lange gültig wie die VDE-Bestimmungen gelten, die der Zertifizierung zugrunde gelegen haben, sofern sie nicht auf Grund anderer Bedingungen aus der VDE Prüf- und Zertifizierungsordnung (PM102) zurückgezogen werden muss.

Der Gültigkeitszeitraum einer VDE-GS-Zeichengenehmigung kann auf Antrag verlängert werden. Bei gesetzlichen und / oder normativen Änderungen kann die VDE-GS-Zeichengenehmigung ihre Gültigkeit zu einem früheren als dem angegebenen Datum verlieren.

Produkte, die das Biozid Dimethylfumarat (DMF) enthalten, dürfen gemäß der Kommissionsentscheidung 2009/251/EG nicht mehr in den Verkehr gebracht oder auf dem Markt bereitgestellt werden.

Der VDE-Zeichengenehmigungsausweis wird ausschließlich auf der ersten Seite unterzeichnet.

### **Approval to use the legally protected Mark of the VDE as shown on the first page:**

*Basis for the use are the general terms and conditions of the VDE Testing and Certification Institute ([www.vde.com\terms-institute](http://www.vde.com\terms-institute)). The right to use the mark is granted only to the mentioned company with the named places of manufacture and the listed products with the related type references. The place of manufacture shall be equipped in a way that a constant manufacturing of the certified construction is assured.*

*The approval is valid as long as the VDE specifications are in force, on which the certification is based on, unless it is withdrawn according to the VDE Testing and Certification Procedure (PM102E).*

*The validity period of a VDE-GS-Mark Approval may be prolonged on request. In case of changes in legal and / or normative requirements, the validity period of a VDE-GS-Mark Approval may be shortened.*

*Products containing the biocide dimethylfumarate (DMF) may not be marketed or made available on the EC market according to the Commission Decision 2009/251/EC.*

*The approval is solely signed on the first page.*

Certificate Number: 22012

# CERTIFICATE OF APPROVAL

ISSUED PURSUANT TO THE ELECTRICITY (CONSUMER SAFETY) ACT 2004

**ISSUED TO:**

Yung Li Co Ltd

**CLASS OF ARTICLE:**

Appliance Connector

**DESCRIPTION OF ARTICLE:**

Appliance Connector  
(Non-rewirable, straight entry, Group 1, C13 appliance connector for cold conditions for Class I equipment integrally moulded to any <HAR> certified H05VV-F 3G1.00mm<sup>2</sup> or Australian approved three-core, 1.00mm<sup>2</sup>, PVC insulated and sheathed ordinary duty circular flexible cord)  
250V, ac, 10A

**EXAMINED FOR COMPLIANCE WITH:** AS/NZS 60320.1 : 2004

**TYPE REFERENCE CODE:** Type No. YC-12

**APPROVAL MARK:**

Each electrical article of the abovementioned type shall be marked with Approval Number NSW22012 or N14877 ;or  
the Regulatory Compliance Mark (RCM) provided that the requirements of all relevant parts of AS/NZS 4417 applicable to the article are fulfilled.

**DATE OF APPROVAL:** 31 October 2006

This approval expires 31 October 2011 unless suspended, cancelled, renewed or extended.



for Commissioner for Fair Trading

Ref: 22012/1

**ADDENDUM TO CERTIFICATE OF APPROVAL 22012****Particulars of Modification(s)**

1. Type No. YC-12 alternatively moulded to any <HAR> certified H05VV-F 3G0.75mm<sup>2</sup> or Australian approved, three-core, 0.75mm<sup>2</sup>, PVC insulated and sheathed ordinary duty circular flexible cord not exceeding two metres in length.
  
2. Type No. YP-32 being similar to original Type No. YC-12 except a Standard Sheet 'E' Interconnection Plug Connector (AS/NZS 60320.2.2) alternatively moulded to either:-
  - (a) Any <HAR> certified H05VV-F 3G1.00mm<sup>2</sup> or equivalent Australian approved flexible cord; or
  - (b) Any <HAR> certified H05VV-F 3G0.75mm<sup>2</sup> or equivalent Australian approved flexible cord not exceeding two metres in length.
  
3. Type No. YC-12 alternatively moulded to any <HAR> certified H05VV-F 3G1.5mm<sup>2</sup> or Australian approved three-core, 1.5mm<sup>2</sup>, PVC insulated and sheathed ordinary duty circular flexible cord.

Approved: 31 October 2006



for Commissioner for Fair Trading



Fair  
Trading

Ref: NSW22012/2

RENEWAL OF CERTIFICATE OF APPROVAL NSW22012

PARTICULARS OF RENEWAL

The approval of the original appliance connector Model YC-12 and approved modifications has been renewed.

The Approval expires on 31/10/2016 unless it is renewed, extended, suspended or cancelled.

A handwritten signature in black ink, appearing to be "D. J. ...".

For Commissioner for Fair Trading



Fair  
Trading

Ref: NSW22012/3

## RENEWAL OF CERTIFICATE OF APPROVAL: NSW22012

### Particulars of Renewal

The approval of the original appliance connector Model YC-12 and approved modifications has been renewed for FIVE years.

The Approval expires on 31/10/2021 unless it is renewed, extended, suspended or cancelled.

For Commissioner for Fair Trading



## ZEICHENGENEHMIGUNG MARKS APPROVAL

Yung-Li Co. Ltd.  
Da Pu Industrial Zone, Cang Zi  
Chang Ping Town  
523571 DONG GUAN CITY  
Guangdong  
CHINA

ist berechtigt, für ihr Produkt /  
*is authorized to use for their product*

**Starkstromleitungen für allgemeine Anwendungen**  
**- Flexible Leitungen**  
**mit thermoplastischer PVC-Isolierung**  
***Cables for general applications***  
**- *Flexible cables with***  
***thermoplastic PVC insulation***

die hier abgebildeten markenrechtlich geschützten Zeichen  
für die ab Blatt 2 aufgeführten Typen zu benutzen /  
*the legally protected Marks as shown below for the types referred to on page 2 ff.*



oder/or



oder/or



schwarz  
black

rot  
red

Geprüft und zertifiziert nach /  
*Tested and certified according to*

DIN EN 50525-2-11 (VDE 0285-525-2-11):2012-01; EN 50525-2-11:2011

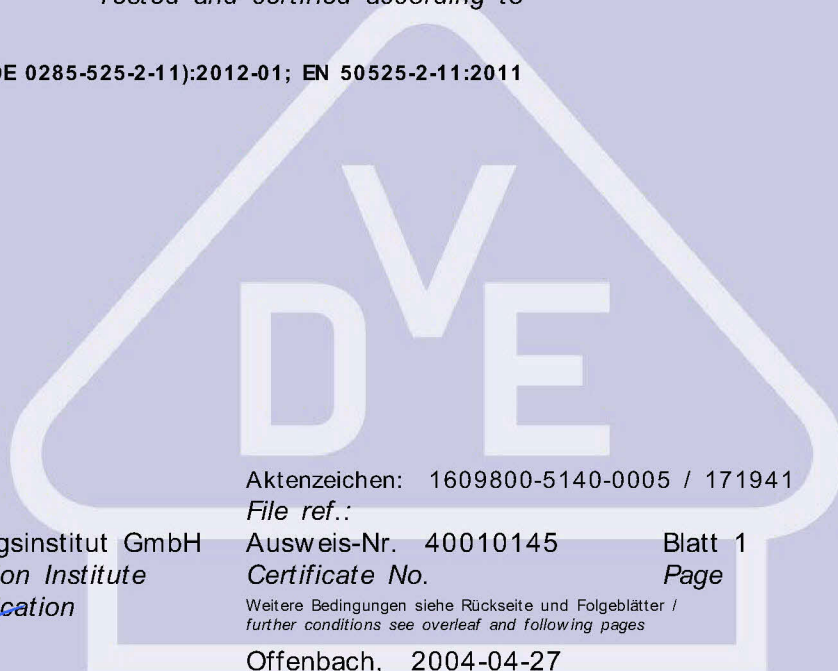

VDE Prüf- und Zertifizierungsinstitut GmbH  
*VDE Testing and Certification Institute*  
Zertifizierungsstelle / *Certification*

K. Prohaska

VDE Zertifikate sind nur gültig bei Veröffentlichung unter:  
*VDE certificates are valid only when published on:*

Aktenzeichen: 1609800-5140-0005 / 171941  
*File ref.:*

Ausweis-Nr. 40010145 Blatt 1  
*Certificate No. Page*

Weitere Bedingungen siehe Rückseite und Folgeblätter /  
*further conditions see overleaf and following pages*

Offenbach, 2004-04-27  
(letzte Änderung/updated 2012-09-25 )

<http://www.vde.com/zertifikat>  
<http://www.vde.com/certificate>

Name und Sitz des Genehmigungs-Inhabers / *Name and registered seat of the Certificate holder*  
Yung-Li Co. Ltd., Da Pu Industrial Zone, Cang Zi, Chang Ping Town, 523571 DONG GUAN CITY,  
Guangdong, CHINA

Aktenzeichen / *File ref.*  
1609800-5140-0005 / 171941 / FG42 / HEG

letzte Änderung / *updated* Datum / *Date*  
2012-09-25 2004-04-27

Dieses Blatt gilt nur in Verbindung mit Blatt 1 des Zeichengenehmigungsausweises Nr. 40010145  
*This supplement is only valid in conjunction with page 1 of the Certificate No. 40010145.*

**Starkstromleitungen für allgemeine Anwendungen**  
**- Flexible Leitungen**  
**mit thermoplastischer PVC-Isolierung**  
***Cables for general applications***  
**- Flexible cables with**  
***thermoplastic PVC insulation***

Typ(en) / *Type(s)*:

H03VV-F 2...4 x 0,5...0,75 mm <sup>2</sup>	+
H03VVH2-F 2 x 0,5...0,75 mm <sup>2</sup>	+
H05VV-F 2...5 x 0,75...4 mm <sup>2</sup>	+
H05VVH2-F 2 x 0,75...1,0 mm <sup>2</sup>	+

Leitungsbauart <i>Type of cable</i>	Standardleitungen <i>General purpose cables</i>
--	--

Firmenzeichen <i>Trademark</i>	YUNG LI
-----------------------------------	---------

Dieser Zeichengenehmigungs-Ausweis bildet eine Grundlage für die EG-Konformitätserklärung und CE-Kennzeichnung durch den Hersteller oder dessen Bevollmächtigten und bescheinigt die Konformität mit den grundlegenden Schutzanforderungen der **EG-Niederspannungsrichtlinie 2006/95/EG** mit ihren Änderungen.

*This Marks Approval is a basis for the EC Declaration of Conformity and the CE Marking by the manufacturer or his agent and proves the conformity with the essential safety requirements of the EC Low-Voltage Directive 2006/95/EC including amendments.*

VDE Prüf- und Zertifizierungsinstitut GmbH  
*VDE Testing and Certification Institute*  
Fachgebiet FG42  
*Section FG42*

Name und Sitz des Genehmigungs-Inhabers / *Name and registered seat of the Certificate holder*  
Yung-Li Co. Ltd., Da Pu Industrial Zone, Cang Zi, Chang Ping Town, 523571 DONG GUAN CITY,  
Guangdong, CHINA

Aktenzeichen / *File ref.*  
1609800-5140-0005 / 171941 / FG42 / HEG

letzte Änderung / *updated* Datum / *Date*  
2012-09-25 2004-04-27

Dieses Beiblatt ist Bestandteil des Zeichengenehmigungsausweises Nr. 40010145.  
*This supplement is part of the Certificate No. 40010145.*

**Starkstromleitungen für allgemeine Anwendungen**  
**- Flexible Leitungen**  
**mit thermoplastischer PVC-Isolierung**  
***Cables for general applications***  
**- Flexible cables with**  
***thermoplastic PVC insulation***

**Fertigungsstätte(n)**  
***Place(s) of manufacture***

Referenz/*Reference*      Yung-Li Co. Ltd.  
**30008928**                Da Pu Industrial Zone, Cang Zi  
                                 Chang Ping Town  
                                 523571 DONG GUAN CITY  
                                 Guangdong  
                                 CHINA

VDE Prüf- und Zertifizierungsinstitut GmbH  
*VDE Testing and Certification Institute*  
Fachgebiet FG42  
*Section FG42*

Name und Sitz des Genehmigungs-Inhabers / *Name and registered seat of the Certificate holder*

Yung-Li Co. Ltd., Da Pu Industrial Zone, Cang Zi, Chang Ping Town, 523571 DONG GUAN CITY,  
Guangdong, CHINA

Aktenzeichen / *File ref.*

1609800-5140-0005 / 171941 / FG42 / HEG

letzte Änderung / *updated* Datum / *Date*

2012-09-25

2004-04-27

Dieses Blatt gilt nur in Verbindung mit Blatt 1 des Zeichengenehmigungsausweises Nr. 40010145

*This supplement is only valid in conjunction with page 1 of the Certificate No. 40010145.*

**Genehmigung zum Benutzen des auf Seite 1 abgebildeten markenrechtlich geschützten Zeichens des VDE:**

Grundlage für die Benutzung sind die Allgemeinen Geschäftsbedingungen (AGB) der VDE Prüf- und Zertifizierungsinstitut GmbH ([www.vde.com](http://www.vde.com)\AGB-Institut). Das Recht zur Benutzung erstreckt sich nur auf die bezeichnete Firma mit den genannten Fertigungsstätten und die oben aufgeführten Produkte mit den zugeordneten Bezeichnungen. Die Fertigungsstätte muss so eingerichtet sein, dass eine gleichmäßige Herstellung der geprüften und zertifizierten Ausführung gewährleistet ist.

Die Genehmigung ist so lange gültig wie die VDE-Bestimmungen gelten, die der Zertifizierung zugrunde gelegen haben, sofern sie nicht auf Grund anderer Bedingungen aus der VDE Prüf- und Zertifizierungsordnung (PM102) zurückgezogen werden muss.

Der Gültigkeitszeitraum einer VDE-GS-Zeichengenehmigung kann auf Antrag verlängert werden. Bei gesetzlichen und / oder normativen Änderungen kann die VDE-GS-Zeichengenehmigung ihre Gültigkeit zu einem früheren als dem angegebenen Datum verlieren.

Produkte, die das Biozid Dimethylfumarat (DMF) enthalten, dürfen gemäß der Kommissionsentscheidung 2009/251/EG nicht mehr in den Verkehr gebracht oder auf dem Markt bereitgestellt werden.

Der VDE-Zeichengenehmigungsausweis wird ausschließlich auf der ersten Seite unterzeichnet.

***Approval to use the legally protected Mark of the VDE as shown on the first page:***

*Basis for the use are the general terms and conditions of the VDE Testing and Certification Institute ([www.vde.com](http://www.vde.com)\terms-institute). The right to use the mark is granted only to the mentioned company with the named places of manufacture and the listed products with the related type references. The place of manufacture shall be equipped in a way that a constant manufacturing of the certified construction is assured.*

*The approval is valid as long as the VDE specifications are in force, on which the certification is based on, unless it is withdrawn according to the VDE Testing and Certification Procedure (PM102E).*

*The validity period of a VDE-GS-Mark Approval may be prolonged on request. In case of changes in legal and / or normative requirements, the validity period of a VDE-GS-Mark Approval may be shortened.*

*Products containing the biocide dimethylfumarate (DMF) may not be marketed or made available on the EC market according to the Commission Decision 2009/251/EC.*

*The approval is solely signed on the first page.*