

# 東莞永力電業有限公司

YUNG LI CO., LTD

Da Pu Industrial Zone, Gang Zi, Changping Town,  
Dong Guan City, Guangdong 523571 China.P.R.C

TEL:0769-83396797~8

FAX:0769-83396796

E-mail: sales@yung-li.com

Description: YP-26/YC-14

Customer: MAG

Parts No. : CB-3-DK

Draw No. :

## *REVISION RECORD*

1		
2		
3		
4		
5		

YUNG LI	
CHECKED	PREPARED BY

CUSTOMER	APPROVED

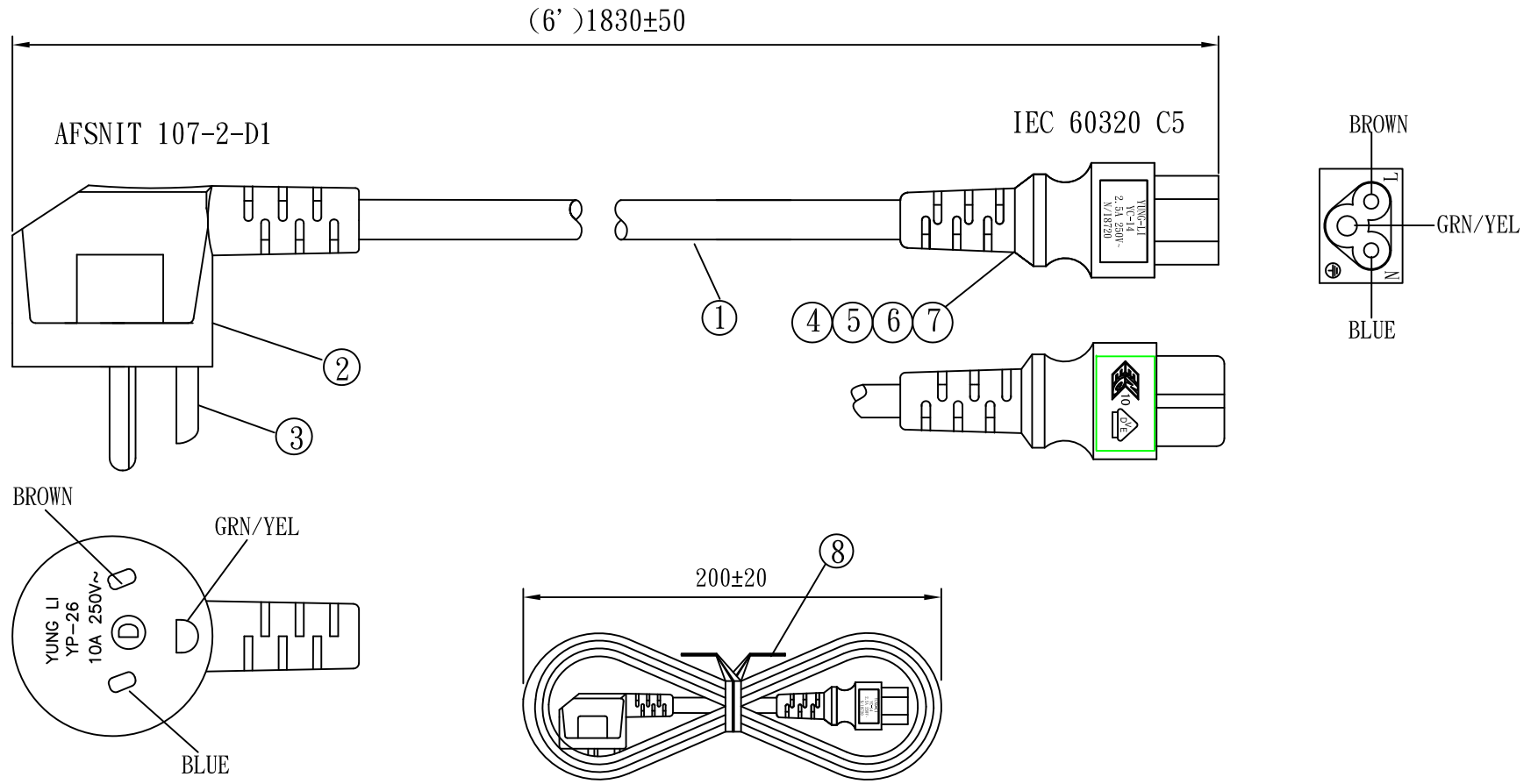

Ⓓ

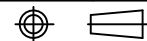
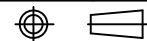

NO.	SPECIFICATION	Q' TY	REMARK
1	H05VV-F 0.75/3G BLACK	1PC	1810±20(YL)
2	YP-26 PVC PLASTIC:50P BLACK	27g/PC	
3	FRAME WHITE:P98073D-1W	1PC	
4	YC-14 PVC PLASTIC:50P BLACK	18g/PC	
5	YC-14 TER:98714PS-0	2PCS	
6	YC-14 TER:98732PS-0	1PC	
7	YC-14 INNER BODY BLACK	1PC	
8	MINI TIE:L=130mm BLACK	1PC	

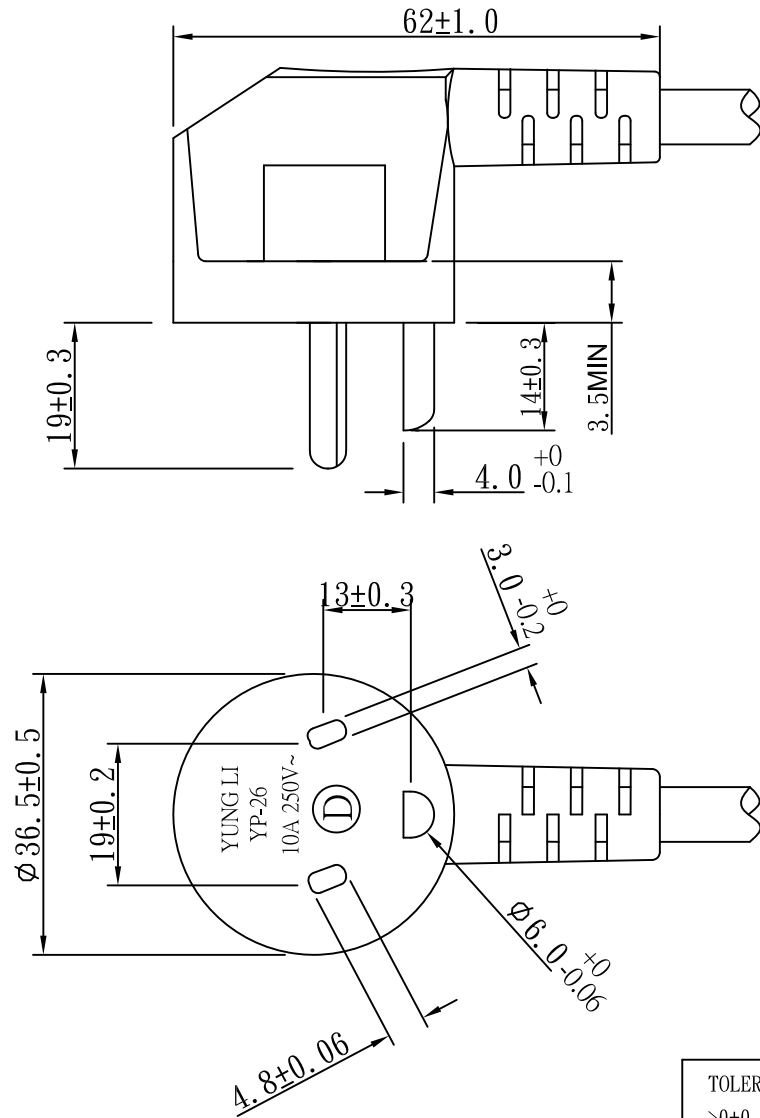
Tolerance >0±0.30 >1.0±0.50 >10.0±1.0 >20.0±2.0 Angle: ±1°	Approved		Date		YUNG LI CO., LTD.			
	Checked		Date					
	Drawn	SUKI	Date	12.11.16	Customer	MAG		
	Cat. No.	YP-26/YC-14			P/N.	CB-3-DK		
	Drawing No.	CY-V0283		Rev.	B	Material	P. V. C	Unit
					Scale			



TOLERANCE >0±0.30 >1.0±0.50 >10.0±1.0 >20.0±2.0 Angle: ±1°	APPROVED		DATE		YUNG LI CO., LTD.			
	CHECKED		DATE					
	DRAWN		DATE					
	TYPE	YP-26		P/N				
	DRAWING NO			MATERIAL	P.V.C	UNIT	mm	
				SCALE	1:1	 		



N18720

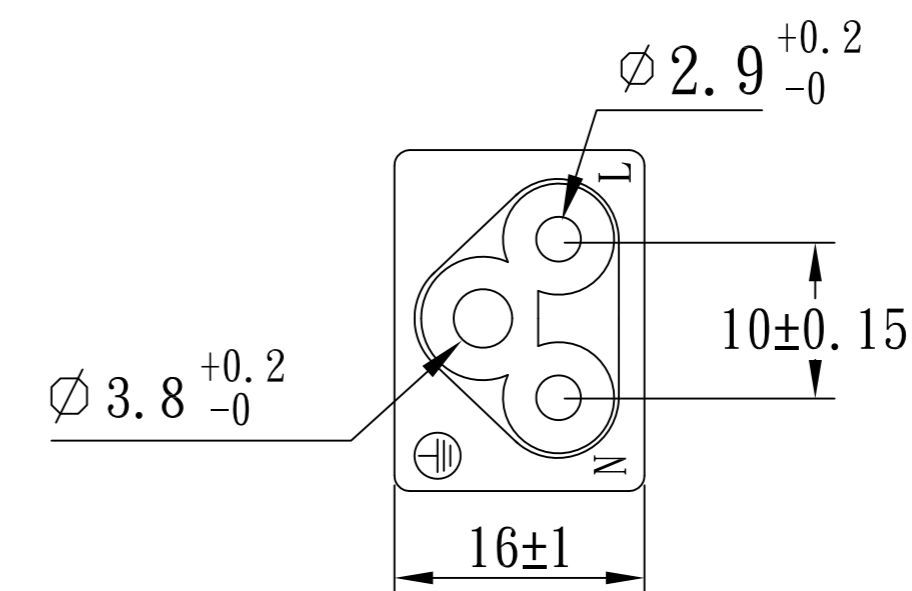
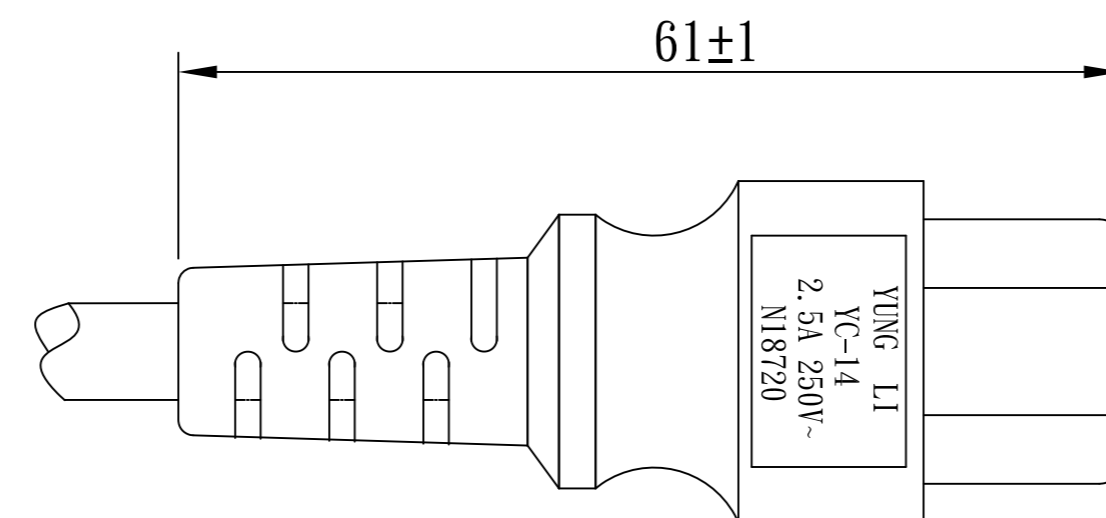
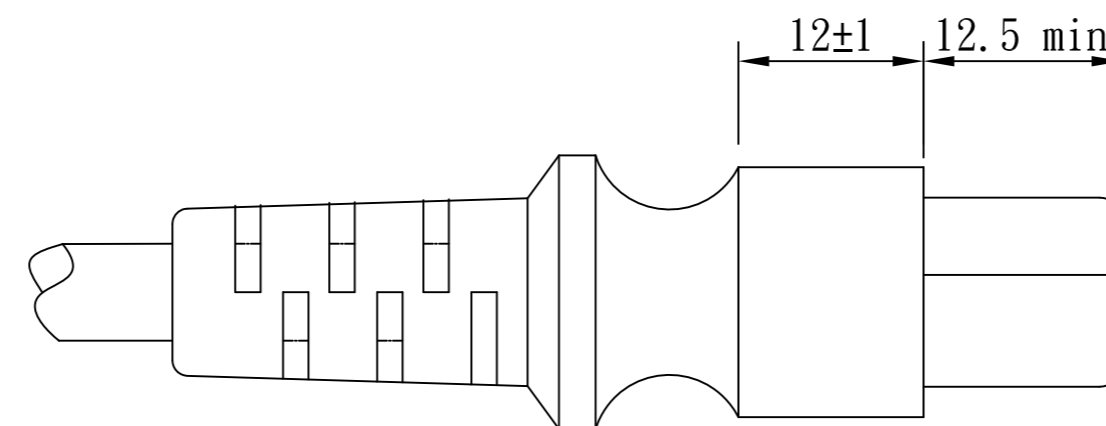
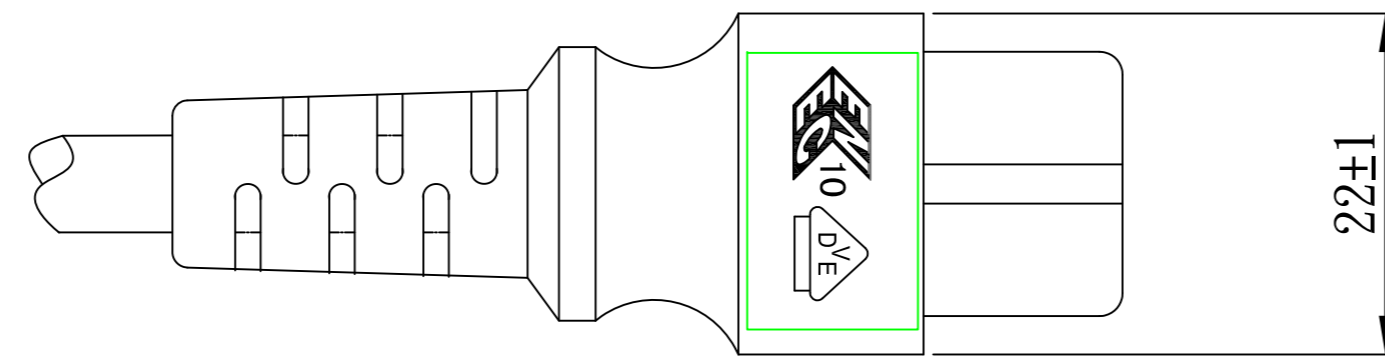

TOLERANCE >0±0.30 >1.0±0.50 >10.0±1.0 >20.0±2.0 Angle: ±1°	APPROVED		DATE		YUNG LI CO., LTD.			
	CHECKED		DATE					
	DRAWN		DATE					
	TYPE	YC-14 (ENEC)		P/N				
	DRAWING NO			MATERIAL	P.V.C	UNIT	mm	
				SCALE	1:1			

# YUNG LI CO., LTD











## SPECIFICATION

Yung Li	Style	PVC FLEXIBLE CORDS	Document No
2012.7.18			YL-V01001
Edition	Size	<b>H05VV-F 3G 0.75mm<sup>2</sup></b>	Page
A			1/2

1. Standard: IEC 227 IEC228  
 2. Construction & Dimension

	Item	Specification
Conductor	Size	3G 0.75mm <sup>2</sup>
	Material	Annealed Bare Copper
	Construction	24/ § 0.2±0.01
Insulation	Material	PVC
	Minimum Average Thickness	0.60mm
	Minimum Thickness at any point	0.44mm
	Diameter	2.35 ± 0.10
	Identification	Blue,Brown, Yellow/Green
Core Assembly	Core Twist	3-Core
	Filler	NA
	Assembly Pair	NA
Taping	Mylar Foil	NA
Shielded	A1-Mylar Foil	NA
Drain	Material	NA
	Construction	NA
Jacket	Material	PVC
	Minimum Average Thickness	0.8mm
	Minimum Thickness at any point	0.58mm
	Overall Diameter(Approx)	6.7 ± 0.15
	Color	Any Color

### Marking:

Yung Li Co., Ltd. H05VV-F 3G 0.75mm<sup>2</sup> <VDE> NF-USE 1347  KEMA-KEUR   <OVE>  
     IEMMEQU Q04083  A004049 60227 IEC 53(RVV) 300/500V  SU01027-4002

# YUNG LI CO., LTD

## SPECIFICATION

Yung Li	Style	PVC FLEXIBLE CORDS	Document No
2012.7.18			YL-V01001
Edition	Size	<b>H05VV-F 3G 0.75mm<sup>2</sup></b>	Page
A			2/2

### 4. Electrical & Physical Properties

Item	Specification		
Rating Voltage	70°C 300/500V		
Conductor resistance(AT 20°C)	26.0Ω/Km MAX		
Insulation Resistance(AT 70°C)	0.011MΩ/Km Min		
Dielectric Strength	AC 2.0 KV / 15 min No Break		
Spark Test	6.0KV		
Insulation	Unaged	Tensile Strength	1.02 kgf/mm <sup>2</sup> min
		Elongation	150% Min
	Aged	Tensile Strength	80~120% (80°C x168hrs)
		Elongation	80~120% (80°C x168hrs)
	Loss of mass Test		2.0mg/cm <sup>2</sup> (max)
Jacket	Unaged	Tensile Strength	1.02 kgf/mm <sup>2</sup> min
		Elongation	150% Min
	Aged	Tensile Strength	80~120% (80°C x168hrs)
		Elongation	80~120% (80°C x168hrs)
	Loss of mass Test		2.0mg/cm <sup>2</sup> (max)
Deformation Test		70±2°C X 4hr ≤ 50%	
Cold Bend Test		-15°C x 1hr No Crack	
Heat Shock Test		150±2°C x 1hr No Crack	

### Graph:

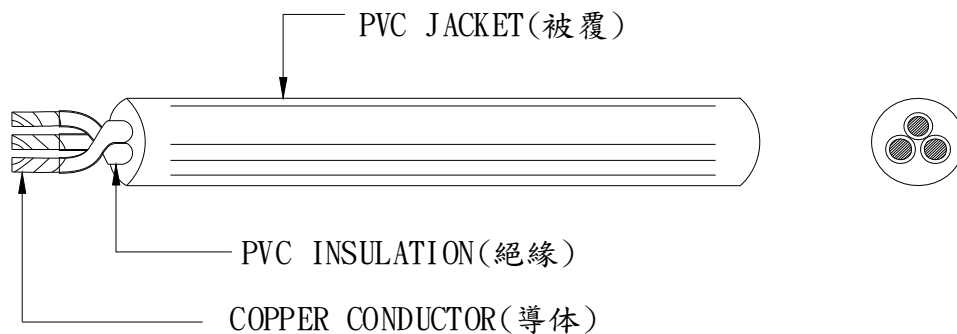

# DEMKO CERTIFICATE

**Certificate No.** D-01373  
**Page** 1/3  
**Date of Issue** 2012-06-19

**Certificate Holder** YUNG LI CO LTD  
DA PU INDUSTRIAL ZONE  
CHANG PING TOWN  
DONGGUAN, 523571 GUANGDONG China

**Manufacturer** YUNG LI CO LTD  
DA PU INDUSTRIAL ZONE  
CHANG PING TOWN  
DONGGUAN, 523571 GUANGDONG China

**Production site** YUNG LI CO LTD  
DA PU INDUSTRIAL ZONE  
CHANG PING TOWN  
DONGGUAN, 523571 GUANGDONG China

**Certified Product Model** Non-rewirable two-pole IT plug with earthing pin  
YP-26

**Trademark**

**YUNG LI**

**Rated Voltage / Frequency** 250V ac  
**Rated Current / Power** 10A  
**Insulation Class** -  
**Degree of protection (IP)** 20  
**Tested acc. to** DS 60884-2-D1:2011  
**Test Report No.** 12DF6216 issued on 2012-06-13  
**Additional**  
**Expire date** 2022-06-19

**Certification Manager**  
Jan-Erik Storgaard

**Certification Body**

The product and production sites listed on the certificate comply with the D-mark requirements and the UL Global Service Agreement, with reference to Terms and Conditions for the D mark. The Owner of the certificate is entitled to use the d or for cables <DEMKO>, for the products listed on the certificate and manufactured at the production sites listed. UL has to be informed in writing about any changes to the product or production site in accordance with the Term and Conditions of the D mark. The validity of the certificate is shortened if the EU legislation require re-testing and re-certification due to new standards or amendments coming into force before the expiry date.

**UL International Demko A/S, Borupvang 5A, DK-2750  
Ballerup, Denmark, Tel. +45 44 85 65 65,  
info.dk@ul.com  
www.ul-europe.com**



# Appendix DEMKO CERTIFICATE

**Certificate No.** D-01373  
**Page** 2/3  
**Date of Issue** 2012-06-19

**Additional Information:**

For class I equipment.

YP-26 with cord H05VV-F 3G 0.75, 1.0, 1.5 mm<sup>2</sup>,

Standard Sheet: DK 2-5a (SB 107-2-D1)

---

**Certification Body**

**UL International Demko A/S, Borupvang 5A, DK-2750  
Ballerup, Denmark, Tel. +45 44 85 65 65,  
info.dk@ul.com  
www.ul-europe.com**





# Appendix DEMKO CERTIFICATE

Certificate No. D-01373  
Page 3/3  
Date of Issue 2012-06-19

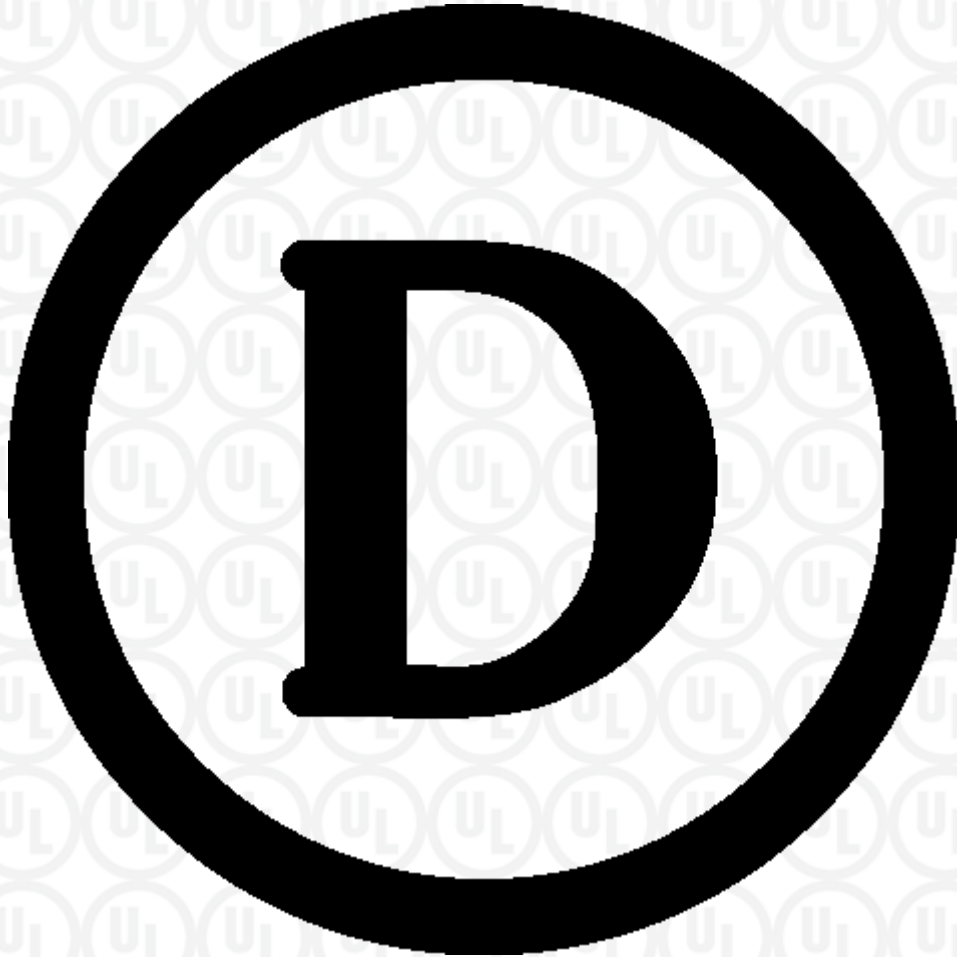

---

Certification Body

UL International Demko A/S, Borupvang 5A, DK-2750  
Ballerup, Denmark, Tel. +45 44 85 65 65,  
info.dk@ul.com  
www.ul-europe.com



# VDE Prüf- und Zertifizierungsinstitut

## ZEICHENGENEHMIGUNG MARKS APPROVAL

Yung-Li Co. Ltd.  
Da Pu Industrial Zone  
Chang Ping Town  
523571 DONG GUAN CITY  
Guangdong  
CHINA

ist berechtigt, für ihr Produkt /  
is authorized to use for their product

Gerätesteckdose, nicht-wiederanschließbar  
Connector, non-rewirable

die hier abgebildeten markenrechtlich geschützten Zeichen  
für die ab Blatt 2 aufgeführten Typen zu benutzen /  
the legally protected Marks as shown below for the types referred to on page 2 ff.



Geprüft und zertifiziert nach /  
Tested and certified according to

DIN EN 60320-1 (VDE 0625-1):2008-05; EN 60320-1:2001 + A1:2007



VDE Prüf- und Zertifizierungsinstitut GmbH  
VDE Testing and Certification Institute  
Zertifizierungsstelle / Certification

Aktenzeichen: 1609800-1550-0006 / 126561  
File ref.:

Ausweis-Nr. 40029893      Blatt 1  
Certificate No.                      Page

Weitere Bedingungen siehe Rückseite und Folgebblätter /  
further conditions see overleaf and following pages

Offenbach, 2010-04-21

VDE Zertifikate sind nur gültig bei Veröffentlichung unter:  
VDE certificates are valid only when published on:

<http://www.vde.com/zertifikat>  
<http://www.vde.com/certificate>

# VDE



# VDE Prüf- und Zertifizierungsinstitut

## Zeichengenehmigung

Ausweis-Nr. / Blatt /  
Certificate No. page  
40029893 2

Name und Sitz des Genehmigungs-Inhabers / *Name and registered seat of the Certificate holder*  
Yung-Li Co. Ltd., Da Pu Industrial Zone, Chang Ping Town, 523571 DONG GUAN CITY, Guangdong,  
CHINA

Aktenzeichen / *File ref.*  
1609800-1550-0006 / 126561 / FG31 / E

Datum / *Date*  
2010-04-21

Dieses Blatt gilt nur in Verbindung mit Blatt 1 des Zeichengenehmigungsausweises Nr. 40029893.  
*This supplement is only valid in conjunction with page 1 of the Certificate No. 40029893.*

### Gerätesteckdose, nicht-wiederanschließbar *Connector, non-rewirable*

Typ(en) / *Type(s)*:

YC-14  
YC-14L

Bemessungsspannung <i>Rated voltage</i>	AC 250 V
Bemessungsstrom <i>Rated current</i>	2,5 A
Polzahl <i>Number of poles</i>	2-polig mit Schutzkontakt <i>2-pole with earthing contact</i>
Bauart <i>Kind of construction</i>	Normblatt C5 <i>standard sheet C5</i>
Anmerkung(en) <i>Remark(s)</i>	Gerätesteckdosen 2,5 A mit Schutzkontakt müssen Teil einer Geräteanschlußleitung oder einer Weiterverbindungs-Geräteanschlußleitung sein. <i>Connectors 2,5 A with earthing contact shall be part of a cord set or interconnection cord set</i>
PAK	Das Produkt entspricht den Anforderungen gemäß PAK-Dokument ZEK 01.2-08.
PAH	<i>The product is in accordance with the requirements of PAH-document ZEK 01.2-08.</i>
Warenzeicheninhaber <i>Trademark holder</i>	Yung-Li Co. Ltd.
Produktinformation <i>Product information</i>	siehe Anlage Nr. 300 + 400 + 900 <i>see Appendix No. 300 + 400 + 900</i>

Fortsetzung siehe Blatt 3 /  
*continued on page 3*

VDE Prüf- und Zertifizierungsinstitut GmbH \* Testing and Certification Institute

Merianstrasse 28, D-63069 Offenbach

Phone + 49 (0) 69 83 06-0  
Telefax + 49 (0) 69 83 06-555



# CERTIFICATE OF APPROVAL

ISSUED PURSUANT TO SECTION 21C OF THE ELECTRICITY SAFETY ACT 1945

ISSUED TO:

Yung Li Co Ltd

CLASS OF ARTICLE:

Appliance Connector

DESCRIPTION OF ARTICLE:

Appliance Connector  
(Non-rewirable, thermoplastic moulded, straight-entry, C5 appliance connector for cold conditions, for class I equipment, integrally moulded to any <HAR> certified H05VV-F 3G0.75-1mm<sup>2</sup>, or Australian approved three-core 0.75mm<sup>2</sup> or 1.00mm<sup>2</sup>, PVC insulated and sheathed ordinary duty circular flexible cord) 250V, ac, 2.5A

EXAMINED FOR COMPLIANCE WITH: AS/NZS 3109 : 1996 A1

TYPE REFERENCE CODE: Type No. YC-14

APPROVAL MARK:

Each electrical article of the abovementioned type shall be marked with Approval Number N18720

DATE OF APPROVAL: 23 August 2002

This approval expires 23 August 2007 unless suspended, cancelled, renewed or extended.

for DIRECTOR-GENERAL

澳洲



Ref: 18720/1

**RENEWAL OF CERTIFICATE OF APPROVAL 18720**

**PARTICULARS OF RENEWAL**

The approval of the original model no. YC-14 has been renewed for a period of FIVE (5) years.

Date of Renewal: 23 August 2007

The Approval expires on 23 August 2012 unless it is renewed, extended, suspended or cancelled.

A handwritten signature in black ink, appearing to read "M. Hawks".

for Commissioner for Fair Trading

Ref: NSW18720/2

RENEWAL OF CERTIFICATE OF APPROVAL NSW18720

PARTICULARS OF RENEWAL

The approval of the original appliance connector model no. YC-14 has been renewed.

The Approval expires on 23/08/2017 unless it is renewed, extended, suspended or cancelled.



23.8.2012

For Commissioner for Fair Trading

# VDE Prüf- und Zertifizierungsinstitut

## ZEICHENGENEHMIGUNG MARKS APPROVAL

Yung-Li Co. Ltd.  
Da Pu Industrial Zone, Cang Zi  
Chang Ping Town  
523571 DONG GUAN CITY  
Guangdong  
CHINA

ist berechtigt, für ihr Produkt /  
is authorized to use for their product

Flexible Leitung  
Flexible cable (cord)

die hier abgebildeten markenrechtlich geschützten Zeichen  
für die ab Blatt 2 aufgeführten Typen zu benutzen /  
the legally protected Marks as shown below for the types referred to on page 2 ff.



oder/or



oder/or



Gepprüft und zertifiziert nach /  
Tested and certified according to

DIN VDE 0281-5 (VDE 0281 Teil 5):2002-09; HD 21.5 S3:1994 + A1:1999 + A2:2001

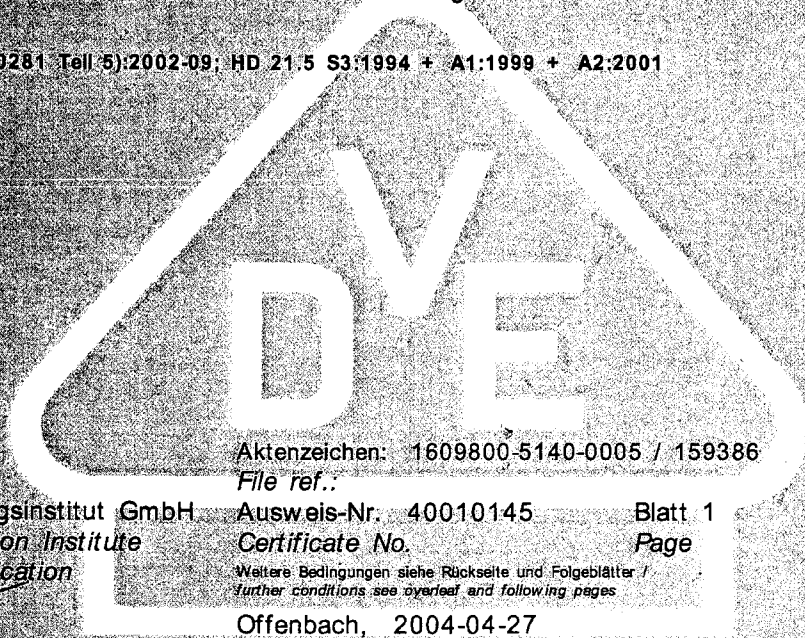

Aktenzeichen: 1609800-5140-0005 / 159386

File ref..

VDE Prüf- und Zertifizierungsinstitut GmbH  
VDE Testing and Certification Institute  
Zertifizierungsstelle / Certification

Ausweis-Nr. 40010145

Blatt 1

Certificate No.

Page

Weitere Bedingungen siehe Rückseite und Folgeblätter /  
further conditions see overleaf and following pages

Offenbach, 2004-04-27

(letzte Änderung/updated 2012-03-27 )

K. Prohaska

VDE Zertifikate sind nur gültig bei Veröffentlichung unter:  
VDE certificates are valid only when published on:

<http://www.vde.com/zertifikat>

<http://www.vde.com/certificate>

# VDE



# VDE Prüf- und Zertifizierungsinstitut Zeichengenehmigung

Ausweis-Nr. / Blatt /  
Certificate No. page  
40010145 2

Name und Sitz des Genehmigungs-Inhabers / *Name and registered seat of the Certificate holder*  
Yung-Li Co. Ltd., Da Pu Industrial Zone, Cang Zi, Chang Ping Town, 523571 DONG GUAN CITY,  
Guangdong, CHINA

Aktenzeichen / *File ref.*  
1609800-5140-0005 / 159386 / FG42 / STR

letzte Änderung / *updated* Datum / *Date*  
2012-03-27 2004-04-27

Dieses Blatt gilt nur in Verbindung mit Blatt 1 des Zeichengenehmigungsausweises Nr. 40010145  
*This supplement is only valid in conjunction with page 1 of the Certificate No. 40010145.*

## Flexible Leitung *Flexible cable (cord)*

Typ(en) / *Type(s)*:

H03VV-F 2...4 x 0,5...0,75 mm <sup>2</sup>	+
H03VVH2-F 2 x 0,5...0,75 mm <sup>2</sup>	+
H05VV-F 2...5 x 0,75...4 mm <sup>2</sup>	+
H05VVH2-F 2 x 0,75...1,0 mm <sup>2</sup>	+

Firmenzeichen YUNG LI  
*Trademark*

Dieser Zeichengenehmigungs-Ausweis bildet eine Grundlage für die EG-Konformitätserklärung und CE-Kennzeichnung durch den Hersteller oder dessen Bevollmächtigten und bescheinigt die Konformität mit den grundlegenden Schutzanforderungen der **EG-Niederspannungsrichtlinie 2006/95/EG** mit ihren Änderungen.

*This Marks Approval is a basis for the EC Declaration of Conformity and the CE Marking by the manufacturer or his agent and proves the conformity with the essential safety requirements of the EC Low-Voltage Directive 2006/95/EC including amendments.*

VDE Prüf- und Zertifizierungsinstitut GmbH  
*VDE Testing and Certification Institute*  
Fachgebiet FG42  
*Section FG42*