

東莞永力電業有限公司

YUNG LI CO., LTD

Da Pu Industrial Zone, Gang Zi, Changping Town,
Dong Guan City, Guangdong 523571 China.P.R.C

TEL:0769-83396797~8

FAX:0769-83396796

E-mail: sales@yung-li.com

Description: YP-61/YC-13D

Customer: MAG

Parts No. :

Draw No. :

REVISION RECORD

1		
2		
3		
4		
5		

YUNG LI		
CHECKED	PREPARED	BY

CUSTOMER	APPROVED

MARKING: YP-61 YUNG-LI $\frac{3}{250}$ BS1363/A 2011 APPR. BY ASTA LIC 839 L00244A SASO R304886
MADE IN CHINA

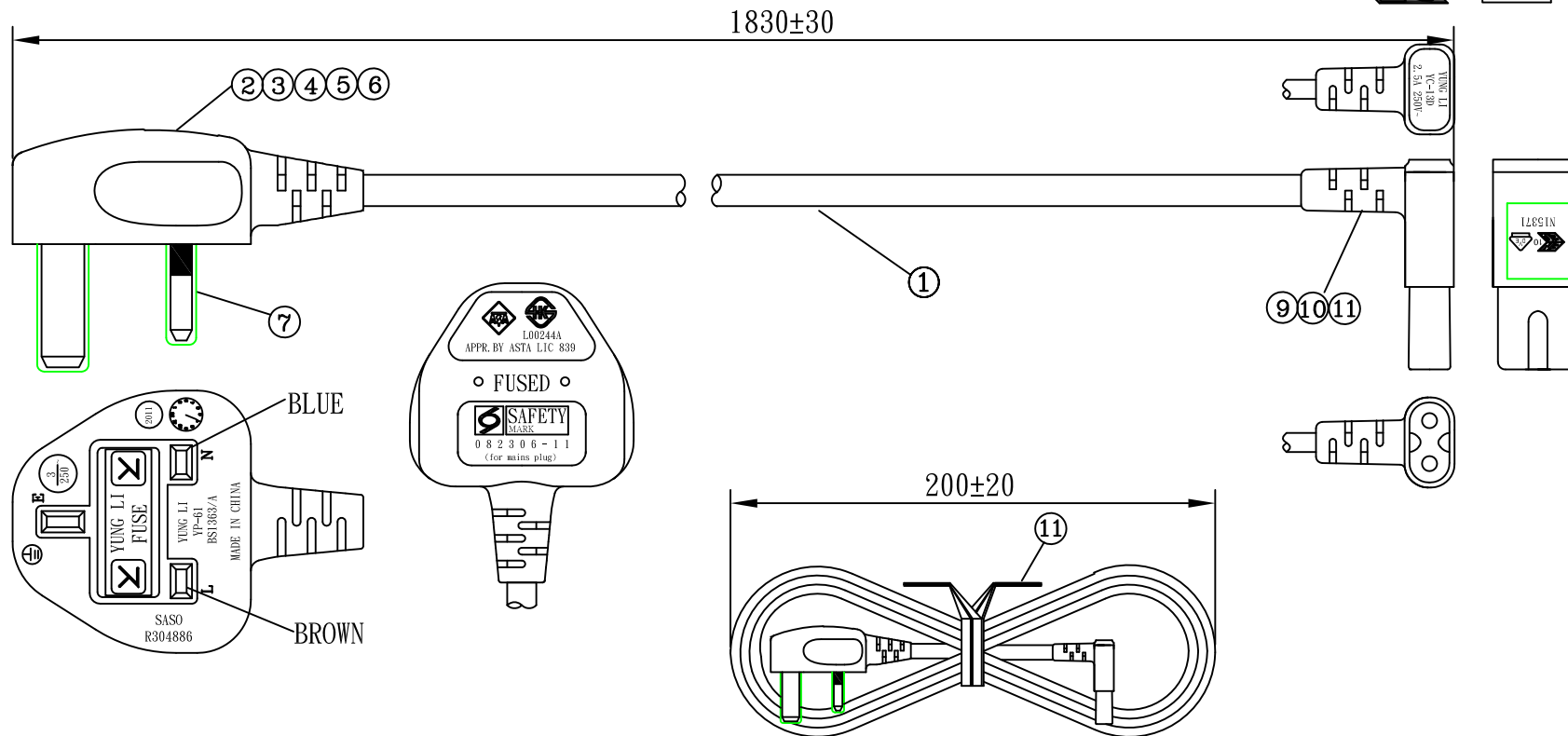

10 N/15371



NO.	SPECIFICATION	Q' TY	REMARK
1	H03VVH2-F 0.75/2C BLACK	1PC	
2	YP-61 PVC PLASTIC:60P BLACK	54g/PC	
3	FRAME:BLACK	1PC	
4	FUSE LID:BLACK	1PC	
5	FRAME LID	1PC	
6	FUSE:3A	1PC	
7	SLEEVE WHITE	1PC	
8	YC-13D H. S. G	1PC	
9	YC-13D TER	2PCS	
10	YC-13D PVC PLASTIC:50P BLACK	9g/PC	
11	MINI TIE:L=130mm BLACK	1PC	

Sample Drawing NO.:
SP110719-03

Tolerance >0±0.30 >1.0±0.50 >10.0±1.0 >20.0±2.0 Angle: ±1°	Approved		Date		YUNG LI CO., LTD.			
	Checked		Date					
	Drawn	SUKI	Date	11.07.19	Customer	MAG		
	Cat. No.	YP-61/YC-13D			P/N.	P-ZIP-06B-UK		
	Drawing No.		Rev.	B	Material	P. V. C	Unit	mm
				Scale				

MARKING: YP-61 YUNG-LI $\frac{3}{250}$ ~ BS1363/A   APPR. BY ASTA LIC 839

MADE IN CHINA



L00244A



0 8 2 3 0 6 - 1 1
(for mains plug)

SASO
R304886

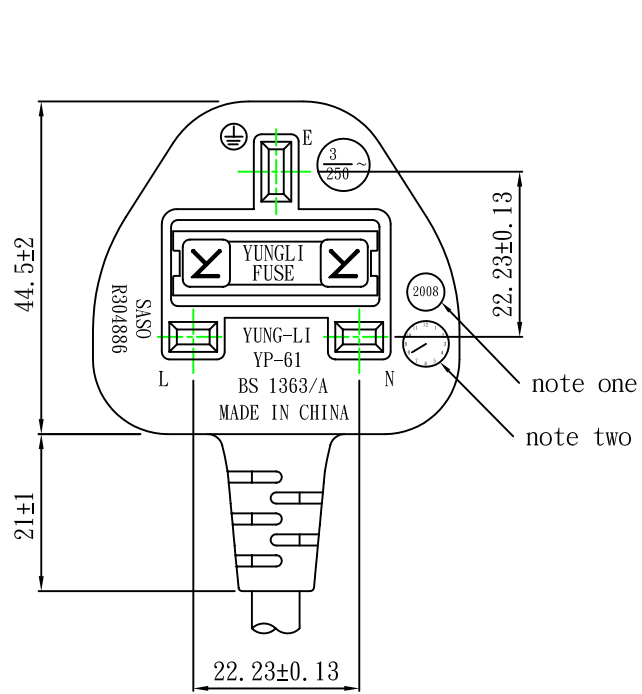

note one
note two

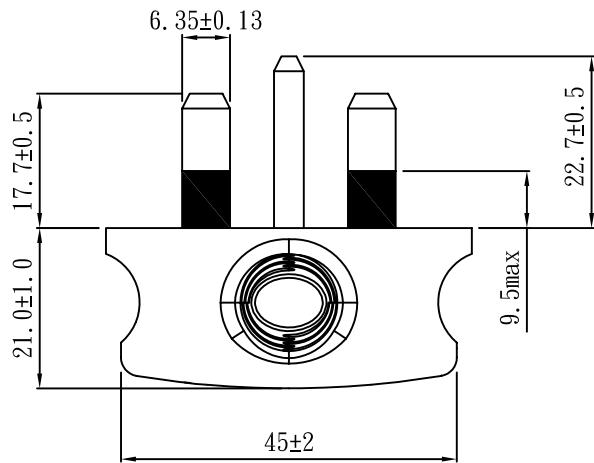
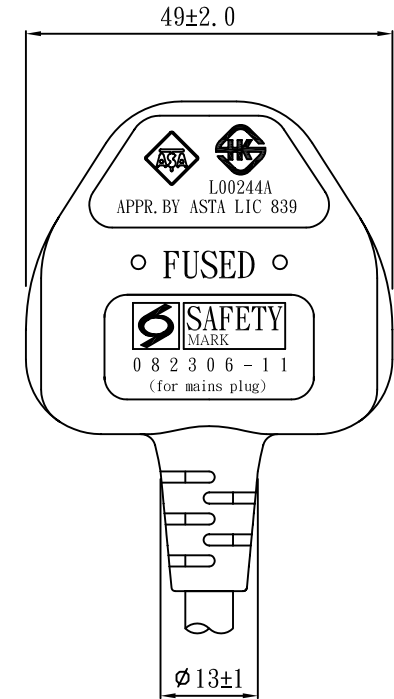
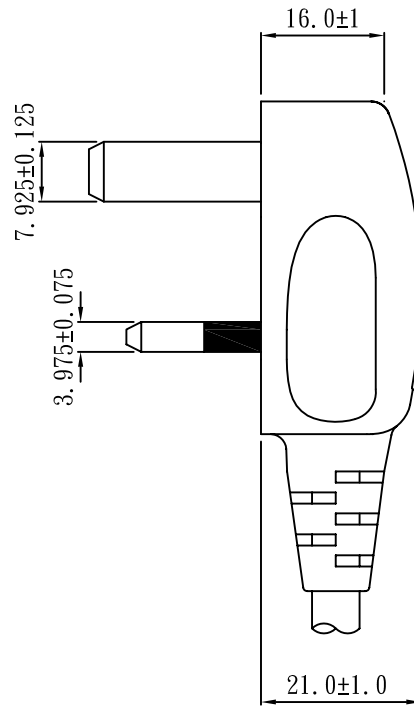

note one: production of year. (must be changed every year)

note two: production of month point (must be changed every month)

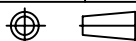
TOLERANCE >0±0.30 >1.0±0.50 >10.0±1.0 >20.0±2.0 Angle: ±1°	APPROVED		DATE		YUNG LI CO., LTD			
	CHECKED		DATE					
	DRAWN	FENGMEI	DATE	09.02.11	P/N			
	TYPE	YP-61(3A)			MATERIAL	P. V. C	UNIT	mm
DRAWING NO.	CY-P61B3A			SCALE	1:1			



N15371

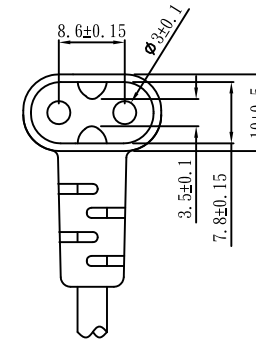
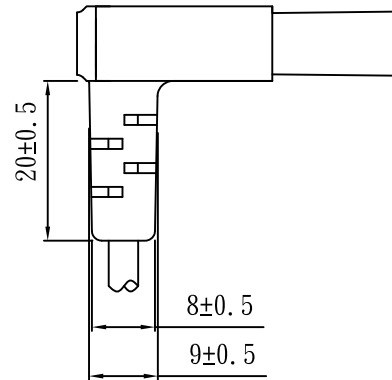
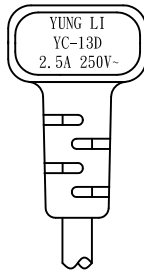
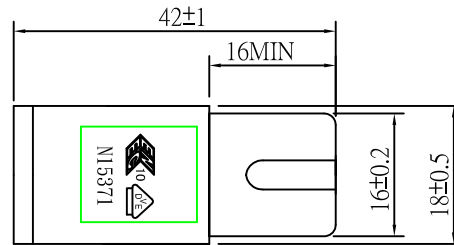

TOLERANCE >0±0.30 >1.0±0.50 >10.0±1.0 >20.0±2.0 Angle: ±1°	APPROVED		DATE		YUNG LI CO., LTD			
	CHECKED		DATE					
	DRAWN		DATE					
	TYPE	YC-13D			P/N			
	DRAWING NO.	CY-D13DCB			MATERIAL	P. V. C	UNIT	mm
				SCALE	1:1			

SPECIFICATION

TYPE DESCRIPTION	PART NO.	PAGE
YP-61/YC-13D	POWER SUPPLY CORD	1 of 3

1. SCOPE:

This specification applies to POWER SUPPLY CORDS which are in compliance with BS 1363 standards and authorized ASTA

2. Standard of applicable

No.	Item	Type	Max. voltages	Max. current	File No.
2.1	Plug	YP-61	250V	3A	
2.2	Connector	YC-13D	250V	2.5A	
2.3	Cord	H03VVH2-F 0.75/2C			

3. TEST CONDITION: This test and measurement, unless otherwise specified shall be carried out at a temperature of 15⁰C to 35⁰C, relative humidity of 25% to 85%, and atmospheric pressure of 86kpa to 106kpa.

However, when any doubt arises on the judgement value under it the test and measurement shall be carried out at a temperature of 20±2⁰C, relative humidity of 60% to 70%, and atmospheric pressure of 86kpa to 106kpa.

4.ELECTRICAL PERFORMANCE

NO.	Item	Test condition	Requirement
4-1	Dielectric Withstanding Voltage test	AC3000V is applied between a conductor and other conductor for 1 second. Loss of electric current at 1mA	No breakage
4-2	Current and Polarity test	L=L E=E N=N	No problem with Conductor
4-3	Insulation resistance test	In the air 20 ⁰ C~60 ⁰ C DC 500V	5MΩ / km MIN

SPECIFICATION

TYPE DESCRIPTION	TION	PART NO.	PAGE
YP-61/YC-13D	POWER SUPPLY CORD		2 of 3

5. MECHANICAL PERFORMANCE

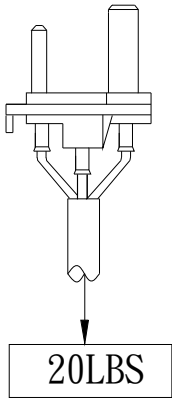
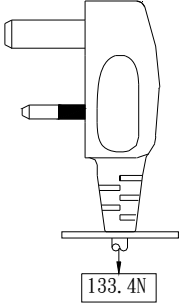
NO.	Item	Test condition	Requirement
5-1	Aging test	Exposure to $70 \pm 2^\circ\text{C}$, at atmosphere for 168 hours under natural ventilation.	No crack in locus mark wire exposure short and opposite polarity.
5-2	Input & output Force to connector	It is tested after taking the action of 10time input & output.	Applied force is 1~6kg
5-3	Pulling out force of terminal	The connection between blade terminal and conductor shall not break under a pull force of 20lbs for 1minute 	Blade can not fall down
5-4	Pulling out force of cord	The joint in flexible cord is to be securely supported by a rigid flat mounted horizontally, a pull of 133.4N weight for one minute to the flexible cord 	No looseness

SPECIFICATION

YP-61/YC-13D

POWER SUPPLY CORD

3 of 3

6.MECHANICAL PERFORMANCE

NO. Item	Test condition	Requirement
6-1 Bending force	The power supply cord division is fixing and load of 1000g is added to a tip of a cable. It is made to do 10000times bending on right and left each 45° (bending speed 60 times/minute)	Breaking rate is under 10%

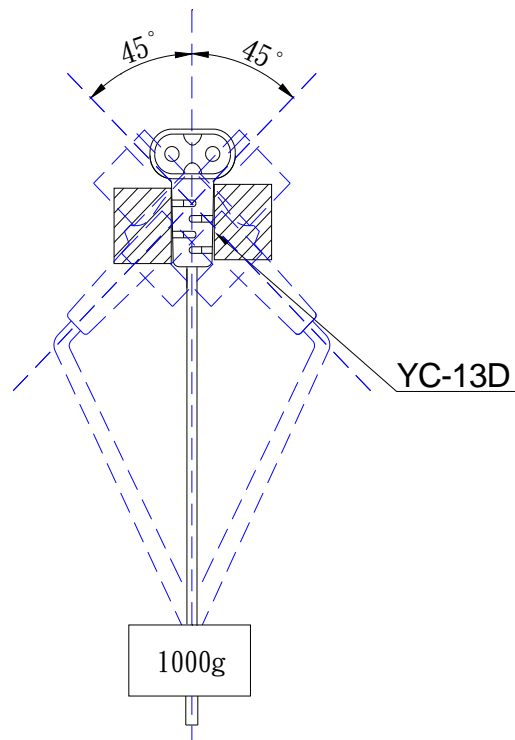

YUNG LI CO., LTD

SPECIFICATION









Yung Li	Style	PVC FLEXIBLE CORDS	Document No
2009.4.24			
Edition	Size	H03VVH2-F 2 x 0.75mm²	Page
A			1/2

1. Standard: IEC 227 IEC228

2. Construction & Dimension

	Item	Specification
Conductor	Size	2 x 0.75mm ²
	Material	Annealed Bare Copper
	Construction	24 / ϕ 0.202±0.01
Insulation	Material	PVC
	Minimum Average Thickness	0.50mm
	Minimum Thickness at any point	0.35mm
	Diameter	2.15 ± 0.10
	Identification	Blue,Brown
Core Assembly	Core Twist	2-Core
	Filler	NA
	Assembly Pair	NA
Taping	Mylar Foil	NA
Shielded	A1-Mylar Foil	NA
Drain	Material	NA
	Construction	NA
Jacket	Material	PVC
	Minimum Average Thickness	0.60mm
	Minimum Thickness at any point	0.41mm
	Overall Diameter(Approx)	3.4 ± 0.1/5.6±0.15
	Color	Any Color

Marking:

YUNG LI H03VVH2-F 2X0.75mm² <VDE> NF-USE 1347  KEMA-KEUR  <OVE>  
   IEMMEQU Q04083  A004049 60227 IEC 52(RVV) 300/300V  KTL SU01027-4001

YUNG LI CO., LTD

SPECIFICATION

Yung Li	Style	PVC FLEXIBLE CORDS	Document No
2005.09.23			
Edition	Size	H03VVH2-F 2 x 0.75mm²	Page
A			2/2

3. Electrical & Physical Properties

Item		Specification	
Rating Voltage		70°C 300V	
Conductor resistance(AT 20°C)		26.0Ω/Km MAX	
Insulation Resistance(AT 70°C)		0.010MΩ/Km Min	
Dielectric Strength		AC 2.0 KV / 15 min No Break	
Spark Test		5.0KV	
Insulation	Unaged	Tensile Strength	1500 lbs/in ² min
		Elongation	150% Min
	Aged	Tensile Strength	80~120% (80°C x 168hrs)
		Elongation	80~120% (80°C x 168hrs)
Jacket	Unaged	Tensile Strength	1500 lbs/in ² min
		Elongation	150% Min
	Aged	Tensile Strength	80~120% (80°C x 168hrs)
		Elongation	80~120% (80°C x 168hrs)
Deformation Test		70±4°C X 1hr ≤ 50%	
Cold Bend Test		-15°C x 4hr No Crack	
Heat Shock Test		150±2°C x 1hr No Crack	

Graph:

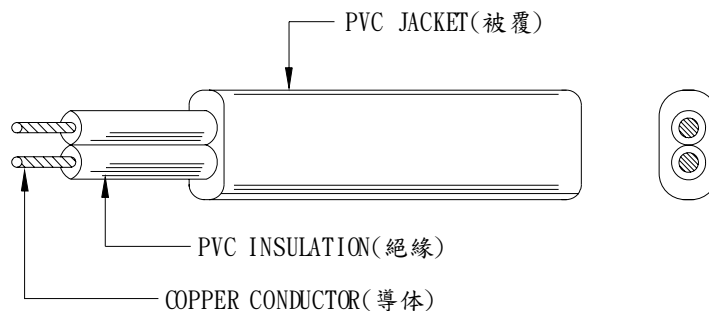



ASTA Licence



Intertek

The ASTA Diamond Mark is a symbol of electrical safety. It provides evidence for customers and authorities that Intertek has independently tested and certified the product's compliance to applicable safety standards, also that Intertek monitors production and testing to ensure subsequent production continues to comply with stated standards.

This Licence is valid until the review date or earlier if preceded by the withdrawal of the Approval Standard or otherwise withdrawn by the Certification Body. Current validity status can be confirmed by contacting:
Intertek
Hilton House,
Corporation Street,
Rugby, CV21 2DN
United Kingdom
Tel: +44 (0)1788 578435
asta@intertek.com

Details of Approved variants, components and sites are given on Endorsements to this Licence (2 pages)



010

www.intertek.com

This Licence authorises use of the

ASTA Diamond Mark

Licence No. 839

Organisation:

Yung-Li Company Limited

1F, No. 10, Lane 235, Pao Chiang Road, Hsin Tien 231, Taipei, Taiwan, R.O.C.

Product:

Designation:

Colour(s):
250 Volts a.c. 50 Hz
Non-rewirable
Solid brass pins

Fused Plug

YP-61

Black, White & Grey
13 Amperes
Rough use (BS1363/A)
Solid moulded-on construction

Approval Standard:

BS 1363-1: 1995
Incorporating Amendment Nos. 1, 2 & 3

Issue number:

3

Review date:

30th November 2014

Factory Reference:

LQ-494

R W Hayward

Name

Signature

4th December 2009

Date



PSB Singapore

**THE SINGAPORE CONSUMER PROTECTION
(SAFETY REQUIREMENTS) REGISTRATION SCHEME****CERTIFICATE OF CONFORMITY (COC)**

TO: LCT (RS Code)
Mr Ow Yeow Bung
Lacerta Pte Ltd
Blk 214, Serangoon Avenue 4
#01-88
Singapore 550214

Date of Certification : 25 November 2008
Date of Expiry : 24 November 2011
Certificate Number : 082306-11

Dear Sir/Madam,

We certify that the following controlled goods complied with the Mandatory Requirements of the Singapore Consumer Protection (Safety Requirements) Registration Scheme:

Description of controlled goods: 3 – Pin Non-Rewirable Plug

Trade Name: YUNG LI
Model Number: YP-61
Country where controlled goods are likely to be manufactured: China
Test report number: 55S052586/MLM/PKS
Testing laboratory: PSB Corporation Pte Ltd
Tested according to: SS 145 : Part 1 : 1997

Auris Liew

TÜV SÜD PSB

Important Notice:

No controlled goods can be supplied in Singapore unless they are registered with the Safety Authority. Please access www.spring.gov.sg/safety for registration procedure.



香港安全認證中心

The Hong Kong Safety Institute Ltd

HONG KONG SAFETY MARK LICENSE

License Number : L00244A

Date of Issue : 2008-06-29

Issued To : Yung Li Co. Ltd.
1st Floor, No. 10 Lane 235
Pao-chiao Road, Sin-Tien City 231
Taipei, Taiwan

The products listed below are eligible to bear the Hong Kong Safety Mark.

Issued By : Richard Fung
Managing Director

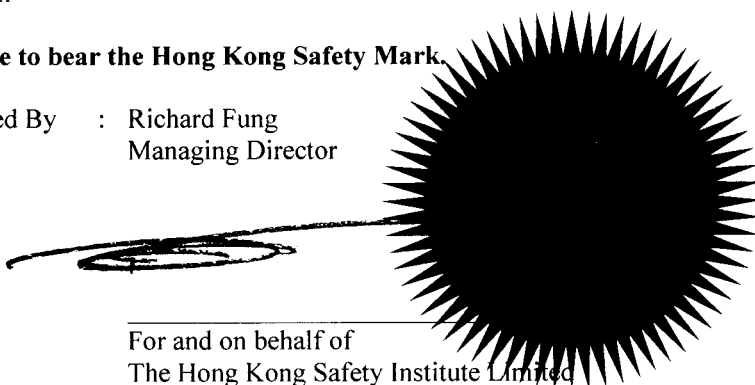

For and on behalf of
The Hong Kong Safety Institute Limited

Product Category

Wiring Accessories

Product Description

Non-rewirable fused plugs molded on power cord with/without connector

Type/Models

[Brand Name : Yung Li]

YP-60 without connector	YP-60 with connector YC-13
YP-60 with connector YC-12	YP-60 with connector YC-14
YP-61 without connector	YP-61 with connector YC-13
YP-61 with connector YC-12	YP-61 with connector YC-14

Applicable Standard(s) / Requirements

- | | |
|---|--|
| BS1363 Part 1:1995+
Amendment 1
IEC60320-1:2001 | - 13A Plugs, socket-outlets, adaptors and connection units. Part 1
Specification for rewirable and non-rewirable 13A fused plugs
- Appliance couplers for household and similar general purposes - Part 1
General requirements. |
|---|--|

The use of this License is governed by the Hong Kong Safety Mark Regulations and any other requirement and Regulations accompanying this License when issued, as amended from time to time.

This License is the property of The Hong Kong Safety Institute Limited and must be returned upon request.

Original Certification : 2005-04-29

Expiry : 2011-06-30

Cat. [III]

KINGDOM OF SAUDI ARABIA

**Product Conformity
Programme**

Statement for Registration

**ICCP ref. No. : KSA R-304886/3
Renewal**

Issued to: Yung Li Co., Ltd.
Da Pu Industrial Zone, Gang Zi Chang Ping Town
Dongguan 523571
Guangdong
China

Product: II-35 Mains Plugs, Socket Outlets and Adapters

Brand Name: YUNG-LI

Model/Type: See appendix (1 page)

Applicable standards/references: SASO 2203:2003

Issued by:

Regional Licensing Centre
Asia Pacific

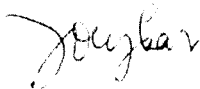

Joey Kar



This Statement for Registration is for the exclusive use of Intertek's Client and is provided pursuant to the agreement between Intertek and its Client. Intertek's responsibility and liability are limited to the terms and conditions of the agreement. Intertek assumes no liability to any party, other than to the Client in accordance with the agreement, for any loss, expense or damage occasioned by the use of this Statement for Registration. Only the Client is authorized to permit copying or distribution of this Statement for Registration and then only in its entirety. Any use of the Intertek name of the sale or advertisement of the tested material, product or service must first be approved in writing by Intertek.

Appendix to Statement for Registration

ICCP Ref. No. : KSA R304886/3

Issued: 03 December 2008

Product: II-35 Mains Plugs, Socket Outlets and Adapters

Model/Type	Information	Review Date if Verified
YP-61	PLUG 250V 13A	21-November-2011

ZEICHENGENEHMIGUNG MARKS APPROVAL

Yung-Li Co. Ltd.
Da Pu Industrial Zone
Chang Ping Town
523571 DONG GUAN CITY
Guangdong
CHINA

ist berechtigt, für ihr Produkt /
is authorized to use for their product

Gerätesteckdose, nicht-wiederanschließbar
Connector, non-rewirable

die hier abgebildeten markenrechtlich geschützten Zeichen
für die ab Blatt 2 aufgeführten Typen zu benutzen /
the legally protected Marks as shown below for the types referred to on page 2 ff.

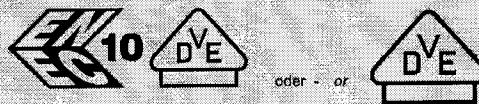

Geprüft und zertifiziert nach /
Tested and certified according to

DIN EN 60320-1 (VDE 0625-1):2008-05; EN 60320-1:2001 + A1:2007



Aktenzeichen: 1609800-1550-0005 / 117700

File ref.:

Ausweis-Nr. 40029072

Blatt 1

Certificate No.

Page

Weitere Bedingungen siehe Rückseite und Folgeblätter /
further conditions see overleaf and following pages

Offenbach, 2010-01-08

VDE Prüf- und Zertifizierungsinstitut GmbH
VDE Testing and Certification Institute
Zertifizierungsstelle / Certification

Dr. Schipper

VDE Zertifikate sind nur gültig bei Veröffentlichung unter:
VDE certificates are valid only when published on:

<http://www.vde.com/zertifikat>
<http://www.vde.com/certificate>

VDE Prüf- und Zertifizierungsinstitut

Zeichengenehmigung

Ausweis-Nr. / Blatt /
Certificate No. page
40029072 2

Name und Sitz des Genehmigungs-Inhabers / *Name and registered seat of the Certificate holder*

Yung-Li Co. Ltd., Da Pu Industrial Zone, Chang Ping Town, 523571 DONG GUAN CITY, Guangdong, CHINA

Aktenzeichen / *File ref.*

1609800-1550-0005 / 117700 / FG31 / E

Datum / *Date*

2010-01-08

Dieses Blatt gilt nur in Verbindung mit Blatt 1 des Zeichengenehmigungsausweises Nr. 40029072.
This supplement is only valid in conjunction with page 1 of the Certificate No. 40029072.

Gerätesteckdose, nicht-wiederanschließbar *Connector, non-rewirable*

Typ(en) / *Type(s)*:

- 1) YC-13
- 2) YC-13L
- 3) YC-13D

Bemessungsspannung
Rated voltage

AC 250 V

Bemessungsstrom
Rated current

2,5 A

Polzahl
Number of poles

2-polig ohne Schutzkontakt
2-pole without earthing contact

Bauart
Kind of construction

Normblatt C7
standard sheet C7

Anmerkung(en)

Remark(s)

Gerätesteckdosen ohne Schutzkontakt müssen Teil einer Geräteanschlußleitung oder einer Weiterverbindungs-Geräteanschlußleitung sein.
Connectors without earthing contact shall be part of a cord set or interconnection cord set

Produktinformation
Product information

siehe Anlage Nr. 100 + 200 + 900
see Appendix No. 100 + 200 + 900

Warenzeicheninhaber
Trademark holder

Yung Li Co. Ltd.

Fortsetzung siehe Blatt 3 /
continued on page 3

DEPARTMENT OF **FAIR TRADING**

NSW Consumer Protection Agency

CERTIFICATE OF APPROVAL

ISSUED PURSUANT TO SECTION 21C OF THE ELECTRICITY SAFETY ACT 1945

ISSUED TO:

Yung Li Co Ltd

CLASS OF ARTICLE:

Appliance Connector

DESCRIPTION OF ARTICLE:

Appliance connector for class II equipment, listed as C7 in standard sheet and integrally moulded to a 2 core flat insulated and sheathed flexible cord, 2x0.75mm sq. (HAR approved H03VVH2-F) 250V, a.c, 2.5A.

TYPE REFERENCE CODE: Type YC-13

APPROVAL MARK:

Each electrical article of the abovementioned type shall be marked with N15371

DATE OF APPROVAL: 17 September 1997

This approval expires 5 YEARS from the date of approval unless renewed or extended

for DIRECTOR-GENERAL

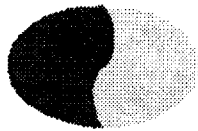

Ref: N15371/1

DEPARTMENT OF FAIR TRADING

NSW Consumer Protection Agency

RENEWAL OF CERTIFICATE OF APPROVAL No 15371

PARTICULARS OF RENEWAL

The approval of Appliance Connector Type No. YC-13 has been renewed for a period of FIVE years.

The Approval expires on 17 September 2007 unless it is renewed, extended, suspended or cancelled.

for DIRECTOR-GENERAL

16 July 2002

ZEICHENGENEHMIGUNG MARKS APPROVAL

Yung-Li Co. Ltd.
Da Pu Industrial Zone
Chang Ping Town
523571 Dong Guan City
Guangdong
CHINA

ist berechtigt, für ihr Produkt /
is authorized to use for their product

Flexible Leitung
Flexible cable (cord)

die hier abgebildeten markenrechtlich geschützten Zeichen
für die ab Blatt 2 aufgeführten Typen zu benutzen /
the legally protected Marks as shown below for the types referred to on page 2 ff.

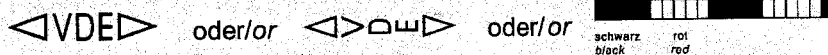

Geprüft und zertifiziert nach /
Tested and certified according to

DIN VDE 0281-5 (VDE 0281 Teil 5):2002-09; HD 21.5 S3:1994 + A1:1999 + A2:2001

VDE Prüf- und Zertifizierungsinstitut
VDE Testing and Certification Institute
Zertifizierungsstelle / Certification

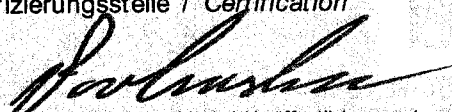
VDE Zertifikate sind nur gültig bei Veröffentlichung unter:
VDE certificates are valid only when published on:

Aktenzeichen: 1609800-5140-0005 / 82166

File ref.:

Ausweis-Nr. 40010145 Blatt 1

Certificate No. Page

Weitere Bedingungen siehe Rückseite und Folgeblätter /
further conditions see overleaf and following pages

Offenbach, 2004-04-27
(letzte Änderung/updated 2007-02-22)

<http://www.vde.com/zertifikat>
<http://www.vde.com/certificate>

VDE Prüf- und Zertifizierungsinstitut Zeichengenehmigung

Ausweis-Nr. / Blatt /
Certificate No. page
40010145 2

Name und Sitz des Genehmigungs-Inhabers / *Name and registered seat of the Certificate holder*

Yung-Li Co. Ltd., Da Pu Industrial Zone, Chang Ping Town, 523571 Dong Guan City, Guangdong,
CHINA

Aktenzeichen / *File ref.*

1609800-5140-0005 / 82166 / FG42 / STR

letzte Änderung / *updated* Datum / *Date*

2007-02-22

2004-04-27

Dieses Blatt gilt nur in Verbindung mit Blatt 1 des Zeichengenehmigungsausweises Nr. 40010145.
This supplement is only valid in conjunction with page 1 of the Certificate No. 40010145.

Flexible Leitung *Flexible cable (cord)*

Typ(en) / *Type(s)*:

H03VV-F 2...4 x 0,5...0,75 mm²

+

H03VVH2-F 2 x 0,5...0,75 mm²

+

H05VV-F 2...5 x 0,75...2,5 mm²

+

H05VVH2-F 2 x 0,75...1,0 mm²

+

Firmenzeichen

YUNG LI

Trademark

Dieser Zeichengenehmigungs-Ausweis bildet die Grundlage für die EG-Konformitätserklärung und CE-Kennzeichnung durch den Hersteller oder dessen Bevollmächtigten und bescheinigt die Konformität mit den genannten Normen im Sinne der **EG-Niederspannungsrichtlinie 2006/95/EG**.

This Marks Approval is the basis for the EC Declaration of Conformity and the CE Marking by the manufacturer or his agent and shows the conformity with the said standards as defined by the EC Low-Voltage Directive 2006/95/EC.

VDE Prüf- und Zertifizierungsinstitut
VDE Testing and Certification Institute
Fachgebiet FG42
Section FG42